

Lt7332 1-0

I 111111131 111E113

MI/

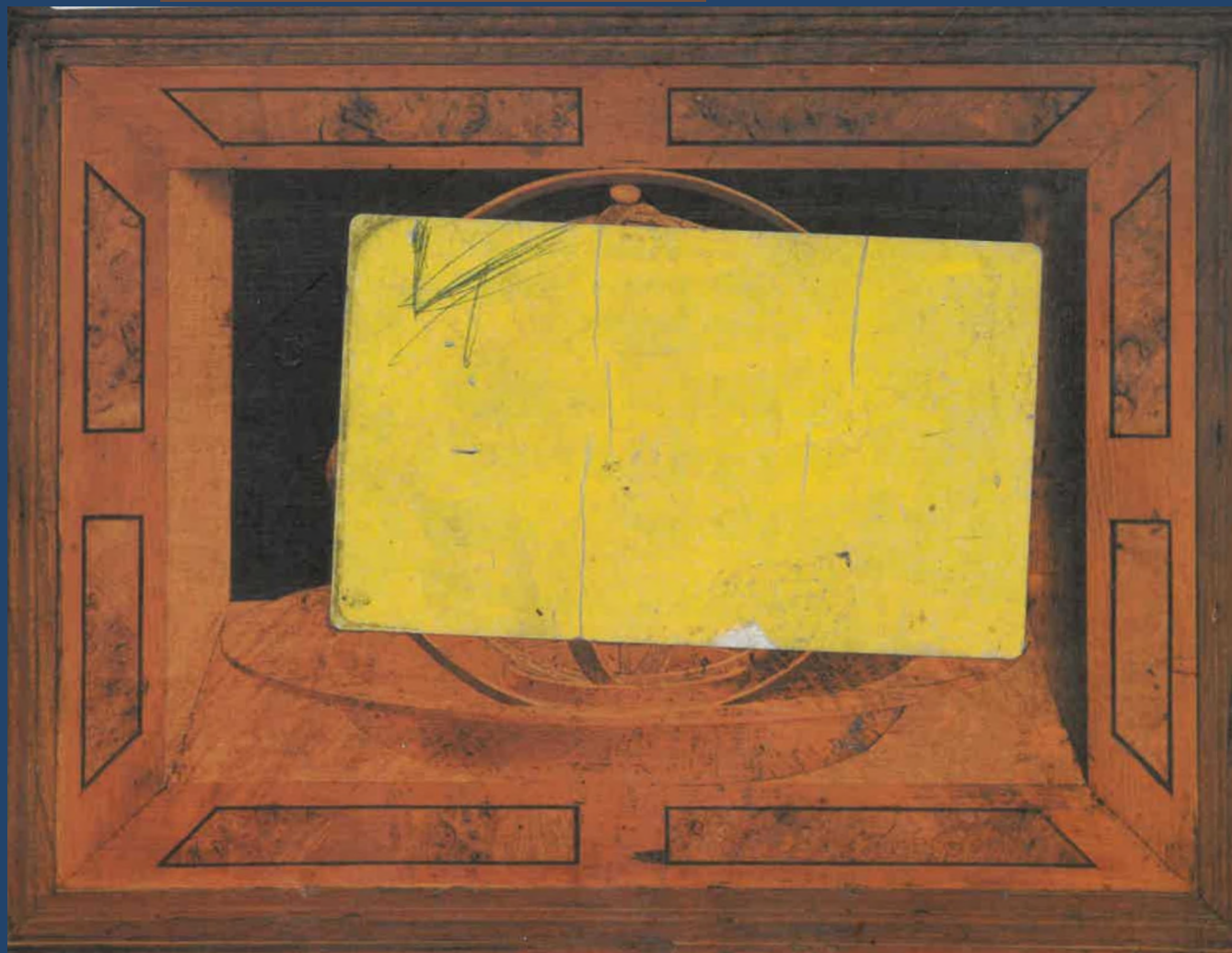

**CATALOGO GENERALE  
SANITARI-RUBINETTERIA  
ACCESSORI BAGNO-SCALDABAGNI  
| RIRGAZIONE-UTENSILERIA**



## *Metodo di consultazione del catalogo*

*Questo catalogo è composto di quattro volumi:*

- ferramenta*
- idraulica professionale*
- idraulica per l'industria*
- idraulica generale*

*Ogni volume riporta un **indice alfabetico dei prodotti** all'interno del quale sono evidenziati i riferimenti di pagina dei gruppi di articoli dei vari fornitori/produttori.*

*Nella pagina seguente si trova una "pagina tipo" del catalogo con le indicazioni utili per una consultazione rapida ed esaustiva del catalogo.*



Foto del prodotto



Tabella, grafico o altre informazioni tecniche relative al prodotto

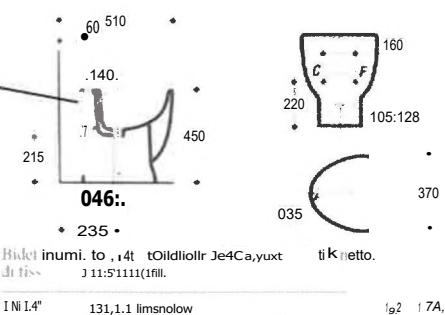

Descrizione

61133 BIDET I/F SMALL GIAN IDE Art. 04700

Codice del prodotto

Codice del fornitore/produttore



Vaso sospeso a cacciata con scarico a parete. Fui zinna con passo rapido e flussometro cassetta alta o irminghamata. Interasse di fissaggio del vaso alla parete 180 mm. Per d fissaggio a parete è necessario utilizzare l'apposito sostegno metallico da incasso. Staffaggk vedi pag. 21

61138 VASO SOSP.PAR SMALL BIA \ E Art. T347200 P/C.

Sigla identificativa del fornitore/produttore



N° di pezzi contenuti nella più piccola unità di imballo

Met sospeso monoforo con erogazione da acqua dal rubinetto, vi si possono installare sia i rubinetti monocomando che monoforo a doppio comando. Interasse di fissaggio del bidet ala parete 180 mm. Per il fissaggio a parete e necessario utilizzare tap-po . : metallico da incasso. Staffaggk vedi pag. 21

61139 BIDET SOSP. IF SMALL BIAN IDE Art. T5191000 P. 1



## ***La nostra azienda***

*Questa è l'unica pagina in cui si trova un riferimento esplicito alla nostra azienda, ed è fatta in modo che chi la volesse togliere e rendere anonimo il catalogo lo possa fare, in modo da poterlo usare come strumento di lavoro personale.*

***Il nostro numero di telefono è:***                   **0521-779911**  
***Il nostro numero di fax è:***                   **0521-273392**  
***Il nostro indirizzo e-mail è:***               **info@corbellinLit**  
***Il nostro sito internet è:***                   **www.corbellini.it**

## ***Il nostro staff***

***Centralino-vendite:***                               ***Sig.ra Renata, Sig.ra Elisa, Sig.ra Sabrina***  
***ordinazione articoli fuori catalogo:*** ***Sig.na Bruna***  
***capo magazziniere:***                           ***Sig. Franco***  
***controllo ordini in partenza:***               ***Sig. Vincenzo***  
***magazzinieri al banco:***                       ***Sig. Roberto, Sig.Dario***  
***arredo bagno:***                                   ***Sig.na Annalisa, Sig.na Alina***  
***tecnici impiantistica:***                       ***Sig. Valerio, Sig. Massimilano***  
***amministrazione:***                           ***Sig. Maurizio, sig. Federico***  
***il titolare:***                                       ***Sig. Dario Bertolini***

## ***Ringraziamenti***

*Ringraziamo tutti coloro che hanno contribuito alla realizzazione di quest'opera:  
La nostra clientela che ci ha sempre sostenuto nel corso degli anni e che oltre ad accordarci  
preferenza e fiducia, ci ha saputo consigliare dandoci modo di migliorare la gamma dei prodotti  
offerti ed il servizio.*

*Il nostro team che ci ha sempre dimostrato di credere che anche nel lavoro quotidiano si  
fondano i più alti valori umani della lealtà, della considerazione reciproca e dell'onestà.  
A tutti Voi un caloroso ringraziamento ed un augurio di buon lavoro con il  
Catalogo CORBELLINI 2001.*

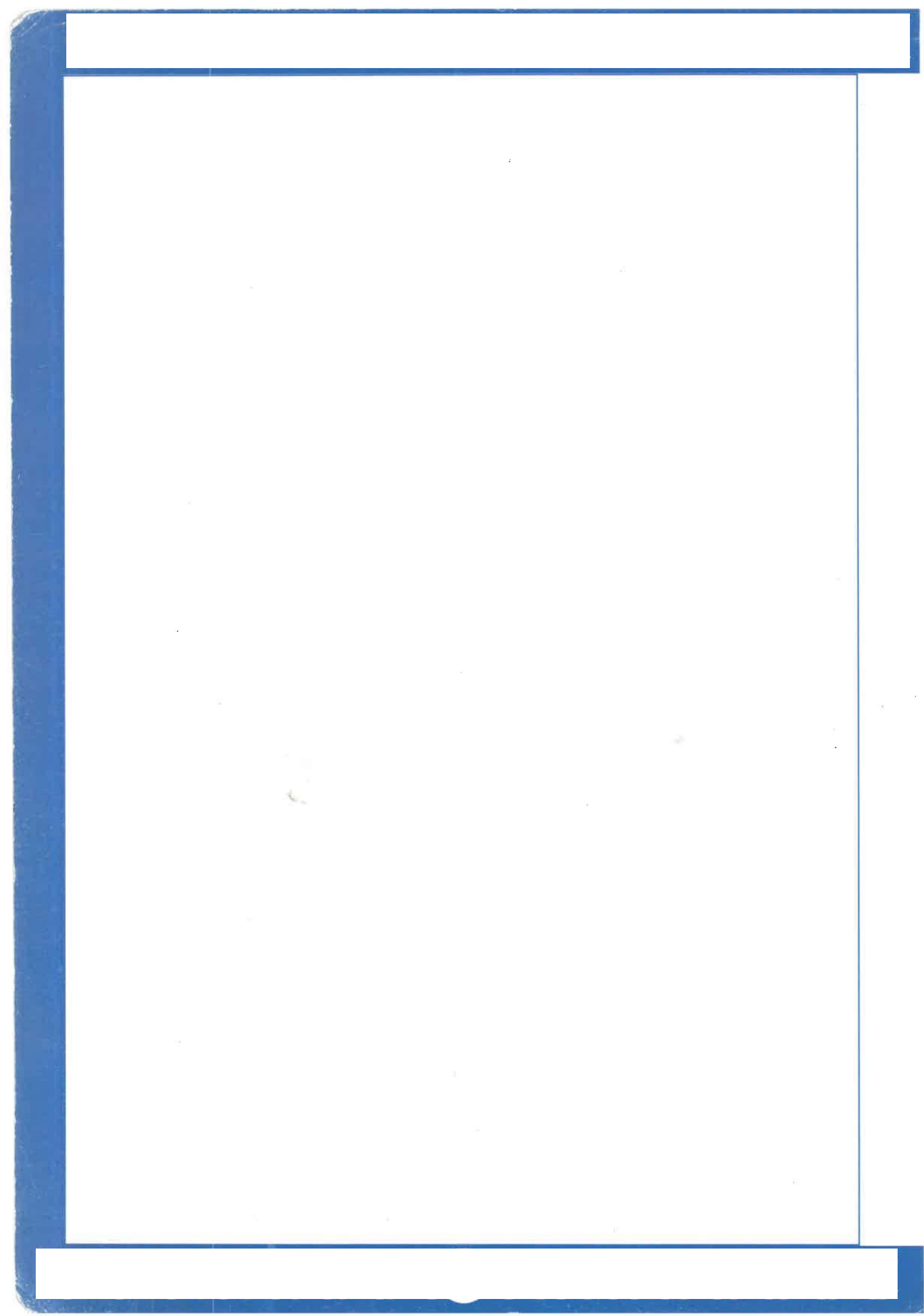



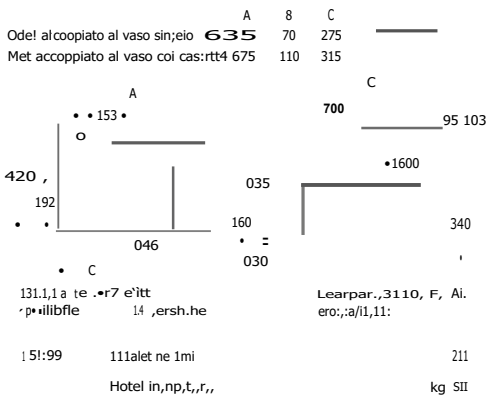

**61017 BIDET CONCA 3 FORI BIAN** IDE Art. T518000

**61018 BIDET CONCA 1 FORO BIAN** IDE Art. T528000

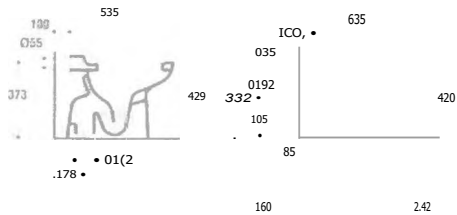

A Ca=Ciald 0,61 „a1“t., ta rak ii3141111• o a pal ,te. Numi ma a on rapir, e quer pnriata 1.2 1,ec ea,ena att a ;,anc. 9 1 in h 4•4 • o nnilurata I -carico h I In 4 sei Y. "edile a oinpletaniento del "4ppareliello e daphfihlie A riellie sta peri Vasi "I 1118:.

I<sup>1</sup> 137 'A' ..0 %:i rum a par i mcnw l.

I<sup>1</sup> 155 ,;arlio a parete

I 1242 t'd1,e1ga A I:1111<sup>3</sup> 4011 CODXIC11143 e hatlerta l e Ih puls4nie croinah,

T3 t79 V'.1511 ...ne0 a p.h unenti. e.onpieto a,,,i.zenie „Oli cerniere , minale kg

T1 1311 5,1'0 ,,111,,:0 a parete eompleh i -edile ar oigente ;,,M.cre rontali:

**61019 VASO CONCA SC/PARETE BIAN** IDE Art. T318500

**Ceramica Ideai Standard Sanitari Serie Linda**



**41** *Idea Sinititekrd*

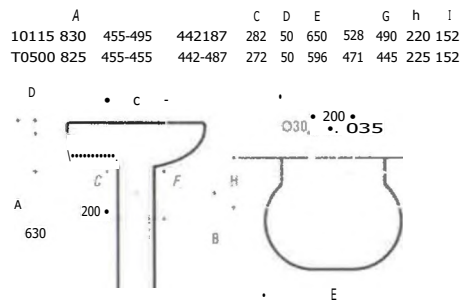

14 101-111'Iteria ..entrale aperto e laterali diatrattionati. i li ribaditale ma ruhrfelt iihholohudre d ;R• 1,0 Il /Mai. r'1.1. .ere oustpletat, ,,,0i

Uilhb I. "n i IV Lo I'

I : Salm. I id• h, I

**61022 LAVABO LINDA 65 BIAN** IDE Art. T011600

**61021 LAVABO LINDA cm 60 BIAN** IDE Art. T0500

**61023 COLONNA LINDA BIAN** IDE Art. T009300

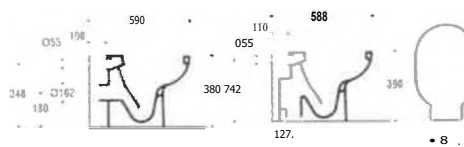

I'A - , ;Ardi i:0--- 411.111 I•1<sup>3</sup>11, d4 - tha ecario 9i n1 •e, n •hall. naZa h ni il .htnpiednt,::',..kirarratit.4 h 10 dil•i11h1k rK 4' 11-4ggh• pa' 1104111i

I il III 5a•4i• ai pa::1:149111+ Li'11, ,•011.q1Cr111 L•111all

I 41112 54•0 t41:0 a parete •011iPMenti i:0111all

**61024 VASO LINDA PAVIMENTO BIAN** IDE Art. T301100





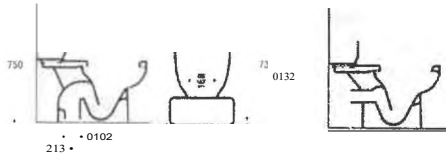

**61037** BIDET LIUTO 3 FORI BIAN IDE Art. T504900  
**61038** BIDET LIUTO 1 FORO BIAN IDE Art. T504800

accoppiato al vaso singolo scarico pulmelo  
 5.de: accoppiato a. vaso singolo scarico parete  
 O:el accppallo ai vaso con cassetta scarno pavinten  
 Bele: accoppiato a\* vaso con cassetta scarico parete

- 61035 VASO LIUTO MONOBLOCCO BIAN** IDE Art. T302500
- 61039 VASO LIUTO MONOBL PAR BIAN** IDE Art. T302600
- 61036 CASSETTA x LIUTO BIANCA** IDE Art. T400600



	A	B	
accoppiato al vaso singolo scarico pulmelo	580	247	10
5.de: accoppiato a. vaso singolo scarico parete	600	266	30
O:el accppallo ai vaso con cassetta scarno pavinten	695	362	124
Bele: accoppiato a* vaso con cassetta scarico parete	697	364	125

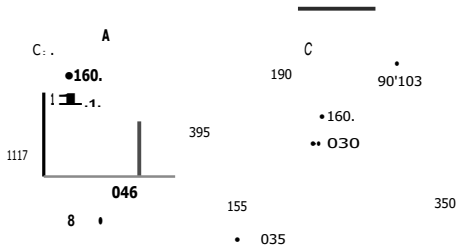

accoppiato al vaso singolo scarico pulmelo  
 5.de: accoppiato a. vaso singolo scarico parete  
 O:el accppallo ai vaso con cassetta scarno pavinten  
 Bele: accoppiato a\* vaso con cassetta scarico parete

**61037** BIDET LIUTO 3 FORI BIAN IDE Art. T504900  
**61038** BIDET LIUTO 1 FORO BIAN IDE Art. T504800

**Ceramica Idea! Standard Sanitari Serie Ellisse**



	A	B	B	C	D	E	F	C	li
10955	850	450-490	435-480	280	50	680	583	218	140
T0954	837	450-490	435-480	284	50	611	535	192	119

030... 035

A 57D H

• 200 •

- 61042 LAVABO ELISSE 68 BIAN** IDE Art. T095500
- 61041 LAVABO ELISSE 61 BIAN** IDE Art. T095400
- 61043 COLONNA ELISSE BIAN** IDE Art. T004400

**Ided Shmait441**

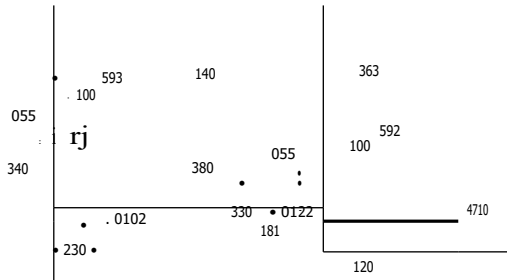

**61044 VASO ELISSE PAVIMENTO BIAN** IDE Art. T315400

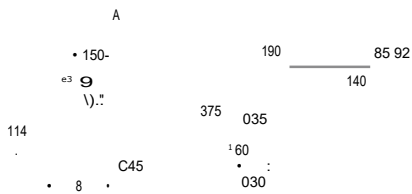

**61048 BIDET ELISSE I FORO BIAN** IDE Art. T525400

**Serie Verba**



v1

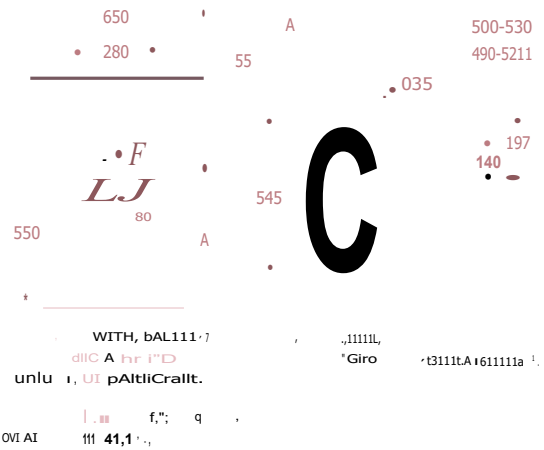

**61141 LAVABO I F VERBA 65x54 BIAN** IDE Art. T090000 P/C.

**61142 SEMICOLONNA VERBA BIAN** IDE Art. T402000 P/C.

*Ideal Standard*



V4-4-1 con 141, parci• cur•% 1,4' nerO.  
 1-1111/11d ra P,d,, iin•,,nne41,1 portma 1,2 li si  
 e4,s4.o.s afta .searko o I in P, tteè1 ti sirmiutratat',4it,,i i I in 4 ...Ce,  
 t, uppog k41,t i coa14.1 parew  
 Il %a'tt c Corredttt. t di èdile e 14•...e.,H• lint110. 44i1 n in  
 dimx,ne

it tttoi 2.3

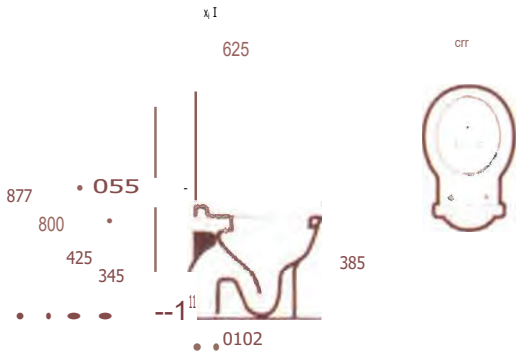

f'4-•,•tet u z4.'4, con t i12q. con

Ho, 1 414'41..

61143 VASO VERBA PAVIMENTO BIAN IDE Art. T308900 P/C.

61144 CASS ZAINO C/COP/BAT BIAN IDE Art. T408600 P/C.



ntttittitortt en ii:4' parete „to% ed i'i'igaz(i)„ deli  
 ti ii rUtinelb' si ,1114( nife =ci Mb:C(1 n?i, ighx.  
 llb:111'1101' b' a „loppio  
 11 hcikc „,rrc d.tli• d i iggi, pa i wento e tutwt  
 ih et.,11, .11.  
 3 ;ll; H tSi n. L ie.

61148 BIDET VERBA I FORO BIAN IDE Art. T504100 P/C.

*Ideai  
Sizogàriti*

*Ided  
Skoldwriti*



**Ceramica Ideai Standard Sanitari Serie Tesi**

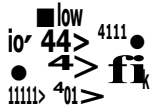

	A	B	C	D	E	F	G	H
10915	850	495-535	482.527	280	50	700	575	210 140
10902	838	495-535	482-527	275	50	647	545	215 152

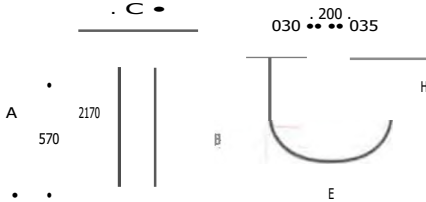

h r i r 1 U . . . . .  
 1,1 r p h l n e r n n a L e i P t a j e a p . r l u e l a t e  
 r u b i n i ,  
 h e a I n ' t o p r t  
 I I 1 . 1 % . 1 1 h ' p u . P . . . . . I I I I I I M . 1 1 P . P . P . 1 1 1 0 1 ' 1 ' 1 1 , 1  
 1 1 0 1 1 . I . o n i / w ,  
 I i v n i ) I . d ' i A h " A 2 I  
 " h . 0 1 1 i

- 61071 LAVABO TESI 70 BIAN** IDE Art. TO 91 50 0
- 61072 LAVABO TESI 65 BIAN** IDE Art. TO 90 20 0
- 61073 COLONNA LIUTO/TESI BIAN** IDE Art. TO 01 200

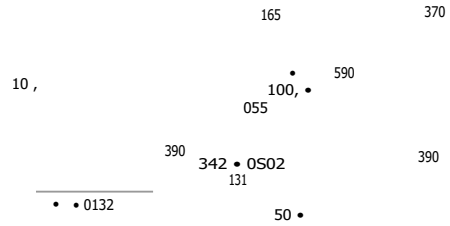

- 61074 VASO TESI PAVIMENTO BIAN** IDE Art. T303 60 0
- 61079 VASO TESI PARETE BIAN** IDE Art. T303 50 0

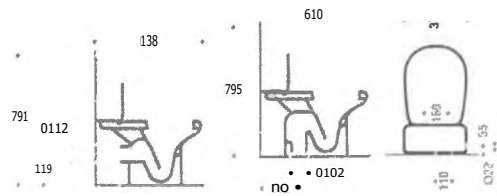

1 • a . , r e s e i t o i p o p e r , f f i l l e i l l i a r i o n t 1 1 1 1 1 1 ( b l p a s  
 f i f f i g ,

**Itied  
Sictotdatti**

- 61075 VASO TESI MONOBLOCCO BIANI** IDE Art. T303 70 0
- 61076 CASSETTA x 3037 TESI BIAN** IDE Art. T401300



09',  
5:9 1'5  
C50 113 7;14

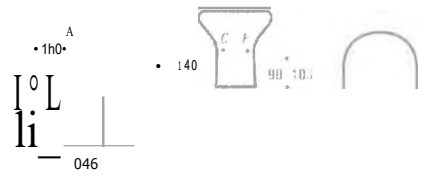

**61077 BIDET TESI 3 FORI BIAN** IDE Ad T503700  
**61078 BIDET TESI 1 FORO BIAN** IDE Art. T504000

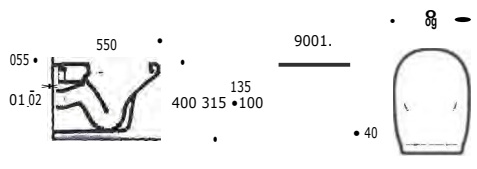

\*Vaso sospeso a cacciata coli scarico In litri, a parete. himiOna vini cassetta alta o ammirala. con Ilussoniello o passo «mulo». Per il 1,142,44w a parete è necessario uuliefare

Il sedile a coMpletainelito dell'apparecell«, e disponihile a richiesta. Interasse di 1m:zi:g.« del vaso alla [arde 1841 nOn.

k ;439 211.5  
 Ut,055t 31 Sostegno metallico  
 T1105111, Stalle ortizontali lei >omegnu kg 2,5

**Staffegg: vedi pag. 21**

**61154 VASO SOSP.NUO.TESI BIA** IDE Art. R3439

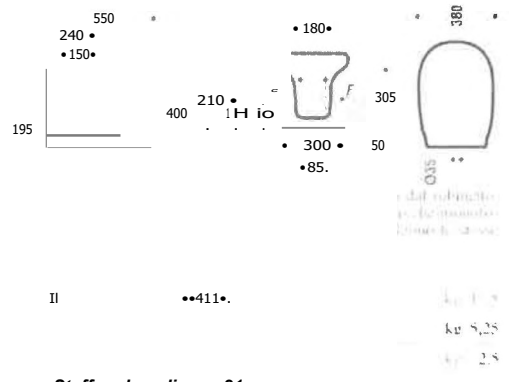

**Staffaggh vedi pag, 21**

**61155 BIDET IF.SOSP.NUO TESI BIA** IDE Art. R3739

**Ceramica ideai Standard Sanitari Serie Ala sospesa**

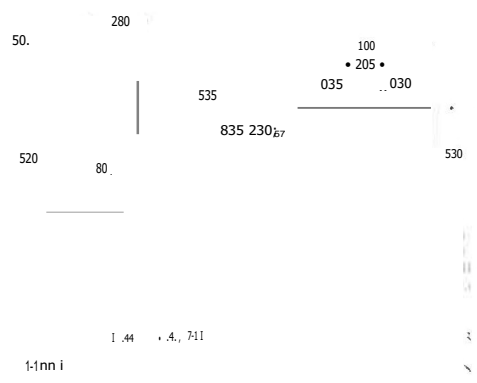

**61150 LAVABO ALA SOSPESA 70 BIAN** IDE Art. T086000

**61151 SEMICOLONNA ALA SOSP BIAN** IDE Art. T409400

**Idea/ S\*Pfdard**

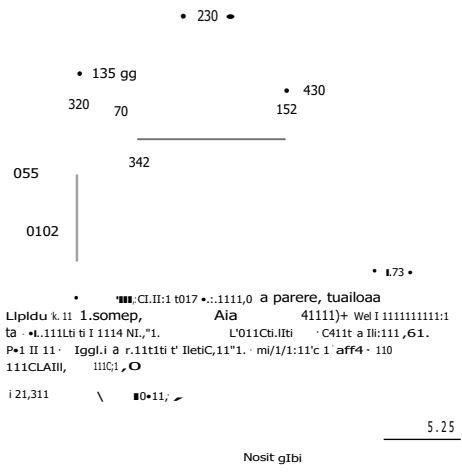

Staffaggi I: vedi pag. 21

61086 VASO ALA BIAN IDE Art. T263000

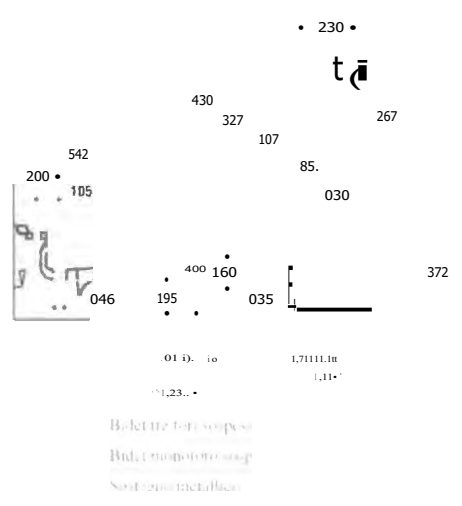

Staffaggi: vedi pag. 21

61088 BIDET ALA I FORO BIAN IDE Art. T583000

Ceramica Idea! Standard Sanitari Serie Calle



Ideal SlogiArd

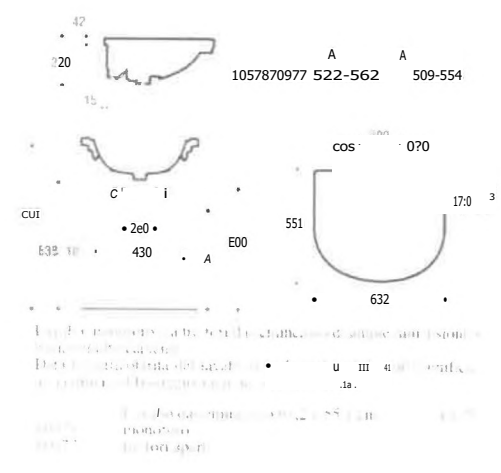

61115 LAVABO SEMINO CALLA BIANCO IDE Art. T097800

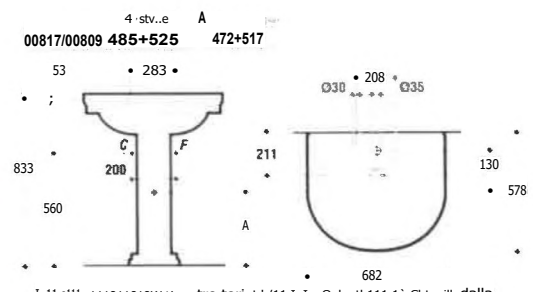

I.11 all'11111010W in tre tori t./11 InppOplenti 111.1', Chtgaili dalla xporgettia del nana ruhtnleria.  
Il lavalleh tutti 1., sere completato con la culi unta.

131517	1.a. ototot oro 118,2 \ 5 7.5 crit	kg 21
1114(5)	Lo, ah° tre tori apeni 1,5.2 : 57.5 cm	kg 23
•om4	(alunna	1,9 12

61100 LAVABO GALLA 68 BIAN IDE Art. T081700

61103 COLONNA CALLA BIAN IDE Art. T008400







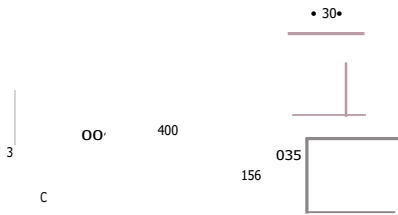

**61124 BIDET ESEDRA 1F BIAN** IDE Art. G901300  
**Ceramica Ideai Standard Sanitari Serie Fiorile**



*Ideai Standard*

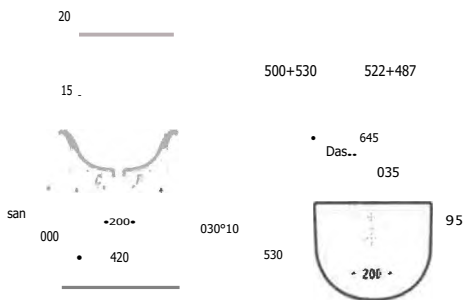

I an...ho da seinneasso con foro per la rubinetteria centrale aperto e laterali ditdrammatt, si si possono installare sia rubinetti monofora che a tre litri. Data la punieolarità del lavabo il taglio sul mobile non è unificato. la <lima e il fissaggio a parete millo a corredo. Nuovo incusso semplificato.

111853 Lavabo da sentincasso 915 04.5 cm l.g. 25

**61126 LAVABO SEMINC.FIORILE BIAN** IDE Art. T085300



	A	B	C	D	F	E	F	tf
19730	580	696	224	164	495-525	487-517	70	285 865
10735	532	645	228	167	496-530	477-522	65	284 872

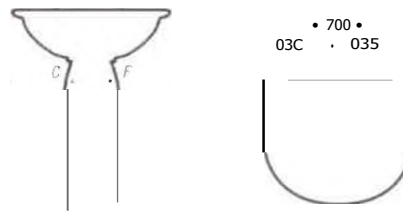

- 61125 LAVABO FIORILE 70 BIAN** IDE Art. T073000
- 61127 LAVABO FIORILE 65 BIAN** IDE Art. T073500
- 61128 COLONNA FIORILE BIAN** IDE Art. T412300

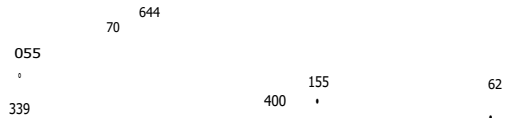

171  
 5, A ...1 011 LIO i parete ,1010 •,arkt, a pav  
 h111,10nd pa,m nqh,to e ilipca mielli, portala 1,2 l/set -  
 Li Alta .1111io \* / in +5 se, a\* ititititait ',carte° o I in 4 A F  
 t: Otit'ildh

i "Ti •Ang.10 19411-111,1110  
 rf,277 emelt• :rnsnut 1.2  
 14,5 e gt• cer•et cor,a,

**61129 VASO FIORILE PAVIMEN BIAN** IDE Art. T343100





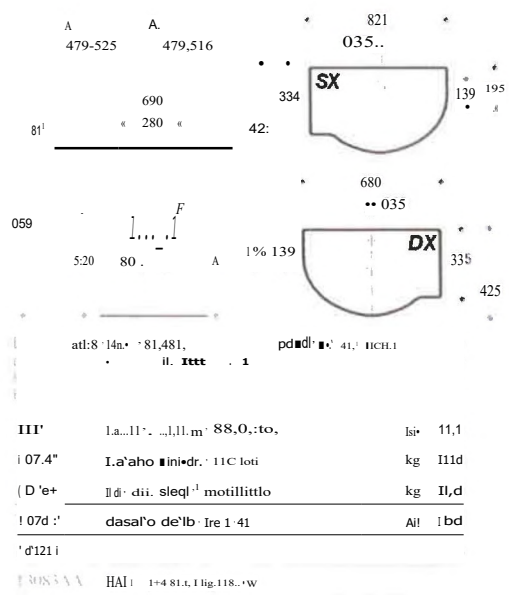

- 61007 LAVABO AN DX SMALL BIA MON IDE Art. T076000 P/C.
- 61008 LAVABO AN SX SMALL BIA MON IDE Art. T077000 P/C.
- 61132 SEMICOLONNA x LAV. SMALL BI IDE Art. T402000



*Ideal Slatiduret"*

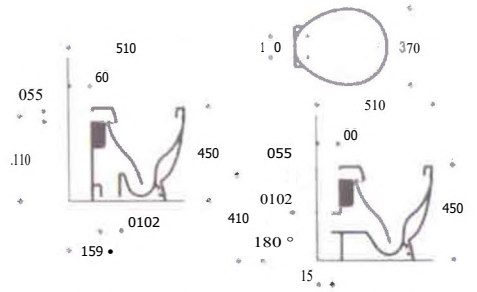

Vaso a cacciata con scarico a pavimento o a parete. Finizione con passo rapido e brisometro portata 1,2 l/sec., cassetta alta o abbassata. La pulizia del vaso è garantita anche con scarico a parete. Il vaso può essere completato con sedile a richiesta.

- T3031 Vaso con scarico a pavimento kg 20,8
- T3039 Vaso con scarico a parete kg 20,8
- T6036 Sedile kg 1,6

61134 VASO PAVIMENTO SMALL BIAN IDE Art. T303100

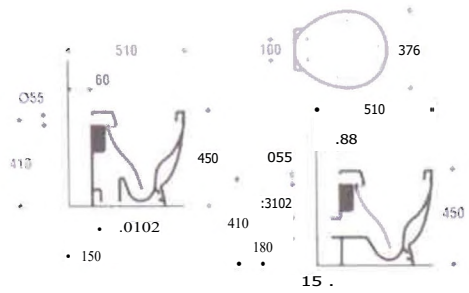

8... .dtbd. 111' 44,110 11 11410, 1  
 rde + raphlo . 1111' .riett put.ii.1 1.2 I L. thsen. AL ( i. 1111 fil.  
 . Ala. I d polli. del 2,0121 03,101 1111, nil 5t41 Uttili lit-i.  
 Il i'++Liu' i ilc 4

- T3031 Vaso con scarico a pavimento kg 20,8
- T3039 Vaso con scarico a parete kg 20,8
- T6036 Sedile kg 1,6

61009 VASO PARETE SMALL BIA IDE Art. T303900 P/C.

*Idea/ Sito, dard*



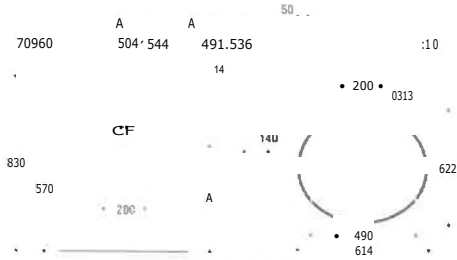

**VANITORY**

Lavabo monoforo e a tre fori con finimento in ceramica da incasso in mobile di Vitrenea Chimica. Il bordo del lavabo che appoggia sul mobile è provvisto di una canalina che deve essere riempita con una sigilla speciale.

- T0960 Lavabo monoforo (Ø 4x) 822 cm kg 18
- T0901 Lavabo tre fori aperto (Ø 4x) 822 cm kg 18

**61082 LAVABO VANITORY INCAS. BIAN** IDE Art. T096000

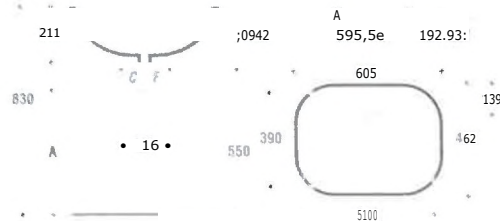

**SOTTOQUADRO**

Lavabo a bacino rettangolare da incasso totale nel mobile in Vitrenea Chimica. Il bordo del lavabo che appoggia sul mobile è provvisto di una canalina che deve essere riempita con una sigilla speciale.

- T0042 Lavabo a bacino rettangolare (Ø 4x) 822 cm kg 18
- T0043 Lavabo a bacino rettangolare (Ø 4x) 822 cm kg 18

**61083 LAVABO INCASSO SOT70Q BIAN ioE** Art. T004200

**Ceramica Idea! Standard Fireclay  
Piatti Doccia**



**Idett/'  
Siamté/rd**

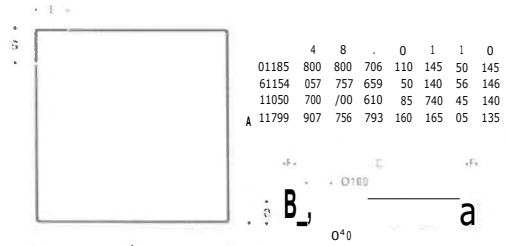

**DIDONE**

Piatto doccia in ceramica per l'installazione sopra pavimento. Superficie antiscivolo e bordo di scaneo ad angolo.

- T1185 Piatto doccia 80x70 cm kg 18
- T1184 Piatto doccia 75x75 cm kg 18
- T1189 Piatto doccia 80x85 cm kg 18
- T1187 Piatto doccia 75x85 cm kg 18

**61095 PIATTO DOCCIA DIDONE 80 B.** IDE Art. T113500

**61094 PIATTO DOCCIA DIDONE 75 B.** IDE Art. T118400

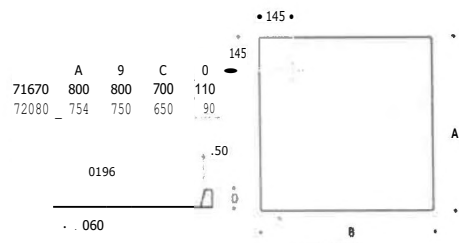
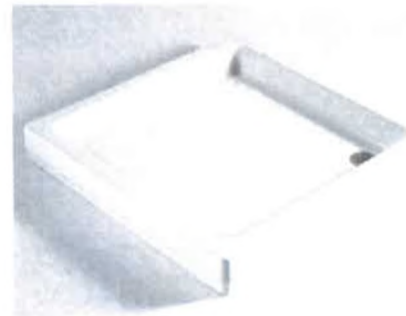

Piatto doccia in ceramica per l'installazione sopra pavimento o a Neini. Litocasso. Superficie antiscivolo e bordo di scaneo ad angolo.

- T1170 Piatto doccia 80x70 cm kg 18
- T1171 Piatto doccia 75x75 cm kg 18

**61097 PIATTO DOCCIA 80 BIAN** IDE Art. T107000

**61096 PIATTO DOCCIA 75 BIAN** IDE Art. T200000

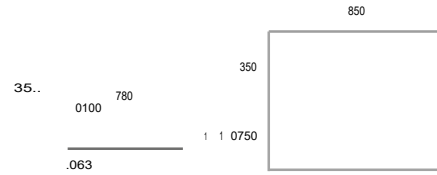

ns •  
 Pli130 •1••1•1 di 5•d1, i •alta1133,0larc J i il13iallade  
 •,triii, i.: anteain, chdo. 11 toni di scatto : al tvnit.  
 I I i Et• 7a

**61090 PIATTO DOCCIA 70x85 BIAN** IDE Art. TI 17100

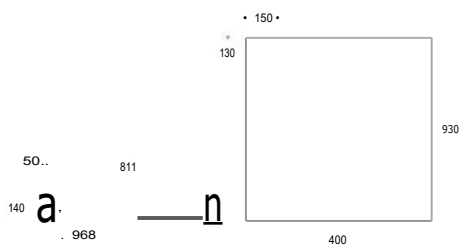

il'atio doccia di n 'ritta quadrata Inalo di qipertia ie alite.drut it • -  
 lo• Il li il i di -caria e ad alagold,  
 1107' ••01i Le 44

**61084 PIATTO DOCCIA 90x90** IDE Art. T107500

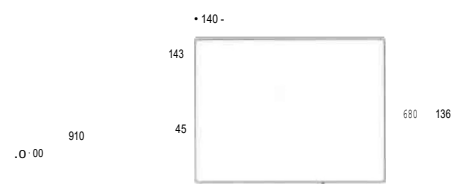
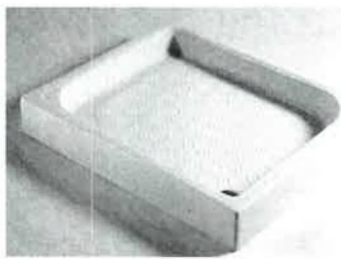

10011  
 01.010 •k9.aia di 101111.1 74:11.00.9ilare da 0•31aliale 'pia l' lia •  
 '101.11• da taipertik te antealrik, tth a a i, 0 0 ad 51,  
 11115' 11011V<sup>501</sup> V

**61087 PIATTO DOCCIA 100x75 BIAN** IDE Art. T108700

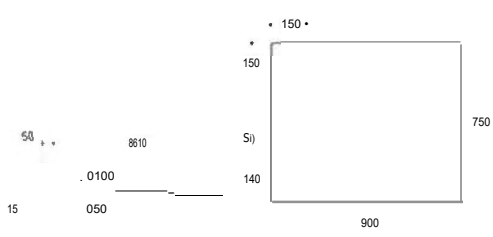

Piano doccia da installare -opra il pas :mento. Superficie anti-  
 .drucettiltt e tiini di scarico ad angolo.  
 T11105 °00 7511 kg 42

**61098 PIATTO DOCCIA 75x90 BIAN** IDE Art. T100500

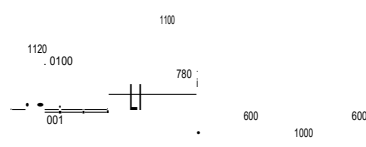
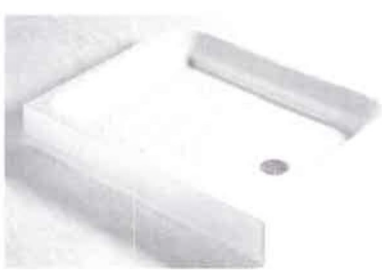

01,01• did..eia di tornio retiangolaie da iteaallare..opta il parinien  
 to. dulla' di ,upei ti, ie. ailll3•10 ,1010. Il toni di scarico i3 al ceniro  
 Ad lato da i 201 t nun.  
 l ie/, 12: 91 \ Ac bS

**61101 PIATTO DOCCIA 120X80 BIAN** IDE Art. 7107600 P/C.



	A	O	C	D	I	F	6
11176	700	110	250	800	250	800	145
11004	800	170	750	900	350	900	165

5° . . . . . 50°



**61091 PIATTO DOCCIA ANG 80 BIAN** IDE Art. T117600

**61092 PIATTO DOCCIA ANG 90 BIAN** IDE Art. T117600



	A	B	C	O	C
T1173	700	700	170	620	
T1174	800	800	190	715	



Piano doccia a bilico All-in-One ha l'irregolarità per orli, "...differente" 311111-10

11173 "181 k .14  
I 1174 NOlt

**61099 PIATTO DOCCIA 70 ALTO BIAN** IDE Art. T117300

**Idea!**  
**Sizmidia,d**

**Ceramica Ideai Standard  
Sanitari Per Comunità**

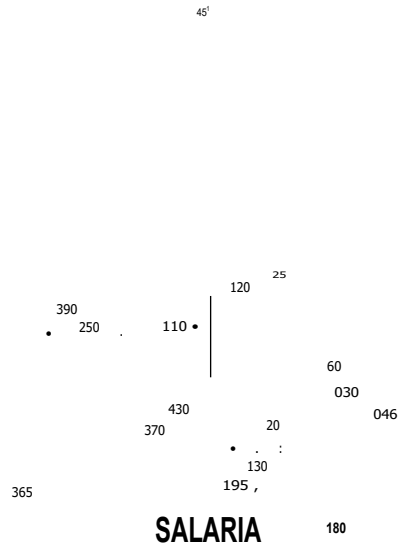

**61060 LAVABO ANG SALARIA 43 BIAN** IDE Ad T212300

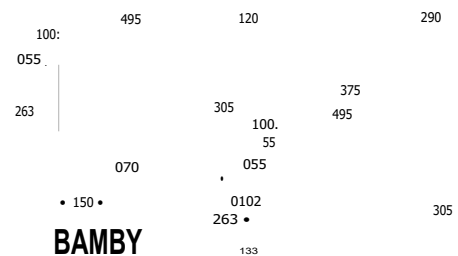

**BAMBY**

**61070 VASO BAMBY PAVIMENTO BIAN** IDE Ad. T214400



Scarico con sifone  
a bottiglia normale



*Idea/*  
**Slagaiivrd**

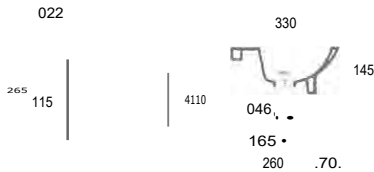

**FLAVIA**

Fontanella on tor.,  
umpiln praholte,

1212<sup>1</sup> Fontanc11a

**61080** FONTANELLA FLAVIA 40 BIAN IDE Art. T21 29 00

**73060** GRUPPO FONTANELLA UNIVERS TRE Art. 201



**COSMA**  
500

50  
•055

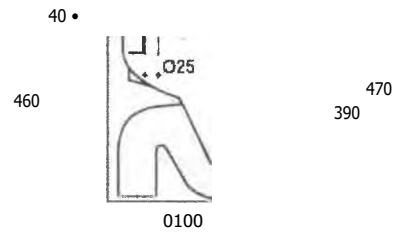

Vuot.111 t't1 rer .ii  
D14.2t) \ n•toto

24

**61160** VUOTATOLO COSMA BIAN IDE Art. T04 26 00 P/C.

**61161** GRIGLIA RIBALTAB CROMATA IDE Art. J1124AA P/C.

**Turca Idea! Standard**

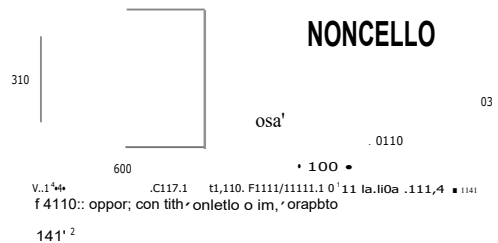

**NONCELLO**

V.1'4+ .C117.1 tl,110. F1111/11111.1 0'11 la.110a .111,4 • 1141  
f 4110:: oppor; con tith'onletto o im, 'orapbto

**61093** TURCA NONCELLO BIAN IDE Art. T41 2200

*ided*  
**Sizmi dafa'**







**PLAZA**

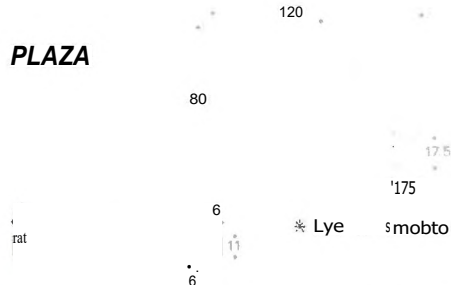

Piatto doccia smaltato su tre lati. installazione a filo o sopra pavimento. Adatto all'installazione del box doccia. Peso Kg. 40.

60807 PIATTO PLAZA 80x120 BIAN GALArt. 1012



**VENUS**

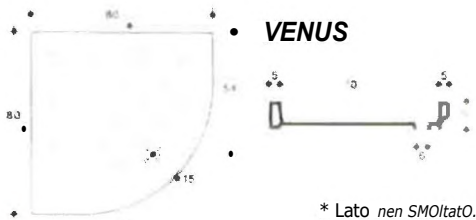

\* Lato non smaltato.

Piatto doccia ad angolo. Installazione a filo o sopra pavimento. Adatto all'installazione del box doccia. Peso Kg. 28.

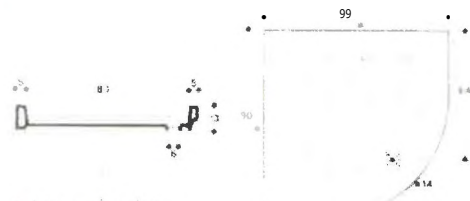

Lato non smaltato

• Piatto doccia ad angolo. Installazione a filo o sopra pavimento. Adatto all'installazione del box doccia. Peso Kg. 34.

60808 PIATTO VENUS 80 ANG BIAN GALArt. 1004

60809 PIATTO VENUS 90 ANG BIAN GALArt. 1009

**Ceramica Galassia Fireclay Lavelli E Lavatoi**

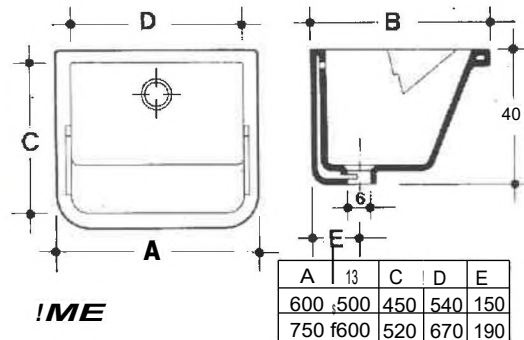
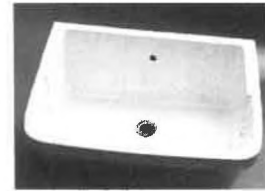

IME

60821 LAVATOIO ISIDE 60 BIAN GALArt. 2001

60822 LAVATOIO ISIDE 75 BIAN GALArt. 2002

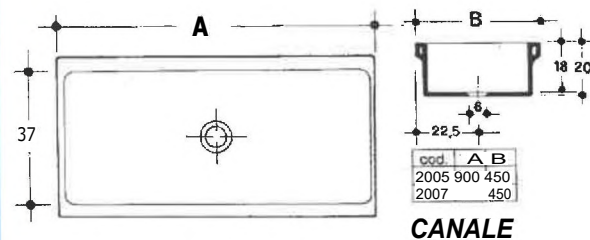

CANALE

60840 LAVATOIO CANALE 90 BIAN GALArt. 2005

60841 LAVATOIO CANALE 120 BIAN GALArt. 2007

**Ceramica Galassia Sanitari Per Comunità E Locali Pubblici**

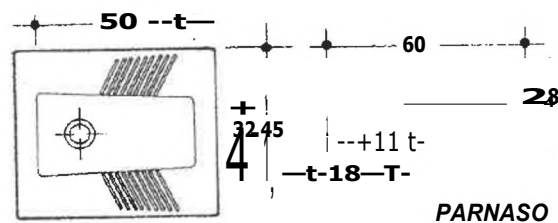

PARNASO

Vaso alla turca senza sifone a brida grondante. Montaggio a filo pavimento. Peso Kg. 14.

60844 TURCA PARNASO BIAN GALArt. 4002

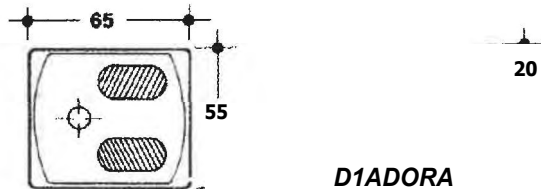

**DIADORA**

Vaso alla turca senza sifone. Funziona con cassetta alta oppure con flussometro o passorapido. Montaggio a filo pavimento. Peso Kg. 21.

**60847 TURCA DIADORA** BIAN GALArt. 4001

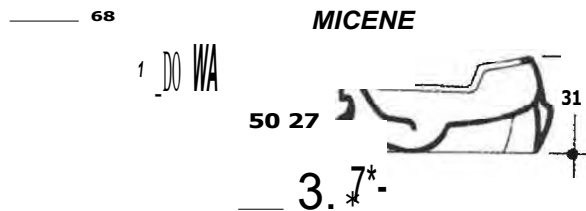

**MICENE**

Vaso alla turca sifonato. Montaggio sopra pavimento. Peso Kg. 23.

**60850 TURCA MICENE** BIAN GALArt. 4003



**Peso: 7 kg.**

**60853 ORINATOIO SIRIO** BIAN GALArt. 7001

**Ceramica Galassia Sanitari  
Lavabi Incasso**



85

350

220

50

510

**60857 LAVABO SOTTO DENISE** BIAN GALArt. 6002

**Ceramica Galassia Sanitari  
Serie Ola**



da

**Peso lavabo: 15 kg.  
Peso colonna: 9 kg.**

**60875 LAVABO cm 60 OLA** BIAN GALArt. 8101

**60876 COLONNA** OLA BIAN GALArt. 8102

**4:1,,Galassia**



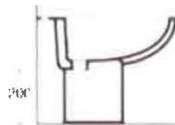

**Peso: 15 kg.**

**60877** *BIDET MONO/TRIF OLA BIAN* GALArt. 8103

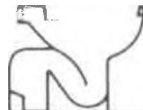

**Peso: 17 kg.**

**60878** *VASO UNI PAVIM OLA BIAN* GALArt. 8106

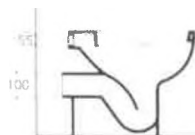

40

**Peso: 17 kg.**

**60879** *VASO UNI PARETE OLA BIAN* GALArt. 8107



**Peso vaso: 20 kg.**  
**Peso cassetta: 11 kg.**

**60885** *VASO MONOBL S/PAV OLA BIAN* GALArt. 8108

**60886** *CASSETTA MONOBL OLA BIAN* GALArt. 8110



Lavabo consolle cm 108 con bacino centrale,  
Predisposto per rubinetteria monoforo.  
Fissaggio con bulloni. Peso Kg.33.

275 t



dm.

**60859** *LAVABO ARKE CONSOLLE 108DP*

GAL Art. 8861



**60860** *PILETTA ARKE MANUALE*

GAL Art. 9572

60861 SIFONE ARKE CILIN D. 1.1/4 GAL Art. 9570



Art.8868  
Vaso scarico P/S  
Peso Kg.26

- 215 -

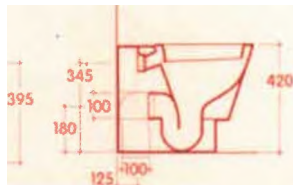

• 395

60862 VASO UNIVERSALE ARKE GAL Art. 8868

60863 SEDILE ARKE GAL Art. 8872



Bidet  
Predisposto per rubinetteria monoforo.  
Peso Kg 23

• 215



540  
395

• 5



420

60864 BIDET MONOFORO ARKE GAL Art. sass

frl", Galassia

Ceramica Olympia Sanitari  
Serie Ambra

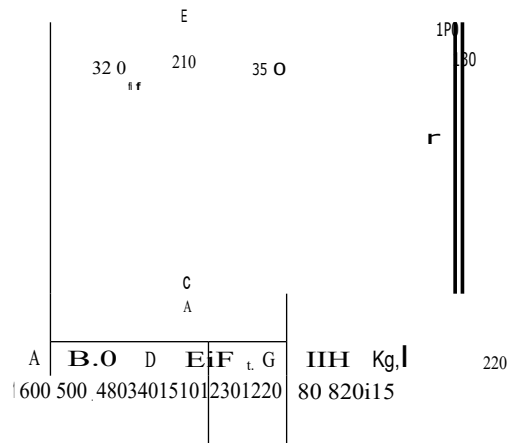

63301 LAVABO AMBRA cm 60 BIA OLYArt. 0910011

63302 COLONNA AMBRA BIA OLYArt. 1010011

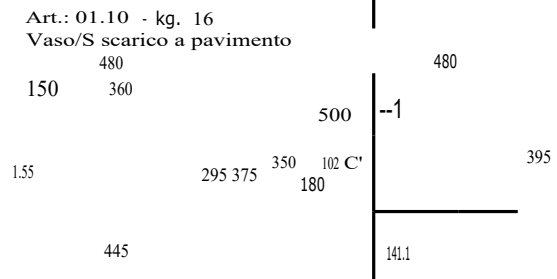

63303 VASO UNI S/PAV AMBRA BIA OLYArt. 0010011

63312 SEDILE PLASTICA AMBRA BIA out Art. C M011 P/C.5



Art.: 05.10 kg. 15  
Bidet mono o tre fori

560 200  
350 32 150

160 3/0 395  
180 45r)

**63304** BIDET MONO/TREF AMBRA BIA OLYArt. 0510011

**Accessori Universali Per  
Serie Sospese Divina**



b.

**Per bidet**

Sostegno **universale** in profilato zincato  
per bidets sospesi, completo  
di Kit per il montaggio

Dimensioni: cm L 45 x I-143 + 54 x P 8 **14**  
Interasse fori fissaggio bidet: mm 180 e mm 230  
Interasse posizione attacchi  
acqua calda e fredda: mm 90 - 210 - 310  
Confezione: singola in scatole da 5 pezzi

**60915** SOSTEGNO UNIVx BID MOD H oro Art. STFBDH 202080



**PER PARETI IN MURATURA**  
**Sostegno per Vaso** sospeso  
**Completo di kit per il fissaggio**  
**(Imballo: 5 pezzi)**

**60916** SOSTEGNO UNIVx VASO MOD P oro Art. STFVAP-502090

**PER PARETI IN MURATURA  
E IN CARTONGESSO**

**Sostegno per Vaso sospeso e  
cassetta ad incasso GEBERIT  
Completo di kit per il fissaggio**

**60919** SOSTEGNO WC + SOST CAS GEBDiv Art. STFVCM-5521



**Ricambio per parte  
frontale dei supporti  
vaso e bidet sospesi  
DIVINA**

**60930** CAPPELLOITO-RONDELLA PVC DIV Art. CCRPVC99000





Sanitari

ceramica dolomite

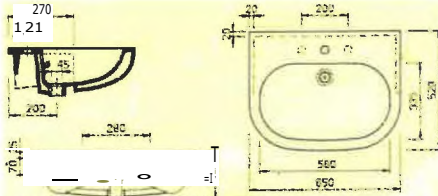

LAVABO ALPINA ART. 4475  
Lavabo serrotascio per installazione su mobile. Peso kg 17 circa.

60100 LAVABO SEMINC. ALPINA BIAN DOLArt. 4475

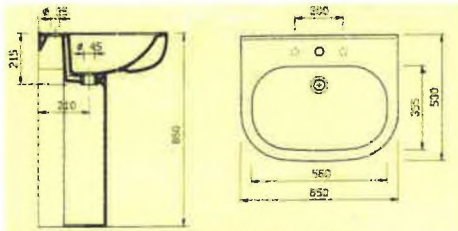

LAVABO ALPINA ART. 2600 CON COLONNA ART. 2210  
Combinazione lavabo con colonna. Il lavabo viene fissato al muro con 000 bulloni.  
Peso: lavabo kg. 20 circa - colonna kg. 9 circa

60102 LAVABO 65 ALPINA BIAN DOLArt. 2600

60113 COLONNA UNIVERSALE BIAN DOLArt. 2210



ceramica dolomite

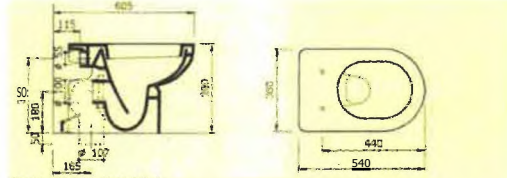

VASO ALPINA ART. 2021  
Vaso a cacciata Scarico e parete. L'erstanarare a pavimento si \*stette con apposita curva tecnica Art. 9303.11aedile può essere 1o251e dincttamente clan a Cerermca Date: nue  
Peso: 19, 20 area.

60104 VASO PAVIMENTO ALPINA BIAN DOLAct. 2621

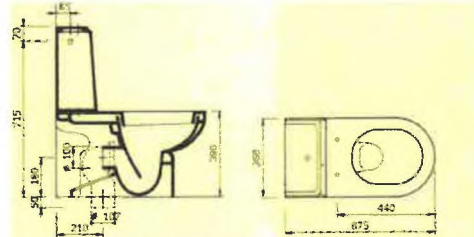

MONOBLOCCO ALPINA ART. 2629- CASSETTA ART. 2440  
V.3.r. e caccetta Scenico a parete. Aristanlzone a peirrimto 100  
cima tecnica Art. 9303. Nana ipuo essere forrito rfvettareaae data li;is seni. Lx 10  
Cassetta con ooeaczo.  
Nel: vaso kg 2 e0a.Canoelrak 3 cm

60105 VASO MONOBLOC. ALPINA B/ANDOLArt. 2625

60106 CASSETTA x QUA/ALPINA BIAN DOLArt. 2440



BIDET ALPINA ART. 2632-2634  
li Mod. 2632 a tre fon [previste] con erogazione dell'acqua a zarin 3 p ti 7.0 L.V.  
li Mod. 26344 monotono con erogazione dell'acqua dei rubinetto.  
Peso. 59,17 crea.

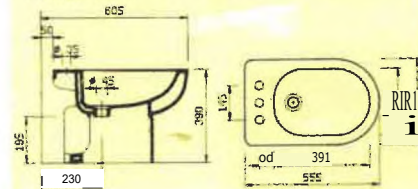

60107 BIDET 3F ALPINA BIAN DOLArt. 2632

60108 BIDET IF ALPINA BIAN DOLArt. 2634

**Ceramica Dolomite Sanitari Serie Rio**

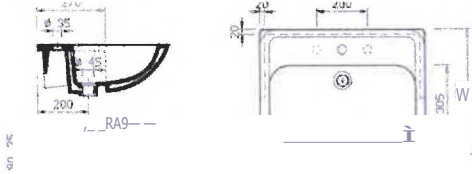

**LAVABO RIO ART. 2221**  
 Lavabo \$9, ... orie su mobile \$822 k9. 17 prce

**60110 LAVABO SEMINCASSO RIO BIAN** DOLArt, 4473

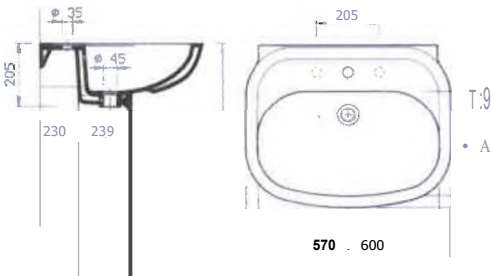

**LAVABO RIO ART. 2200/ S00 COLA COLOW** 2210  
 Cambilezione " " muro con bulloni 28 Cod. 60113)  
 Peso: lavabo

**60112 LAVABO 67 RIO BIAN** DOLArt, 2200



**ceramica dolomite**

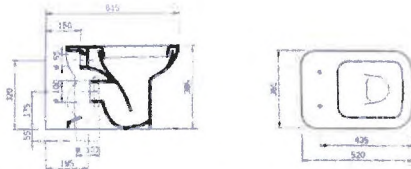

**VASO RIO ART. 2221**  
 Vaso a cacciato scarico a pessa Leatallabona a pavinienio 90190100001'ammala or,\* rampa ARI 9303 h sedAs pot:forma ~mamma dea\* Ganace. 3n10mae Paao k4 20 19019

**60114 VASO PAVIMENTO RIO BIAN** DOLArt, 2221



**MONOBLOCCO RIO ART. 2225 - CASSETTA ART. 2240**  
 Vaso a wicmta, Scarico a parete  
 V0001a5adone a p801009013 19 ~SUA con rappogh  
 curva Idcruca ART 9303.  
 Il sedie ooc MA% IC0140 ~Unente cia5a Ceramica 0010nite.  
 Cassetta con coowdic.  
 Rea.: vaso kg 22 rzza C-ss, setia kg, 10cc5.

**60115 VASO MONOBLOCCO RIO B/ANDoiArt 2225**

**60116 CASSETTA x 2224 RIO BIAN** DOLArt, 2240

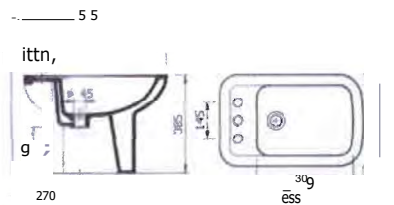

**gesT RIO ARI 222 /2724**  
 Mad 2 "nazione doli accos dal Atostto  
 MOSI, Peoe kg

**60117 BIDET 3F RIO BIAN** DOLArt, 2232

**60118 BIDET IF RIO BIAN** DOLArt, 2234

**ceramica dolomite**

**Ceramica Dolomite Sanitari  
Serie Petra**

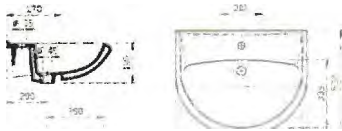

**LAVABO PETRA ART. 4463**  
Lava00 S4\*Thry %Wvtr  
Perm, l g 20 ctret

**60129 LAVABO SEMJN PETRA BIAN** DOLArt. 4463



LAVABO PETRA ART. 4485 CON COLONNA ARI. MIO EMCOLm4P.AART. =1

**60130 LAVABO 90 PETRA BIAN** DOLArt. 4465

**60131 COLONNA PETRA BIAN** DOLArt. 3810



**Per vecchi modelli  
PETRA cm. 90 con  
solo 2 fori per il montaggio**

**60138 MENSOLA SUPP x LAV PETRA** DOLArt. 3820

**ceramka dolomite**



**e.,,**

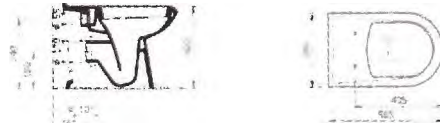

**VASO PETRA ART. 3821**  
V.,, a Citava f. carta try: t  
r13! :aziva, p:- rtte\* 19 s ,\*\*\*\*\*,, c5r tappo, t r t,R 9320.  
9932; ltu aaa:: l::htu ct g,t12,!!!:ntt: clia: a egvattra >At5rr.93  
Pete, lsg. lvt

**60135 VASO UNIV PETRA BIAN** DOLArt. 3821



**MONOBLOCCO PETRA ART. 3825- CASSETTA ART. 3842**  
v450 o cacraa!) Scanao l mt'veat ne a , 2t, rcc' cs. 7 t:  
cava 'errata ad \*v:(5- T5dlpraV ti,en- trgpV:ct-l drce::t- r33a \*t. 7ie \*  
Calvaetta Lxager  
Peao, kg. 25 rea aztta vg tt- lAra

**60137 VASO MONOBL PETRA BIAN** DOLArt. 3825

**60139 CASS MONOBL PETRA BIAN** DOLArt. 3840



**ceramica dolomite**



**BIDET PETRA ART. 1922/3874**  
3852 t5,1de pie9,2o  
li Med  
Peri ed 17 cl/s.i

**60134 BIDET 1F PETRA BIAN** DOLArt. 3834

**Ceramica Dolomite Sanitari**  
**Serie Perla**

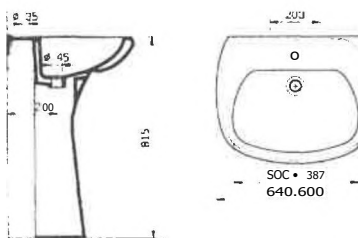

**LAVABO PERLA ART. 2802/2803 CON COLONNA ART. 2510**  
701711011 a,011P 1,1Vab0 coi colonna i lavab0 viene ferale al n9.ro r,o,un'h e  
\*Oso Laval,00mS1kvi 15 crea lawutavcrndti4n '4 r n, ku

**60140 LAVABO 60 PERLA BIAN** DOLArt. 2803

**60141 LAVABO 64 PERLA BIAN** DOLArt. 2802

**60143 COLONNA PERLA BIAN** DOLArt. 2510

**ceramica dolomite**

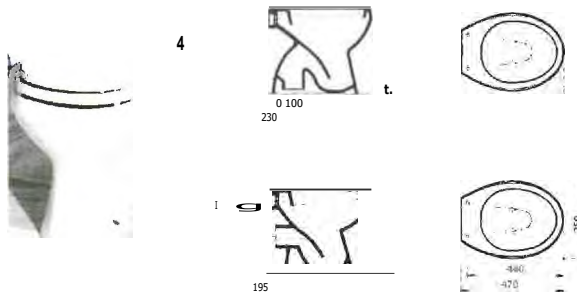

**60144 VASO PAVIMENTO PERLA BIAN** DOLArt. 2819

**60145 VASO PARETE PERLA BIAN** DOLArt. 2821

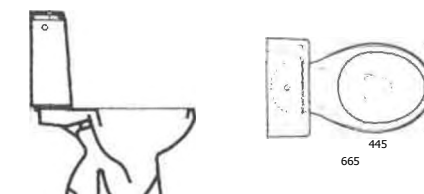

log: **MONOBLOCCO PERLA ART. 2824/2825 - CASSETTA**  
Vaso a cacciata Mod. 2824 scanso di Mod 7823 072105 I'  
O Sedile 17710 orne direttamente dolo elancien loolee'ette,  
Cassetta 1' - a cepen11.0  
Ilee 041 0 : 9. 1.1 711011 CaS' ett, 'h ho II', cura

**60146 VASO MONOBLOCCO PERLA BIAN** DOL Art. 2824

**60136 CASSETTA x PERL/CORAL BIAN** DOL Art. 2945

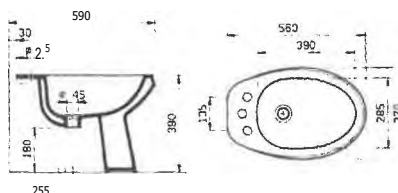

**BIDET PERLA ART. 2832/2834**  
Mod. 2837 a Ire fon e previsto celo erog1130ne dell'nedue a :181571110 Paroble -  
li Med. 283\*1 0 monolore une eroda.node tinO legna rohnene  
Pese: ve 13 circa

**60148 BIDET 3F PERLA BIAN** DOLArt. 2832

**60149 BIDET 1F PERLA BIAN** DOLArt. 2834

**Ceramica Dolomiti, Sanitari Serie Zagara**

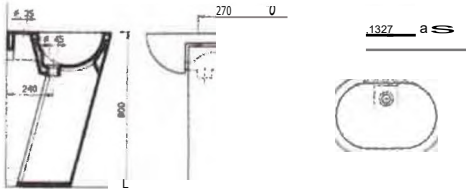

LAVABO ZAGARA ART. 3200 CON COLONNA ALI. CI O  
Carnonara I meo can omnia ~C> ~m Mono • muro con NOM.  
kmito N. 20 ace ceto. N 17 mos.

- 60162 LAVABO 72 ZAGAR BIAN**      **DOLArt. 3200**  
**60163 COLONNA ZAGAR BIAN**      **DOLArt. 3210**

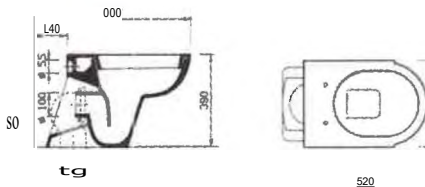

**VASO ZAGARA ART. 3221**  
Valsa a cacciata. Scarico e penale lristatazione e ~mento ai effettua con apposita  
curva tecnica ART. 9303 n seciAa 8 fccr, to orettamente data Cerarrizza Oelcrite.  
P003: Kg. 24 circa

- 60164 VASO ZAGAR BIAN**      **DOLArt. 3223**

**ceramica dolomite**

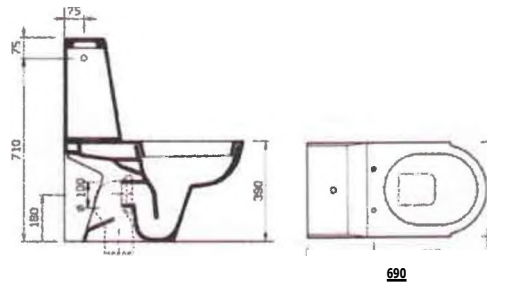

**MONOBLOCCO ZAGARA - CASSETTA ART. 3240**  
Vaso e cacciata Scatto a potete. L'installazione a prunzie a+ effettua can reposita  
curve 1~3 ART. 9303 Cmgetto cori coperCha.  
POSO vaso Kg. 27 crea - cassetta Kg 12 crea

- 60165 VASO MONOBL.ZAGAR C/SED BI DoL**      Art. 3227  
**60166 CASSETTA MONOBL.ZAGAR BIAN DoL**      Art. 3240

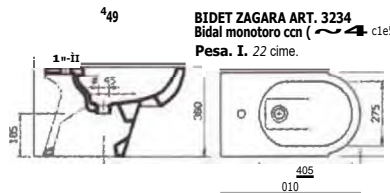

- 60168 BIDET IF ZAGAR BIAN**      **DOLArt. 3234**

**ceramica dolomil'a**

**Ceramica Dolomite Sanitari  
Serie Clodia**



LAVABO CLOD1A ART. 4480  
Lavabo 30Rk-c0s90 pa• mtEttzorto su -reb5) 00

**60172 LAVABO SEMINC. CLODIA BIAN** DOLArt. 4480

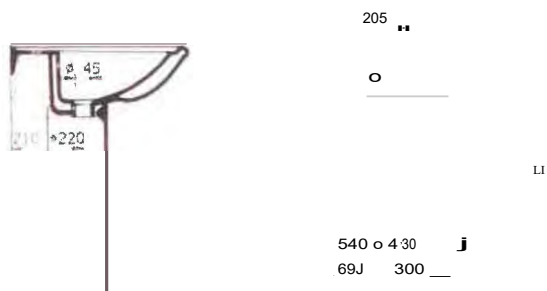

LAVABO CLODIA ART. 3400 -3401 - CON COLONNA ART. 2210 (vedi pag. 28)  
mitmwono lavabo mr• covv.tvi ..num -os- ho viro K j.

**60170 LAVABO 67 CLODIA BIAN** DOLArt. 3400



0480 010 o. ATY1 3421

**60174 VASO UNIV CLODIA C/SED B** DOLArt. 3421WS

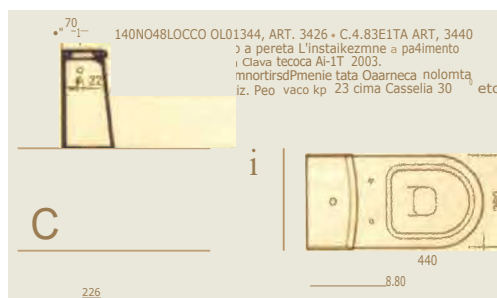

**60177 VASO MONOBL. CLODIA C/SED** BDOLArt. 3426

**60178 CASSETTA x MON. CLODIA BIAN** DOLArt. 3440

**ceramica dolomite**

**ceramica dolomite**



o 35 200

LAVABO CLOBIA ARO 11"R. 480  
505

**60173 LAVABO INCASSO CLODIA BIAN** DOLArt. 4468



LAVATO Sibilia AM. 447W4471  
4471107 pila "Integrale" BOOM O 011. Om. O'Opser,  
Oialto 10" 447,145 1. 4 6/1000 CI

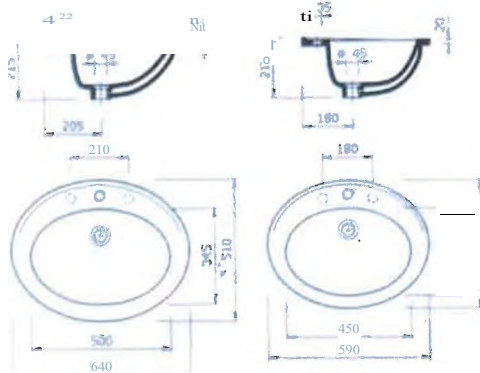

**60184 LAVABO SELLA 58x45 BIAN** DOLArt. 4471

**60185 LAVABO SELLA 65x51 BIAN** DOLArt. 4470

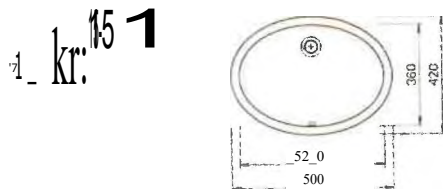

LAVABOABORDO ART. 2908  
Lavabo p 4 intahrtong sotto il prino ool  
8 clica.

**60186 LAVABO AGORDO SOTTOP BIAN** DOL Art. 2908

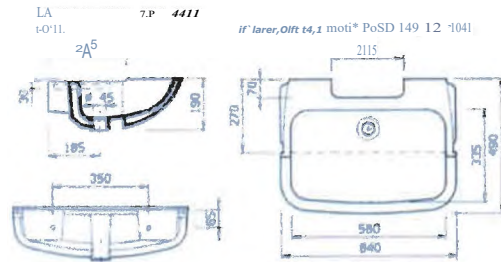

**60187 LAVABO SEMINC. TOVEL BIAN** DOLArt. 4419

**Ceramica Dolomite Sanitari  
Lavabi Piccole Dimensioni**

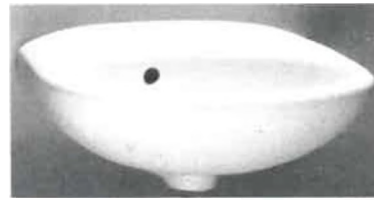

ZCZ

LAVAMANI MADDALENA ART. 5421

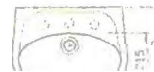

400

**60180 LAVAMANI MADDAL. 46x34 BIAN** DOLArt. 5421

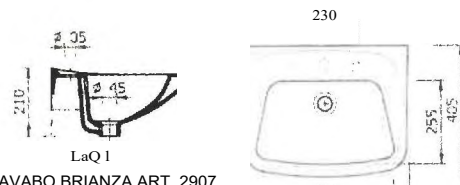

LAVABO BRIANZA ART. 2907  
110109a2 cr1.9 con t ieni.  
Peel: j. 1 erCg.

420

520

**60181 LAVABO BRIANZA 52x41 BIAN** DOLArt 2907



**Ceramica Dolomite Sanitari Per Comunità E Locali Pubblici**

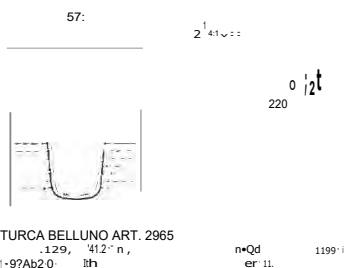

**60190 TURCA BELLUNO BIAN** DOLArt. 2965



**60705 TURCA ARGENTINA** DOLArt 4290

**60706 SIFONE x TURCA ARGEIVT §100** DOLArt. 17710A2

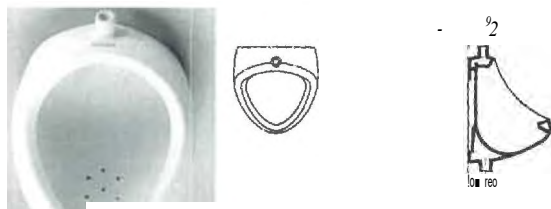

ORINATOIO BADIA ART. 2955\_

**60192 ORINATOIO BADIA BIAN** DOLArt. 2955

**ceramica dolomite**



**Romania**

Lavapiedi con poggiaiedi. Per palestre, scuole, comunità.  
Peso: kg. 25 circa.

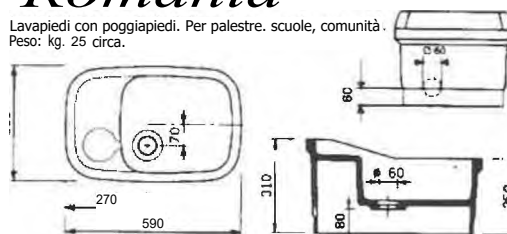

**60709 LAVAPIEDI ROMANIA BIAN** DOL Art. 4690 P/C.



CA2.5j::TTA CORTINA 2040

**60194 CASSETTA CORTINA BIAN** DOLArt. 2940

**Accessori Per Ceramica Dolomite**



**60650 ANELLO TRII' §25 CROMATO** DOLArt. 9301C

**60651 ANELLO TR/P §20 CROMATO** DOLArt. 9300

**60652 ANELLO TR/P §20 DORATO** DOLArt. 9303

**0**

**Per tutte le serie DOLOMITE  
tranne la serie PERLA**

**60797 CURVA TECNICA PER VASI** DOLArt. 9303



**Per lavelli, lavatoi e  
pillozzi DOLOMITE  
ormai fuori produzione.**

**dolornte**

**60799 SET TROPPO PIENO** DOLArt. 9862

**Ceramica Dolomite Fireclay  
Lavali! E Lavatoi**

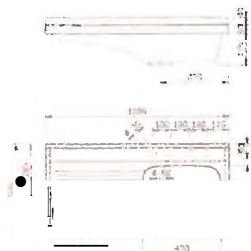

TURCHIA 487, 4437 DX 4438 SX  
Molto adatto all'installazione su molarie Disosierre certi  
rusea  
Peso kg 40.

**60729 LAVELLO TURCHIA 100 DESTRO** DOLArt. 4437

**60730 LAVELLO TURCHIA 100 SINIS.** DOLArt. 4438

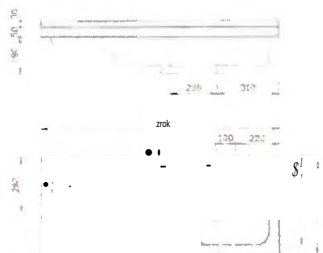
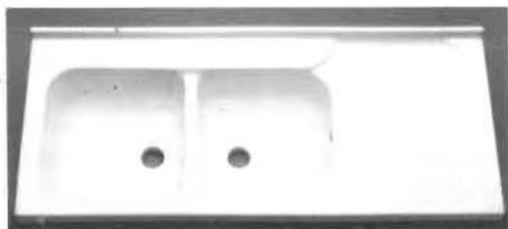

ARNO ART. 4284 DX 4295 SX  
Adatto all'installazione su 0148910 risponde con lo scalaprattra a destra e a sinistra  
Peso, kg 48

**60711 LAVELLO ARNO 120 DESTRO** DOL Art. 4294

**60712 LAVELLO ARNO 120 SINISTRO** DOL Art. 4295

**60771 LAVELLO ARNO T/FR SINISTRO** DOL Art. 4295

**60772 LAVELLO ARNO T/FR DESTRO** DOL Art. 4294

  
**ceramica dolomite**

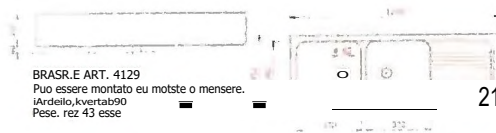
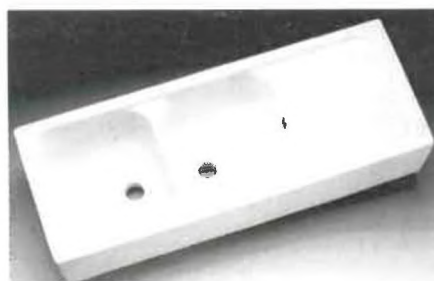

BRASILE ART. 4129  
Può essere montato su mobile o mensola.  
Peso: 43 kg

21

ree 099949 monte; su estbre r90,909e..140dint reversible  
fet-0 4889t4.

**60719 LAVELLO BRASILE 120**

DOL Art. 4326



PANAMA ART. 444614447/4448  
Adatto all'installazione su mobile. Modello reversibile.  
Peso: (Mod. 4441 kg. 36 circa) (Mod. 4447 kg 31 circa) (Mod. 4448 89. 28 arca).

**60724 LAVELLO PANAMA 100X45** DOLArt. 4446

**60725 LAVELLO PANAMA 90X45** DOLArt. 4447

**60726 LAVELLO PANAMA 80X45** DOLArt. 4448

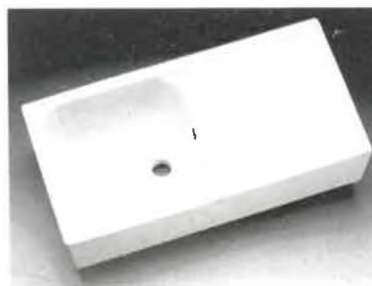

CANADA ART. 4842:444314844  
Adatto all'installazione CA mensola. Modello reversibile  
Peso: t Mod. 4642 kg. 33) Mod. 4643 kg. 32) 0404. 4644 kg.

**60736 LAVELLO CANADA 100** DOLArt. 4642

**60737 LAVELLO CANADA 90** DOLArt. 4643

**60738 LAVELLO CANADA 80** DOLArt. 4644



~MA ART. 403fr'l  
Metro di Inatazzwa 10.11 ~,49  
PaW Fic Norm.

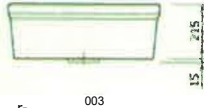

**60753 LAVELLO VIRGINIA 60**

DOLArt. 4667



PERSIA ART. 4671  
Adatto ah installazione si mensole.  
Peso kg 25 rea.

**60755 LAVELLO PERSIA 42**

DOLArt. 4671



MESSICO ART, 4877/4678  
V0600 lavaioic.  
33cedo pur essere nstailato  
5. mut 2;  
eso (mod. 4677 kg. 53  
mrd. 467 kg 42

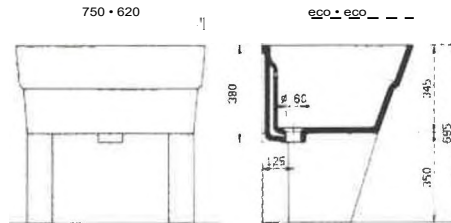
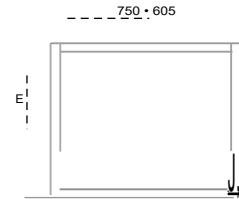

**60757 LAVATOIO MESSICO 75**

DOLArt. 4679

**60758 LAVATOIO MESSICO DUE 60**

DOLArt. 4680

**60759 COP. PIEDINI x MESSICO DUE**

DOLArt. J0847



PERU ART 415814767  
Q,MA MA-1553 \*Ontazono  
Iror, 4 7 47

**60760 LAVATOIO PERU 61x61**

DOL Art. 4766

**60761 LAVATOIO PERU 60x46**

DOLArt. 4767

ceramica dolomite

ceramica dolomitic

**Ceramica Dolomite Fireclay  
Piatti Doccia**

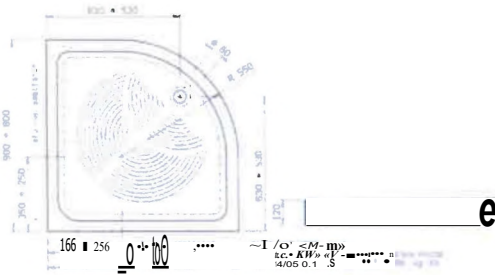
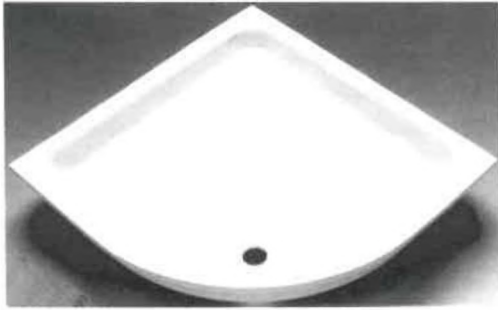

**60779 PIATTO SURF ANGOLO 90 BIAN** DOLArt. 4695

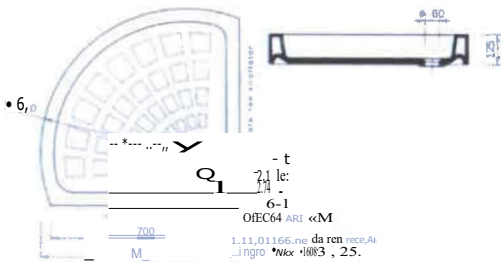
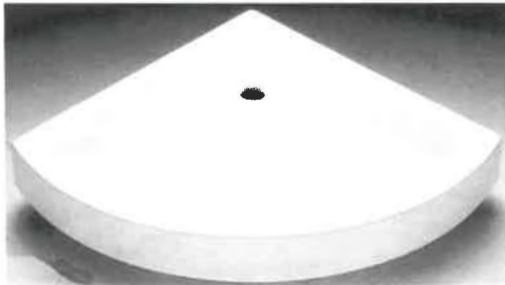

**60795 PIATTO GRECIA 80 ANG. BIAN** DOLArt. 4689

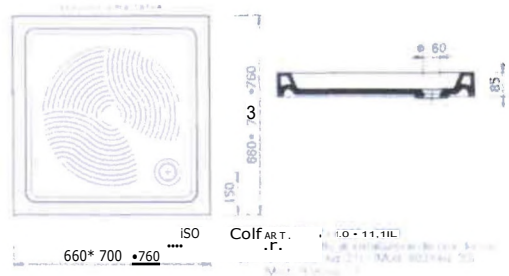
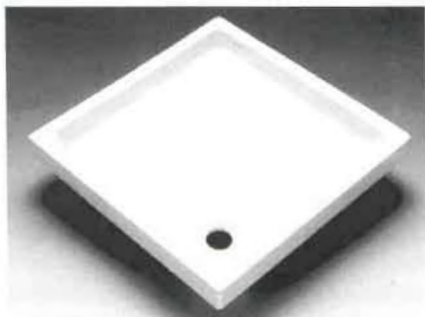

**60790 PIATTO GOLF 66 BIAN**

DOLArt. 4697

**60791 PIATTO GOLF 76 BIAN**

DOLArt. 4696

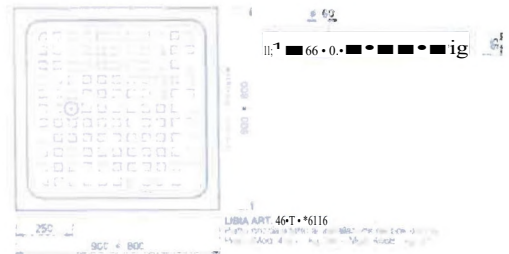

**60792 PIATTO LIBIA 80 BIAN**

DOLArt. 4688

**60793 PIATTO LIBIA 90 BIAN**

DOLArt. 4687

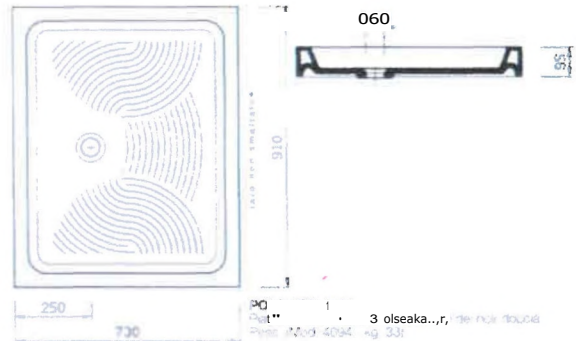
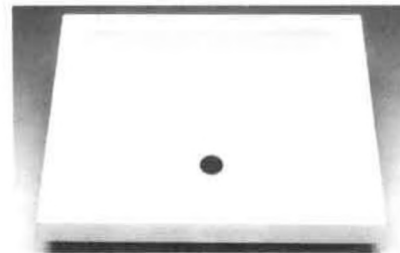

**60794 PIATTO POLO 73x91 BIAN**

DOLArt, assa

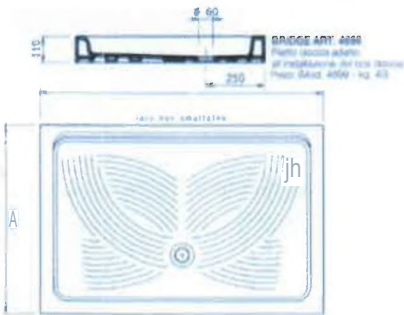

**60796 PIATTO BRIDGE 120x80 BIAN** DOLArt 4699

**Ceramica Ceseme Sanitari Serie Sintesi**



**62502 LAVABO 69 SIVTESI BIAN** csm Art. 76170

**62503 COLONNA SINTESI BIAN** csm Art. 76470

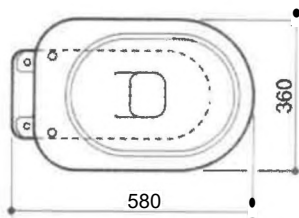

**62504 VASO SINTESI BIAN** CSM Art. 76200

**62505 VASO PARETE SINTESI BIAN** csm Art. 76202

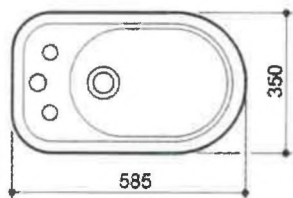

**62507 BIDET 1F SINTESI BIAN** CSM Art. 76355

**Ceramica Ceseme Sanitari Serie Aretuse**

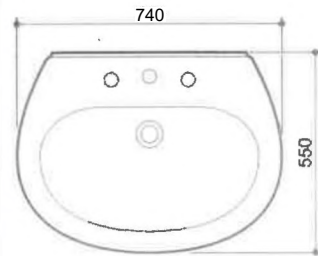

**62512 LAVABO ARETUSA BIAN** csm Art. 72170

**62513 COLONNA ARETUSA BIAN** csm Art. 72470

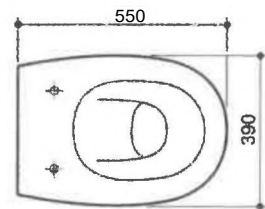

**62514 VASO ARETUSA BIAN** CSM Art. 72200

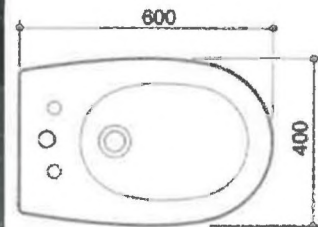

**62518 BIDET 1F ARETUSA BIAN** CSM Art. 72355

**62535 BIDET 3F ARETUSA BIAN** csm Art. 72350

**Ceramica Ceseme Sanitari Serie Belle Epoque**

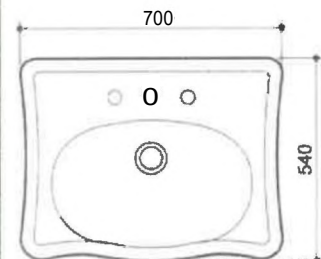

**62521 LAVABO B EPOQUE BIAN** CSM Art. 81170

**62522 COLONNA x LAVABO 32x32** CSM Art. 081470

**-CCS4/14C-**



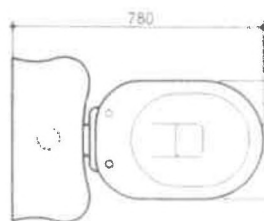

**62524** VASO B EPOQUE S/PARETE BIA CSM Art. 81201

**62525** CASSETTA B EPOQUE BIAN csro Art. 81502

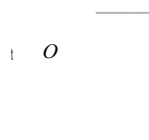

**62527** BIDET 3F B EPOQUE BIAN CSM Art. 81350

**Ceramica Pozzi Glnori  
Serie Selva**



**POZZI-GINDRI**

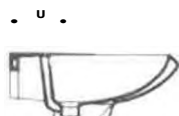

110

LI

DESCRIZIONE	A	B	C	O	41	PESO	O9
LAVABO	650	530	220	1	95	850	7,5
LAVABO	610	505	195	1	95	845	6,0
COLONNA ,PER 25031 -25042							10,0

**62900** LAVABO 65 SELVANOVA BIAN P-G Art. 25031

**62901** LAVABO 60 SELVANOVA BIAN P-G Art. 25042

**62903** COLONNA SELVANOVA BIAN P-G Art. 25151



UI 51 RIZIONE

PESO

VASO A SCARICO PAVIMENTO (EL105) 14.0

111/4 IDN 91

**62904** VASO PAVIM SELVANOVA BIAN P-G Art. 25301



.A0

Z40

045

DESCRIZIONE	PESO	9(6 c 4 I
BIDET A TRE FORI	1	5,0
BIDET MONOFORO	1	5,0

**62907** BIDET 3F SELVANOVA BIAN P-G Art. 25202

**62908** BIDET 1F SELVANOVA BIAN P-G Art. 25252



Sluna finlandese che per le sue dimensioni e per l'assorbimento contenuto, è particolarmente adatta all'inserimento in appartamenti. Può trovare collocazione sia in ambienti eleganti, sia in bagno o in piccole palestre. Curata in tutti i particolari, garantisce il massimo comfort e risolve tutti i problemi di spazio e di installazione. Le due panche, una scorrevole e una ribaltabile, permettono a due persone la posizione semisdraiata. Disponibile con ingresso frontale o angolare.

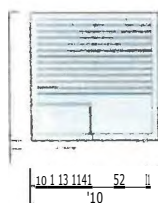

mod. F 120  
cm 120 x 120 x 190h  
Kw 2,0  
220 V mon. Ising. ph.



**61903 SAUNA MODELLO F 120** FGBArt. SAU120

**Ceramica Dolomite Sedili**



AMI

Lunghezza fondo: 444 mm  
Larghezza fondo: 365 mm  
Interasse cerniera: 165 mm  
Con cerniere cromate

**60607 SEDILE ALPINA QUADR. BIAN** DOL Art. 9141 P/C.5



Lunghezza fondo: 426 mm  
Larghezza fondo: 369 mm  
interasse cerniera: 165 mm  
Con cerniere cromate

**60608 SEDILE CORALLO** BIAN DoL Art. 9153 P/C.5



Lunghezza fondo: 430 mm  
Larghezza fondo: 363 mm  
Interasse cerniera: 160 mm  
Con cerniere cromate

**60609 SEDILE RIO** BIAN DOL Art. 9121 P/C.5



**60610 SEDILE ZAGARA** BIAN DOL Art. 9132 P/C.5

**60613 SEDILE x MONOBL. ZAGAR BIAN poi** Art. 9133 P/C.5



Lunghezza fondo: 411 mm  
Larghezza fondo: 338 mm  
Interasse cerniera: 155 mm  
Con cerniere cromate

**60611 SEDILE CLODIA** BIAN DOL Art. 9184 P/C.5



Lunghezza fondo: 413 mm  
Larghezza fondo: 365 mm  
Interasse cerniera: 155 mm  
Con cerniere cromate

**60615 SEDILE GARDA** BIANCO DoL Art. 9159 P/C.5



**ceramica dolomite**



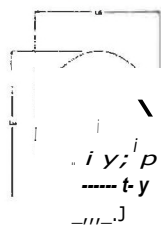

**Lunghezza fondo: 411 mm**  
**Larghezza fondo: 338 mm**  
**interasse cerniera: 155 mm**  
**Con cerniere cromate**

**60616 SEDILE PETRA** BIAN DOL Art. 9149 P/C.5

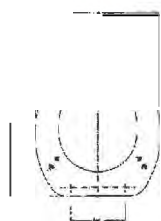

**Lunghezza fondo: 440 mm**  
**Larghezza fondo: 375 mm**  
**Interasse cerniera: 150 mm**  
**Con cerniere cromate**

**60617 SEDILE PERLA** BIAN DOL Art. 9181 P/C.5

**Ceramica Dolomite Accessori Per Sedili**



**60618 PARACOLPI SED. CLODIA-FLEO** DOL Art. 9006 P/C.1

**60619 PARACOLPI SED. ALPIN/QUADR** DoL P/C.1

**60620 PARACOLPI SEDILE RIO** DOL P/C.1

**60645 CERN x SED RIO/CLOD CR COP** DOL Art. 9400c P/C.1

**60646 CERN X SED QUAD/ALP CR COP** DOL Art. 9401c P/C.1

**Ceramica Cesame Sedili**



**62509 SEDILE SINTESI BIAN** csm Art. 99074 P/C.5



**62528 SEDILE B EPOQUE BIAN** csm Art. 99049 P/C.5

**Sedili per Serie Ceramica Ideai Standard**



**64320 SEDILE ESEDRA** BIAN IDE Art. T627400 P/C.5



**64321 SEDILE FIORILE** BIAN IDE Art. T628700 P/C.5



**64330 SEDILE CONCA AI VOLG. BIAN** IDE Art. T623300 P/C.5

Lunghezza fondo cm 43,3  
Larghezza fondo cm 34,6  
Interasse Cernern Cm 16



→à

- 64331** *SEDILE CONCA* **BIANCO** IDE Art. T618200 P/C.5
- 64401** *SEDILE CONCA CHAMPAGNE* IDE Art. T618210 P/C.5
- 64601** *SEDILE CONCA* **BIAN** FRG Art. F/20 CA P/C.5
- 64630** *SEDILE CONCA* **CHAM** FRG Art. F 20 P/C.5
- 64421** *SEDILE CONCA* **VISO** FRG Art. F/20 CA P/C.5
- 64510** *SEDILE CONCA POLIDUR BIANC* **C.M** Art. 340070002

Lunghezza fondo cm 43,4  
Larghezza fondo cm 34,1  
Interasse (crucci) cm



- 64332** *SEDILE ELISSE* **BIANCO** IDE Art. T606300 P/C.5
- 64403** *SEDILE ELISSE. CHAMPAGNE* IDE Art. T606310 P/C.5
- 64603** *SEDILE ELISSE-SELVA BIAN* FRG Art. F/21 CA P/C.5
- 64621** *SEDILE ELISSE* **CHAM** FRG Art. F/21 CA P/C.5

Lunghezza fondo cm 43,5  
Larghezza fondo cm 34,9  
Interasse cerniera cm 16



- 64333** *SEDILE LINDA* **BIANCO** IDE Art. T604500 P/C.5
- 64402** *SEDILE LINDA CHAMPAGNE* IDE Art. T604510 P/C.5
- 64602** *SEDILE LINDA* **BIAA** FRG Art. F/8 L P/C.5

4w'

trng n71 fonde. cm 45,5  
hiZe (1WD) cm 34,9  
cm 16



- 64334** *SEDILE LIUTO* **BIANCO** IDE Art. 7628200 P/C.5
- 64406** *SEDILE LIUTO CHAMPAGNE* IDE Ari T626210 P/C.5

Ni Lunghezza fondo cm 39,6  
Larghezza fondo cm 35,4  
Interasse cerniera cm 16



- 64337** *SEDILE AERO* **BIANCO** IDE Art. T613000 P/C.5



Lunghezza fondo cm 41,3  
Larghezza fondo cm 36,5  
Interasse cerniera cm 16

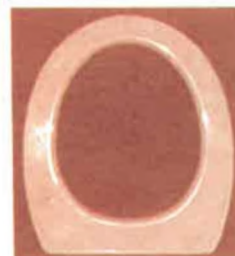

- 64338** *SEDILE ALA* **BIANCO** IDE Art. T620900 P/C.5
- 64408** *SEDILE ALA CHAMPAGNE* IDE Art. T620910 P/C.5



Lunghezza fondo 42,3  
Larghezza fondo cm 34  
Interasse cerniera 16



- 64339** *SEDILE TESI* **BIANCO** IDE Art. T611600 P/C.5
- 64623** *SEDILE TESI* **CHAM** FRG Art. F/40 P/C.5
- 64604** *SEDILE TESI* **BIAN** FRG Art. F/40 CA P/C.5
- 64512** *SEDILE TESI POLIDUR BIANCO* C-M Art. 340060002



**64340** *SEDILE SMALL* **BIAN** IDE Art. T607600 P/C.5

**Sedili Friges Per Serie Ideai Standard**



Lunghezza fondo **cm 45,3**  
 Larghezza fondo **cm 37,5**  
 Interasse cerniera **cm 13,5**  
 Tipo cerniera **CR E**  
 Lavorazione **colato**



- 64600** *SEDILE UNIVERSALE* **BIAN** FRGArt. F/5 CA P/C.5
- 64620** *SEDILE UNIVERSALE* **CHAM** FRGArt. F/5 CA P/C.5
- 64640** *SEDILE UNIVERSALE* **VISO** FRGArt. F/5 CA P/C.5
- 64670** *SEDILE UNIVERSALE* **ROVE** FRGArt. F/5 L P/C.5
- 64671** *SEDILE UNIVERSALE* **NOCE** FRGArt. F/5 L P/C.5

Lunghezza fondo **cm 44,3**  
 Larghezza fondo **cm 34,9**  
 Interasse cerniera **cm 16**  
 Tipo cerniera **CR H**  
 Lavorazione **colato**

**64606** *SEDILE VELARA* **BIAN** FRGArt. F/36 P/C.5



Lunghezza fondo **cm 45,1**  
 Larghezza fondo **cm 33,7**  
 Interasse cerniera (mieta) **cm 19**  
 Tipo Cerniera **CR H**  
 Lavorazione **colato**



**64608** *SEDILE SINTESI BIAN* FRGArt. F/28 P/C.5

**Sedili Per Serie Ceramica Dolomite**



Lunghezza fondo **cm 44,4**  
 larghezza fondo **cm 36,5**  
 Interasse cerniera **cm 16,5**  
 Tipo cerniera **CR Q**  
 Lavorazione **colato**

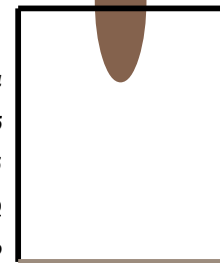

- 64591** *SEDILE ALPIN-QUADRAR.* **CHAM** FRG Art. F/61 P/C.5
- 64610** *SEDILE ALPINA-QUADRAR BIAN* FRG Art. F/61 P/C.5
- 64410** *SEDILE ALPINA* **CHAM** DOL Art. 9141 P/C.5



Lunghezza fondo **cm 43,1**  
 Larghezza fondo **cm 35,9**  
 Interasse cerniera **cm 15**  
 Tipo cerniera **CR C**  
 Lavorazione **colato**



- 64616** *SEDILE SQUARE* **BIAN** FRGArt. F/10 BIS CA P/C.5
- 64593** *SEDILE SQUARE* **CHAMP** FRGArt. F/10 BIS P/C.5

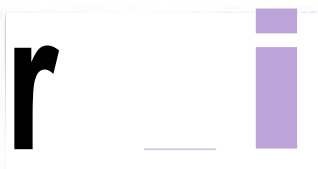

Lunghezza fondo **cm 43**  
 Larghezza fondo **cm 36,3**  
 Interesse cerniera **cm 16**  
 Tipo cerniera **CR O**  
 Lavorazione **celato**



**64612** *SEDILE RIO* **BIAN** FRG P/C.5

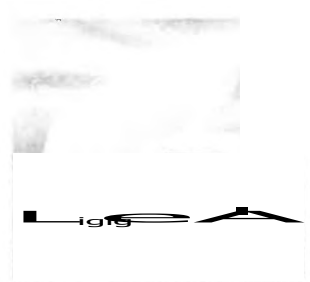

**64615** *SEDILE PIEMONTE BIAN* FRGArt. F/31 CA P/C.5



Lunghezza fondo **cm 49,9**  
 Larghezza fondo **cm 36,3**  
 Interesse cerniera **cm 15**  
 Tipo cerniera **CR C**  
 Lavorazione **colate**



**64617** *SEDILE ITALICA* **BIAN** FRGArt. F/9 CA P/C.5  
**64619** *SEDILE ITALICA CHAMPAGNE* FRGArt. F/9 CA P/C.5

**Accessori Per Sedili**



- 64354** *COPPIA CERN.SED.LINDA-TESEI* IDE Art. 0231256 P/C.1
- 64355** *COPPLA CERN.SED.CONCA* IDE Art. 0231260 P/C.1
- 64356** *COPPIA CERNSED.ELLISSE* IDE Art. 0231262 P/C.1
- 64357** *COPPLA CERNSED.LILITO* IDE Art. 0231263 P/C.1



**Per tutti i sedili ECCEPPO  
 "Conca Avvolgente"**

- 64358** *PARACOLPI x SLDILI IDEAL* IDE Art. 0604014 P/C.1
- 64359** *PARACOLPI x SED.AERO/CALLA* IDE Art. 604006 P/C.1



**64699** *PARACOLPI SEDILE CONCA SP.* FRGArt. 320032 P/C.1



**64700** *PARACOLPI TONDO H 7.5 mm* FRGArt. 320030 P/C.1



**64703** *PARACOLPI TONDO H 10 mm* FRGArt. 320037 P/C.1  
**64698** *GOMMINI x SEDILE* FRG P/C.1



**64702** *PARACOLPI 2 CHIODI H 10 mm* FRGArt. 320031 P/C.1  
**64701** *PARACOLPI 2 CHIODI H 12 mm* FRGArt. 320042 P/C.1



**64706** *PARACOLPI 2 INNESTI 10 mm* FRGArt. 320034 P/C.1



**64690** *COPPIA CERIVIERE x COMP* FRGArt. TIPO F PIC.1



**64704** *COPPIA CERMERE X SED F9* FRGArt. TIPO C CROM P/C.1  
**64705** *COPPIA CERNIERE X CONCA* FRGArt. TIPO A CROM P/C.1

**Sedili Universali**

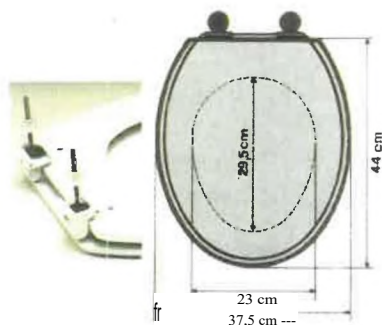

- 64605 SEDILE NUOVO JOLLY BIAN FRG P/C.6
- 64694 COPPIA CERN. NUOVO JOLLY FRG P/C.1
- 64695 SOLO VITI FISSAGG. JOLLY FRG P/C.1



**Sedile per comunità MAMO**  
 Con molla per il sollevamento automatico del sedile.  
 Dotato di piastra posteriore per rendere i fori adattabili ad ogni genere di vaso  
 Colore: BIANCO

- 64672 SEDILE MAMO APERTURA MOLLA M-L Art. 960.MOLLA



**SEDILE UNIVERSALE**  
 PACCHI DA 12 PEZZI.

- 63506 SEDILE MIKI BIANCO DIN P/C.10
- 63507 SEDILE MIKI NERO DIN P/C.10
- 63508 CERNIERE x SED MIKI COPPIA DIN P/C.1

**Sedili In Plastica Carrara E Matta**



*Per vaso Ellisse*

- 64502 SEDILE RICCIONE BIAN C-M Art 100243002 P/C.5

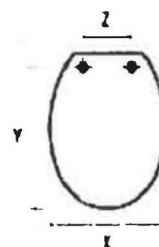

x: 37,3  
 y: 42,9-48,2  
 z: 13,9-15,9  
**peso: KG 2,90**

- 64503 SEDILE ATLANTICO I C BIAN C-M Art. 100315002 P/C.5
- 64504 SEDILE ATLANTICO I C NERO C-M Art. 100315001 P/C.5

**Accessori Per Sedili Plastica Carrara E Matta**



- 64518 KIT CERNIERE ATLANTICO C-M Art. 104805000 P/C.12



- 64524 KIT PARACOLPI ATLANT BIAN C-M Art. 104865002 P/C.12
- 64525 KITPARACOLPIATLANT NERO C4A Art. 104865001 P/C.12

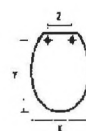

x: 37  
 y: 42-44  
 z: 14,5-16,5  
**peso: KG 1**

- 64513 SEDILE SEDILO BIAN C-M Art. 108031002 P/C.5



- 64520 KIT CERNIERE S 12 C-M Art. 104802000 P/C.12



- 64522 KIT PARACOLPI S 12 BIAN C-M Art. 104861002 P/C.12
- 64523 KIT PARACOLPI S 12 NERO C-M Art. 104861001 P/C.12

**Apparecchi Sanitrit Sfa Per Evacuazione Scarichi**



**SFA**

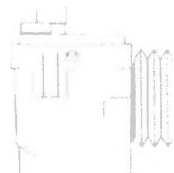

WL  
 tutti 5 27/7S  
 tira a 0 me tr 32/40 m-i

°aC: ".orrir.  
 x m ri

**62806 SANITRIT WC**

SFA Art. 511010



**62800 SANITOP WC**

SFA Art. 511020



mm

**62803 SANIPLUS WC**

SFA Art. 511030

**SIFA**



ai

bagno completa + lavatrice  
 fino a 7 m - tubi Ø 22/28 mm  
 fino a 100 m - tubi Ø 32/43 mm  
 90°13 (per breve tempa)  
 230 V / 59 Hz  
 620 W  
 529 a172a270,5mm  
 sistema anti-ritorno esterno  
 accessori di raccordo in bianco  
 filtra a carboni attivi anti-odore  
 rumorosità 57 db

62810 SANIBEST 2

SFA



Mount di 4 entrate  
 per pompa

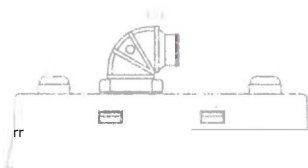

111  
 E3



lavatrice, lavastoviglie, vasca,  
 doccia, lavabi, bidet  
 fino a 5 m - tubi Ø 32 mm  
 fino a 50 m - tubi Ø 32/40 mm  
 90°C (per breve tempo)  
 230 V / 50 Hz  
 350 W  
 373 x 185 x 255,9 mm  
 sistema anti-ritorno esterno  
 accessori di raccordo in bianco  
 rumorosità 44 db

62808 SANIVITE 3

SFA Art. 511040

### Sanitari Per Disabili-Vasi-

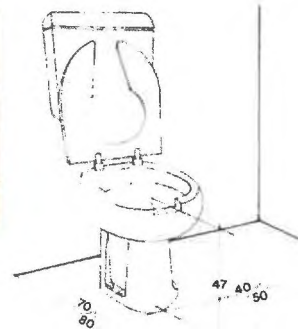

Distanza dalla parete  
 al centro del foro: 25 cm  
 o foro: 27 cm

**Realizzato in vitreous china bianco, materiale forte e resistente non solo a sforzi e pressioni, ma anche alle aggressioni di detersivi acidi ed abrasivi, spesso utilizzati per igienizzazione dei sanitari. SANIWAT M è realizzato in ottemperanza alla normativa vigente DPR 503/96**

62720 SANIWAT SCARICO TERRA B.00 SNT Art. 03WC00



Distanza dalla parete  
 al centro del foro: 25 cm  
 o foro: 27 cm

46 4015°

**Realizzato in vitreous china, garantisce una incredibile resistenza agli acidi, agli abrasivi, a carichi e pressioni. Ideato specificamente per soddisfare le esigenze di utenti anziani o portatori di handicap, offrendo loro un servizio pratico, igienico ed assolutamente sicuro. Doppia funzione di vaso-bidet. Le acque di scarico e quelle dei lavaggio hanno immissioni, percorsi e fuoriuscite separati ed indipendenti.**

62722 WC-BIDET SANITHAND SC/PAV SNT Art. 12WC07B P/C.



Distanza dalla parete  
al centro del foro: 25 cm  
o foro: 27 cm



Realizzato in vitreous china, garantisce una incredibile resistenza agli acidi, agli abrasivi, a carichi e pressioni. Ideato specificamente per soddisfare le esigenze di utenti anziani o portatori di handicap, offrendo loro un servizio pratico, igienico ed assolutamente sicuro. Doppia funzione di vaso-bidet. Le acque di scarico e quelle del lavaggio hanno immissioni, percorsi e fuoriuscite separati ed indipendenti.

62723 WC-BIDET SANITHAND SC/PAR strart. 12WCB08B

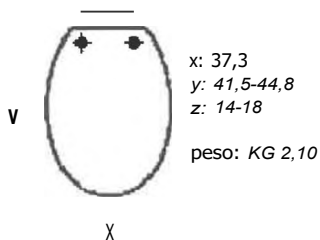

62721 SEDILE KELA POLIEST.BIANCO SNTArt. 04KELOO P/C.10

62741 CERNIERA x SED DISAB CROM SNTArt. 04CER01 P/C.1

Sanitari Per Disabili-Lavabi-

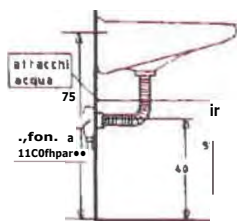

SEMIFONTE è uno epicisde lavabo fisso realizzato in ceramica bianca, ideato e costruito per incontrare le esigenze di utenti anziani o portatori di handicap. Per la aua forma ed li materiale con il quale è realizzato, naturalmente in ottemperanza alla normativa vigente (DPR 503196), SEMIFONTE è Ideale per locali pubblici, residenze artelatite, carte di cure e complessi ospedalieri, ma anche per edifici privati.

62739 LAVABO SEMIFONTE 64 cm SNT Art. 03LAV00

KIT SCARICO C  
Kit completo di  
piletta grigliata,  
tubo estensibile e  
sifone da esterno

62740 KIT SCARICO C x LAVABO SNTArt. 12KITC

Ausili Per Disabill  
Menlglioni 0 32 Colore Bianco



Accessori per la  
sicurezza in bagno

MANIGLIONE CORRIMANO

Misure: 30/45/60/90/120 cm

62600 MANIGLIONE ORIZZ. 30 cm THEArt. M30 P/C.1

62601 MANIGLIONE ORIZZ. 45 cm THEArt. M45 P/C.1

62602 MANIGLIONE ORIZZ 60 cm THEArt. M60 P/C.1

62603 MANIGLIONE ORIZZ 90 cm THEArt. M90 P/C.1

62604 MANIGLIONE ORIZZ. 120 cm THEArt. M120-B P/C.1

id t regit"



Accessori per la  
sicurezza in bagno

CORRIMANO AD ANGOLO

Misure: 67 x 67 cm

62605 CORRIMANO ANG. x DOCCIA THEArt. 120 P/C.1

ting.~-M11<sup>3</sup>

Accessori per la  
sicurezza in bagno

CURVA PROTEZIONE SIFONI

PER LAVABI DI TIPO A MENSOLA

Colore: bianco

62628 CURDA PROTEZIONE SIFONE THEArt. 340 P/C.1





**Accessori per la  
sicurezza in bagno**  
**MANIGLIONE ANGOLARE  
CON MONTANTE**

Disponibile con montante a destra  
o a sinistra,  
**Misure: 350 x 670 mm**

- |   |             |       |
|---|-------------|-------|
| <b>62607</b> MANIGLIONEANG. 21/MONT. DES. | THEArt. MAD | P/C.1 |
| <b>62608</b> MANIGLIONEANG. MONT. SIN.    | THEArt. MAS | P/C.1 |



**Accessori per la  
sicurezza in bagno** **C:A.**  
**BARRA DI SOSTEGNO  
RIBALTABILE**

Dotata di dispositivo di  
bloccaggio in posizione verticale  
Lunghezza: 60/83 cm  
Colore: bianco

- |                                      |             |       |
|--------------------------------------|-------------|-------|
| <b>62611</b> BARRA RIBALTABILE 60 cm | THEArt. 600 | P/C.1 |
| <b>62612</b> BARRA RIBALTABILE 83 cm | THEArt. 830 | P/C.1 |



**Accessori per la  
sicurezza in bagno** **e>.**  
**BARRA DI SOSTEGNO  
RIBALTABILE**

Dotata di dispositivo di  
bloccaggio in posizione verticale  
e di porta carta igienica.  
Lunghezza: 83 cm  
Colore: bianco

- |   |               |       |
|---|---------------|-------|
| <b>62617</b> BARRA RIBALT CIPORT cm83 B | THEArt. 840-B | P/C.1 |
|---|---------------|-------|



**Accessori per la  
sicurezza in bagno** **(,,,'.**

**BARRA DI SOSTEGNO  
RINFORZATA**

Disponibile con montante a destra  
o a sinistra.

**Misure:** 60 cm con rinforzo a destra  
60 cm con rinforzo a sinistra  
83 cm con rinforzo a destra  
83 cm con rinforzo a sinistra

- |   |             |       |
|---|-------------|-------|
| <b>62613</b> BARRA FISSA RINF DES 60 cm | THEArt. 601 | P/C.1 |
| <b>62614</b> BARRA FISSA RINF SIN 60 cm | THEArt. 602 | P/C.1 |
| <b>62615</b> BARRA FISSA RINF DES 83 cm | THEArt. 831 | P/C.1 |
| <b>62616</b> BARRA FISSA RINF SIN 83 cm | THEArt. 832 | P/C.1 |

# ihrailL3

**Accessori per la  
sicurezza in bagno**

**SEDILE RIBALTABILE  
PER DOCCIA**

Ingombro: L 33 x P 44 x H 50  
Colore: bianco

- |  |             |       |
|--|-------------|-------|
| <b>62621</b> SEDILE RIBALTAB. x DOCCIA | THEArt. SRD | P/C.1 |
|--|-------------|-------|



**Accessori per la  
sicurezza in bagno**

**SEDILE RIBALTABILE CON  
BRACCIOLI PER DOCCIA**

- |  |             |       |
|--|-------------|-------|
| <b>62622</b> SEDILE RIB C/BRACx DOCCIA | THEArt. SSB | P/C.1 |
|--|-------------|-------|

V



62623 SEDILE x VASCA 70 cm

THEArt. SV

P/C.1



Accessori per la  
sicurezza in bagno **O.**

### SPECCHIO AD INCLINAZIONE REGOLABILE

Misure: 60 x 50 cm  
Colore: bianco

62626 SPECCHIO INCLINABILE 60x50 THEArt. 350-N

P/C.1

EN

Accessori per la  
sicurezza in bagno 

PORTA  
CARTA IGIENICA  
Colore: bianco

62627 PORTA CARTA IGENICA RINE.

THEArt. 360

P/C.1



11

Accessori per la  
sicurezza in bagno

### CORRIMANO VERTICALE PARETE-PAVIMENTO

Altezza: 180 cm  
Colore: bianco

62630 CORRIMANO VERTICALE 180 cm THEArt. 330

P/C.1

62631 CORRIMANO VERTICALE 180 cm THEArt. 330-1

P/C.1

Accessori In Acciaio Inox  
Bobrich Antivandalici

### INOX C/CHIAVE MADE IN USA



**18-262 SURFACE-MOUNTED PAPER TOWEL DISPENSER** Dispenses 400 C-fold or 525 multifold towels without adjustment or adapters. Cabinet type-304 stainless steel, satin finish. Door has tumbler lock and piano-hinge. Cabinet slots indicate refill time. 10W wide, 143/4" high, 4" deep (273 x 375 x 102mm).

62745 DISTRIBUTORE ASCIUG CARTA OND

Art. B 262 P/C.1



**fB-288 SURFACE-MOUNTED MULTISOLL TOILET TISSUE DISPENSER** Holds two standard-core toilet tissue rolls up to (133mm) diameter (1800 sheets). Extra roll automatically drops in place when bottom roll is depleted. Theft-resistant, heavy-duty, one-piece molded polyethylene spindles have 5e (8mm) wall thickness. Measures 6Me wide, 11" high, 5" x 6" deep (155 x 280 x 150mm).

62751 PORTA ROTOLO DOPPIO

OND

Art. B 288 P/C.1

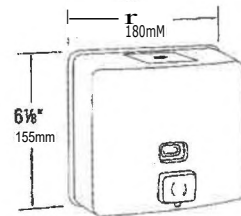

62755 DISTRIBUTORE SAPONE LIQUID

OND

Art. 64112 Pic.i

### Accessori Bagni Pubblici Elettronici



Asciugamani a fotocellula.

62700 ASCIUGAMANI ELET TORNADO B

DMP Art. 03103 P/C.1



Dosatore a, fotocellula.

62702 DOSASAPONE

QUICK

DMP Art. 042

P/C.1

## Asciugacapelli Albergo A Prelievo Bocchettone



- Alimentazione elettrica (IMQ) (220 V • 50 Hz oppure 120 V 60 Hz)
- Cronometro e spegnimento automatico, con il corvo, il timer.
- Dispositivo di spegnimento alla caduta veriviva del rubo flessibile e modelli 'ilati Xt P/
- Convolto a ore and c: nrtidn (un camera lemma in mscotratura
- TISSAgllo di parete con sistema di scompar „I
- Tubo flessibile neofredto intermonertte c ori mOllii In il4(idi0 'noir ricoperto
- SeVed esterna m ABS, parti interne nr nylon fibra vetro
- Timer di spegnimento automatico dopo l m m d, h:p/modi/lento continuo (monelli fli
- Possibilità per prese i ncti 020/120 ' / moti 10 via con tratitorinatore di sicure:7a • rtnit otettore interno i) pteniVr 00 • orbita• 800W circa Kg



72211 ASCIUGACAP PICK-UP AUT BIA DMP Art. 03403 P/C.1

### Accessori Di Completamento Per Bagni Pubblici



**DISTRIBUTORE ASCIUGAMANI per 250 fogli circa.**  
**Dim. (L x p x a):**  
 300 x 100 x 290 mm

62820 DISTRIBUTORE ASCIUGAMANI GSG Art. 535 P/C.1

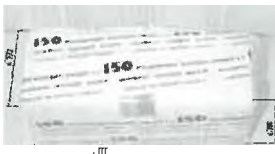

**CARTA ASCIUGAMANI**  
**Confezione da 160 fogli.**  
**Imballo:** 20 confezioni

62844 ASCIUGAM 160 F.x DIST. 535 GSG Art. 72.122CELTE P/C.150

4111MIZor

**PORTAROTOLO PER CARTA IGIENICA**  
**Formato MEDIO**  
**In plastica (con portaceneri metallico)**  
**o: 260 mm (per rotoli da i kg. Circa)**  
**Prof.: 130 mm**

62823 PORTAROTOLO CARTA IGIENICA GSG Art. 511 P/C.1



**ROTOLO CARTA IGIENICA**  
**Peso:** 0,8 kg  
**Rotolo da 160 mt.**  
**Imballo:** 12 rotoli

62853 ROTIGIENICA MINIJUMBOCELLGSG Alt 20.160CELTE P/C.1



**PORTAROTOLO PER CARTA IGIENICA**  
**Formato MEDIO**  
**Realizzato in acciaio INOX**  
**o: 290 mm (per rotoli o 270 mm)**  
**Prof.: 130 mm**

62822 PORTAROT CARTA IGIEN INOX GSG Art. 673 INOX



**DISTRIBUTORE DI SAPONE LIQUIDO**  
**In acciaio INOX**  
**Capacità:** 1,2 lt  
**Dim. (L x p x a):**  
 110 x 105 x 320 mm

62821 DISTRIB SAP LIO LI1.2 INOX GSG Art. 542 INOX



**DISTRIBUTORE DI SAPONE LIQUIDO**  
**Cromato**  
**Capacità:** 1,2 lt  
**Dim. (L x p x a):**  
 140 X 120 x 215 mm

62826 DISTRIBUTORE SAP LIQ L 1.2 GSG Art. 501 P/C.1



*Movellini*

**Ad Angolo Da Assemblare**

Anzicare a dir l'ante scorrevoli,  
ersibile i cm 185



l. Al I standard

e 70

cm. 66 ↔ 72

• 75

cm. 72 ↔ 78

• 80

cm. 78 ↔ 84

• 90

cm. 84 ↔ 90

• **Comporre un angolo completo  
ordinando due lati.**

**Box: Bianco  
RAL 9010**



**Lastra  
in metacrilato**

- 69705 STAR LAT A70 66/72 AN/9010 NOV Art. STANL070AB P/C.**
- 69706 STAR LAT A75 72/78 AN/9010 NOV Art. STANL075AB P/C.**
- 69707 STAR LAT A80 78/84 AN/9010 NOV Art. STANL080AB P/C.**
- 69708 STAR LAT A90 84/90 AN/9010 NOV M. STANL090AB P/C.**

**Box: Bianco  
RAL 9010**



**Lastra in  
Cristallo /l'amato**

- 69550 STAR LATO A 70 CR/PRI/BCO NOV Art. STAL070-052 P/C.**
- 69551 STAR LATO A 75 CR/PIU/BCO NOV Art. STAL075-052 P/C.**
- 69552 STAR LATO A 80 CR/PIU/BCO NOV Art. STAL080-052 P/C.**
- 69553 STAR LATO A 90 CR/I:TU/13GO NOV Art. STAL090-052 P/C.**

**Porta Del Box Con Tre Ante  
Scorrevoli Su Ambo I Lati  
IN METACRILATO**

Porta a tre ante scorrevoli  
l) m185

crystallo cristallo scilato  
trasparente opaco fumato ambrato  
see star/box



l)( )R1 E: standard

70

cm. 66 ↔ 72

75

cm. 72 → 78

80

cm. 78 ↔ 84

90

cm. 84 ↔ 90

97

cm. 90 → 96

100

cm. 96 → 102

**Box: Bianco  
RAL 9010**

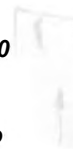

**Lastra  
in metacrilato**

- 69720 STAR 3ANT 70 66/72 AN/9010 NOV Art. STP70AB P/C.**
- 69721 STAR 3ANT 75 72/78 AN/9010 NOV Art. STP75AB P/C.**
- 69722 STAR 3ANT 80 78/84 AN/9010 NOV Art. STP80AB P/C.**
- 69723 STAR 3ANT 90 84/90 AN/9010 NOV Art. STP90AB P/C.**
- 69724 STAR 3ANT 95 90/96 AN/9010 NOV Art. STP95AB P/C.**
- 69725 STAR 3AN 100 96/ 102AN/9010 NOV Art. STP100AB P/C.**

*Movellini*

*Movellini*

**Porta Del Box Del Tipo A Soffietto**



Porta sottietth 1. ro-versibile  
 li (n1185

Pc )RTF standard

- 70  
cm. 66 ↔ 72
- 75  
cm. 72 ↔ 78
- 80  
cm. 78 ↔ 84
- 90

**Box: Bianco  
 RAI\_ 9010**

**Lastra  
 in metacrilato**

- 69737 STAR SOF 70 66/72 AN/9010 NOV Art. STS070AB P/C.
- 69738 STAR SOF 75 72/78 AN/9010 NOV Art. STS075AB P/C.
- 69739 STAR SOF 80 78/84 AN/9010 NOV Art. STS080AB P/C.
- 69740 STAR SOF 90 84/90 AN/9010 NOV Art. STS090AB P/C.
- 69741 STAR SOF 95 90/96 AN/9010 NOV Art. STS095AB P/C.
- 69742 STAR SOF100 96/102 AN/9010 NOV Art. STS100AB P/C.

**Box: Bianco  
 RAL 9010**

**Lastra in  
 Cristallo piumato**

- 69556 STAR SOF. 70 CR/PIU/BCO NOV Art. STS070-0526 P/C.
- 69557 STAR SOF. 75 CR/PIU/BCO NOV Art. STS075-0526 P/C.
- 69558 STAR SOF. 80 CR/PIU/BCO NOV Art. STS080-0526 P/C.
- 69559 STAR SOF. 90 CR/PIU/BCO NOV Art. STS090-0526 P/C.



**Porta Del Box Del Tipo Due Soffietti  
 IN METACRILATO**



l) 15

**Box: Bianco  
 RAL 9010**

**Lastra  
 in metacrilato**

- 69747 STAR 2S 108 108/114 A/9010 NOV Art. S2S108AB P/C.
- 69748 STAR 2S 114 114/120 A/9010 NOV Art. S2S114AB P/C.

**Porta Del Box Del Tipo Due Battenti  
 IN METACRILATO**



Porta 3 it di cui una scorrevole  
 reversibile - h cm 195

PORI [ standard

- Eri
- i lo2
- I 2(1
- 14 «E- 3»

**Box: Bianco  
 RAL 9010**

**Lastra  
 in metacrilato**

- 69743 STAR 2 P 102/108 AC/ANE/B1 NOV Art. S2P105AB P/C.
- 69745 STAR 2P 120 114/120 A/AN/B NOV Art. S2P120AB P/C.



**Lato Fisso Del Box Da Assemblare Ai Vari Tipi DI Porta**



Parete fissa, reversibile - h cm 185  
(multi, al fili « L.  
trasparente sattrbpiumato anelleanti  
ser. Ntarlribt.  
%ti trtnatia

**PARE11 FISSE standard**

70  
cm. 66 •—e. 72

75  
cm. 72 78

.80  
cm. 78 -4—> 84

90  
cm. 84 90

**Box: Bianco  
RAL 9010**

**Lastra  
in metacrilato**

- |   |            |              |      |
|---|------------|--------------|------|
| <b>69731</b> STAR FISS 70 66/72 AN/9010 | <b>NOV</b> | Art. STF70A6 | P/C. |
| <b>69732</b> STAR FISS 75 72/78 AN/9010 | <b>NOV</b> | Art. STF75AB | PIC. |
| <b>69733</b> STAR FISS 80 78/84 AN/9010 | <b>NOV</b> | Art. STF80AB | P/C. |
| <b>69734</b> STAR FISS 90 84/90 AN/9010 | <b>NOV</b> | Art. STF90AB | P/C. |

**Box: Bianco  
RAL 9010**

**Lastra in  
Cristallo piumato**

- |                                      |            |                  |      |
|--------------------------------------|------------|------------------|------|
| <b>69564</b> STAR FIS. 70 CR/PIU/BCO | <b>NOV</b> | Art. STF070-0526 | P/C. |
| <b>69565</b> STAR FIS. 75 CR/PIU/BCO | <b>NOV</b> | Art. STF075-0526 | P/C. |
| <b>69566</b> STAR FIS. 80 CR/PIU/BCO | <b>NOV</b> | Art. STF080-0526 | P/C. |
| <b>69567</b> STAR FIS. 90 CR/PIU/BCO | <b>NOV</b> | Art. STF090-0526 | P/C. |

**Lato Del Box Semicircolare Da Assemblare**



**Box: Bianco  
RAL 9010**

**Lastra  
in metacrilato**

Box dor r la semicircolare  
h m 185

R 80  
rll, tt

R 90  
z58,r)\*R--e- 'il

**Piatti 90 x 90:**

- IDEAL STANDARD (1010)
- POZZI GINORI (NEVA)
- VILLEROY E BOCH (BAIKAL 9051)
- GALASSIA (VENUS MAX)
- SENESI (ONDA 2317)
- DOLOMITE (SURF)
- FLAMINIA 90 x 90
- ROCA (SHERRY)
- SIMAS (538)
- ARCADIA (GIOTTO)

**Piatti 80 x 80:**

- IDEAL STANDARD (1176)
- POZZI MORI (NEVA)
- VILLEROY E BOCH (BAIKAL 8052)
- GALASSIA (VENUS)
- SENESI (ONDA 2314)
- ROCA (SHERRY / MALTA)
- DOLOMITE (SURF)
- SIMAS (S37)
- ARCADIA (GIOTTO)

- |   |            |                |      |
|---|------------|----------------|------|
| <b>69775</b> STAR LATO DX R3 80 ACR/A/B | <b>NOV</b> | Art. STR8OLDAB | P/C. |
| <b>69776</b> STAR LATO SX R3 80 ACR/A/B | <b>NOV</b> | Art. STR8OLSAB | P/C. |
| <b>69773</b> STAR LATO DX RI 90 ACR/A/B | <b>NOV</b> | Art. STR9OLDAB | P/C. |
| <b>69774</b> STAR LATO SX RI 90 ACR/A/B | <b>NOV</b> | Art. STR9OLSAB | P/C. |

**Parete a tre pannelli per vasca**



**Box: Bianco  
RAL 9010**

**Lastra  
in metacrilato**

Parete piegho, ole per \ asc a a tre pannelli,  
reversibile -1.1(

40- ( • .R (H ( (

Il 111<xkilit1 l'ett4 re m e dispotil)ik  
nelle 1111 IHC sprs. MIL

- |   |            |               |      |
|---|------------|---------------|------|
| <b>69580</b> PETER 1-140x140 ACR/ANE/BI | <b>NOV</b> | Art. PRT138AB | P/C. |
|---|------------|---------------|------|

/44-42<sup>4</sup> 41#

**Ricambi Box Doccia Novellini**



**Pattini di ricambio per:  
HARMONY FANTASY - STAR**

**69782** CONF.RICPATTINI FAN/HA/ST NOV Art. RO3HAS P/C.



**Cuscinetti e pattini per:  
FANTASY - HARMONY**

**69783** CONF.CUSC/PATFANT.SOFF. NOV Art. R03FAS P/C.

**69784** CONF.CUSCUPATFA T.HAR/%I. NOV Art. R03F3A P/C.



**Pattini di ricambio per:  
HARMONY - STAR**

**69785** CONF.PATTIMRIC.HARMSTAR NOV Art. R02FAS P/C.



**Pattini e cuscini per:  
FANTASY - HARMONY - STAR**

**69786** CONF.CUSCUPATSTARIFANTA NOV Art. R02F3A P/C.

**69787** CONF.CUSC+PATFANTRAR.ST NOV Art. R03HAP.26 P/C.



PROFILO TUBOLARE 40x20 mm  
H: 1850 mm  
Colore: Bianco RAL 9010

PROFILO COMPENSMTVO

**69680** PROFILO COMP.x PORT.20x40 NOV Art. P20X4OST.26



PROFILO TUBOLARE 40x40 mm  
H: 1850 mm  
Colore: Bianco RAL 9010

PROFILO COMPENSATIVO

**69681** PROFILO COMP.x PORT.40x40 NOV Art. P40X4OST.26



**69682** PROFILO A SCATTO x BOX ANG NOV Art. P05HAAS.26 P/C.

**Box Doccia Economico  
Adattabile A Piatti Quadrati Da 70 A 80**



**Telaio in alluminio bianco.  
Lastra in metacrilato stilato.  
Adattabilità: 70 / 80 cm.  
COMPLETO DEI DUE LATI**

**TIPO ECONOMICO**

**66025** BOX DOCCIA 70/80 ANG. BIAN FRG P/C.1

**Vasche In Acciaio 22/10  
SMALTATE - BIANCHE**

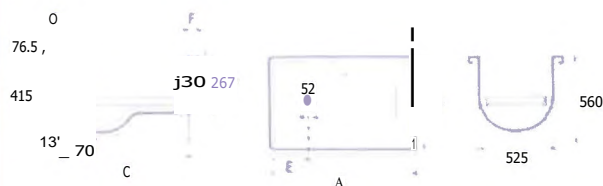

A	B	C	D	E	F	G	Capacità (lt)	Peso px. (kg)	per pallet
1050	650	925	55	281	52	48	93	17	13

**64100** VASCA A C 22/10 105x65 BIAN MER Art. 606071

**MIT'S  
GROUP**









- Otntenyont: cc-1120x in  
- verse..ne dO :pcasso.



DATI TECNICI		
DIMENSIONI CASSICIA		
VASCA	NUM	14N(1)
120.2*	112	131tg

B.J. = Blanco Ideai Standard BIA = Bianco Europeo

**62004** VASCA GOCCIA 120X70 BIA ITE Art. 810704

**62005** VASCA GOCCIA 120X70 B.I ITE Art. 810705



O e

D;me s r cr I40.70  
• Ite\*sione dd .nr asso

DATI TECNICI		
bx.*Pasam (INCITA' 14.50		
VASCA	N	VASCA
1A0 .70	111	143 Itg

B.J. = Blanco Ideai Standard BIA = Bianco Europeo

**62007** VASCA GOCCLI 140X70 BIA ITE Art. 810702

**62008** VASCA GOCCIA 140X70 B.I ITE Art. 810703

**S**  
GROUP

Crnensiorn: cm '50x/0.  
Ve;ucne ad \*ncasso.  
Vers\*one con gelato e pannelli.

MMLIMIPIM		
OssAitNSION	CAPActur	ISSO
VASCA	IN Dr*	VASCA
110.70	s Aks	i s

2\*

B.J. = Blanco Ideai Standard BIA = Bianco Europeo

**62009** VASCA GOCCIA 150X70 BIA ITE Art. 810700

**62010** VASCA GOCCIA 150X70 B.I ITE Art. 810701



Cd- PP,UPt: 110,70 a Ca  
• PP 11VOP JP Int &PAY  
- ,UVVP z. UP IPleln. P panne".

~18~12~1	
Ca...111314	Ondata 11X.1
aaalla	M Una \MICA
~M	no 1114
IMIS/41	ISAIA II



01

DIMENSIONI VASCHE					
51000	a:/	IH	>>	18	m '11
b./c	HO	In	n	b	

B.I. = Blanco Ideai Standard 614 = Bianco Europeo

**62000** VASCA AMACA 160X70 DIA ITE Art. 7095159

**62001** VASCA AMACA 160X70 B.IS ITE Art. 665610

**62002** VASCA AMACA 170X70 BIA ITE Art. 685549

**62003** VASCA AMACA 170X70 B.IS ITE Art. 685650

**62046** PANNELLO FRONT. 170x60 BIA ITE Art. 685302

**62034** PANNELLO FRONT. 160x60 B.I ITE Art. 681064

**62048** PANNELLO FRONT. 170x60 B.I ITE Art. 685303

**62049** PANNELLO LATER. 70x60 B.I ITE Art. 683018

**62027** TELAIO x VASCA ACR 170x70 ITE Art. 681321

**Alkra**  
GROUP

**Accessori Per Vasche Acritiche**



**62060 COLONNA SC C/EROGAZIONE CR** ITE Art. 683179



**62061 COLONNA SC S/EROGAZIONE CR** ITE Art 6831Bo

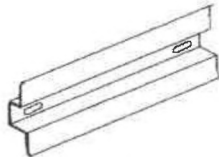

**KIT DI POSA**



Impiego coretto del kit d'posa loptionall per I lis-  
sagge del bordo vasca alla parete Ai a trio con la fine  
della p;astrellatura. Bi direttamente sulle o,;srelle

**62045 KIT FISSAGG MURO x VAS/ACR** ITE Art. 681311

**Profili Per Sigillare 11 Bordo Vasca  
AI Muro Ed Eliminare La Fessura**

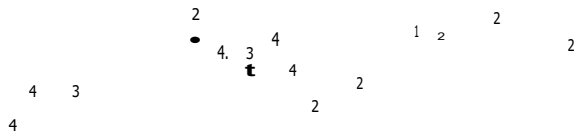

**61735 PROFILO x VASCA BIAN** JAC Art. 43004004

**61736 PROFILO x VASCA BIA/IS** JAC Art. 43004005

**Prodotti Per Trattamento Vasche  
Riparazioni E Pulizia**

O iJ poi •nlzzare le tubazioffi  
1rrqrI aggici. Si 'Jsil venendo

**a**

;PFEIiti

0,5 litri.

**62064 GREENET IGIENIZZANTE IDRO** ITE Art. GREENETPERL

Utilizzate con una spugna morbida elimi-  
na il cokare dalla vasca e dallo bocchet-

gradabile al 90%. Per monte-  
nere lo splendore della vostra  
vasca sempre intatta si consi-  
gl'a di r'petere questa opera-  
zone dopo cxdrii bagno.

**WZU**

;2,i,ri

Contento della bottiglia: 0,5 litri,

**62065 KALNET DETERGENTE x ACRIL.** ITE Art. KALNET



Valigetta con tutto l'occorrente per cancel-  
lare eventuali graffi dalla superficie della  
vasca: carta abrasiva di 5 gradazioni, pa-  
sta lucidante, spugnetta, panno e istruzioni  
per il corretto utilizzo. Grazie al Kit to Keep  
mantenere la vostra vasca sempre nuova è  
ancora più facile,

**62066 KIT MANUTENZ. VASCA/ACRIIDR** ITE Ari- 681345





138 103  
 I i max.45  
 max.  
 350 300  
 034, .20° 40  
 -4.1063  
 max.55  
 106 e.  
 Me<sup>9243</sup>  
 -re max.190  
 55°  
 55°

**70734 EUROSTYLE MIX BIDET CR** GRO Art. 33565 P/C.

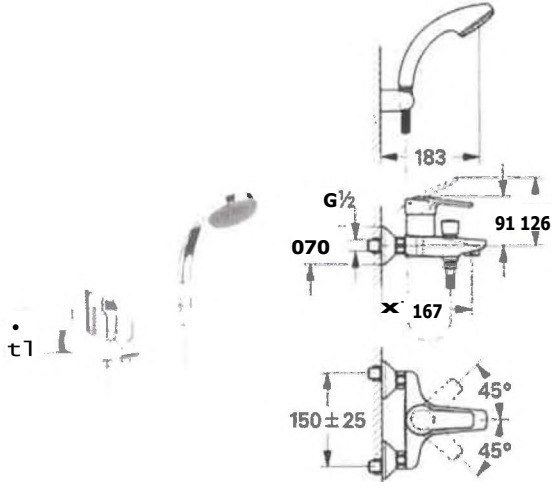

**70735 EUROSTYLE MIX VASCA C/D CR** GRO Art. 33592 P/C.

e  
 410.

Miscelatore monocomando da 1/2" per doccia, cartuccia a dischi ceramici, attacco flessibile da 1/2" Senza dotazione doccia. Cromo.

**70736 EUROSTYLE MIX EST DOCC CR** GRO Art. 33590 P/C.



66-96,  
 15-45,  
 0% !  
 x 150  
 186  
 121  
 459 45° G1/2  
 »72  
 4.;68-98-  
 .-101-131r.

**70737 EUROSTYLE INC DOC C/DEV CR** GRO Art. 33637 P/C.



66  
 15-45,  
 GY2  
 -e 150  
 G1/2  
 186  
 git  
 121  
 i i  
 G1/2,  
 12  
 -i.468-98-  
 \*-101-131-.

**70738 EUROSTYLE INC DOC S/DEV CR** GRO Art. 33635 P/C.

161 126  
 0.34  
 max.60  
 4543  
 -240  
 /, 45°  
 O., 1 140°  
 , 45°  
 ft

**70740 EUROSTYLE LAVELLO MONOF CR** GRO Art. 33977 P/C.

r

Miscelatore monocomando da 1/2" per lavello, cartuccia a dischi ceramici, bocca alta girevole con mousseur. Cromo.

**70741 EUROSTYLE LAVELLO B/ALT CR** GRO Art. 33975 P/C.

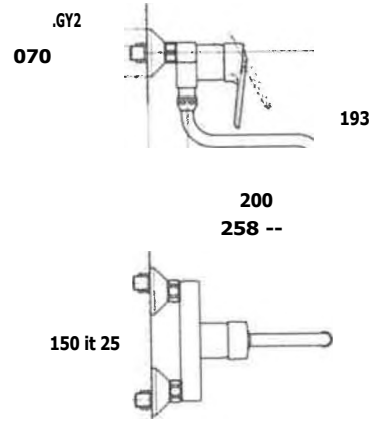
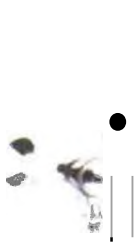

**70742 EUROSTYLE LAVELLO MURO CR** GRO Art. 33982 P/C.

**Eurodisc Cromato**

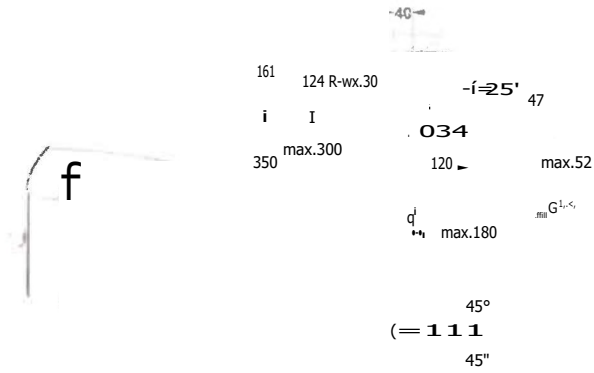

**70624 EURODISC MTX LAVABO CR** GRO Art. 33190 NUO P/C.1

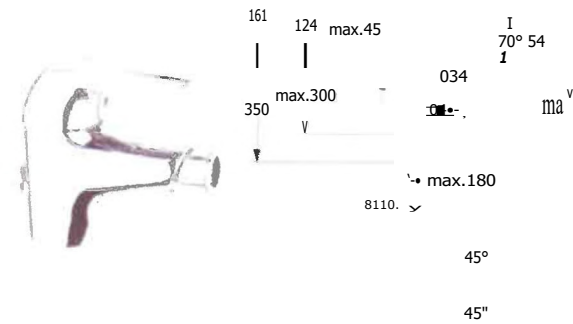

**70625 EURODISC MIX BIDET CR** GRO Art. 33244 - NUO P/C.1

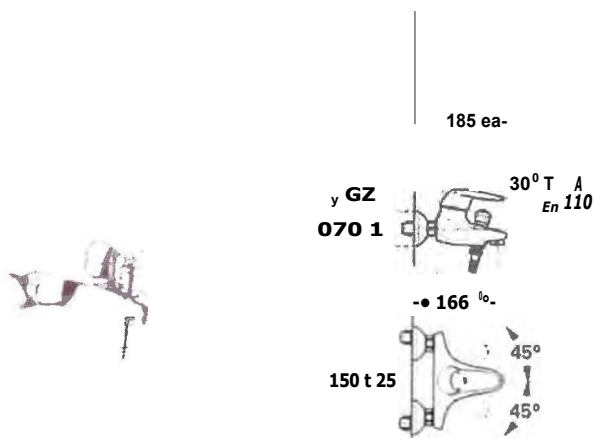

**70626 EURODISC MIX VASCA CR** GRO Art. 33394 - NUO PC.1

**GROHE**

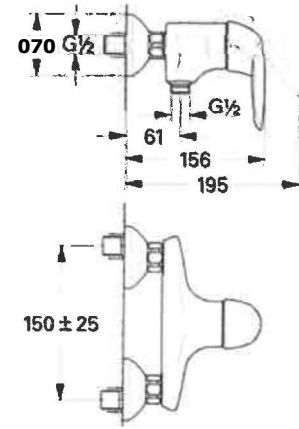

**70618 EURODISC MIX EST DOCCIA** GRO M. 33570

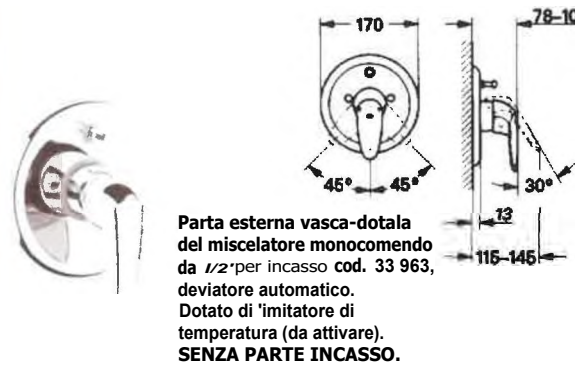

**70629 EURODISC ROSONE DOC C/DEV** GRO Art. 19548 P/C.

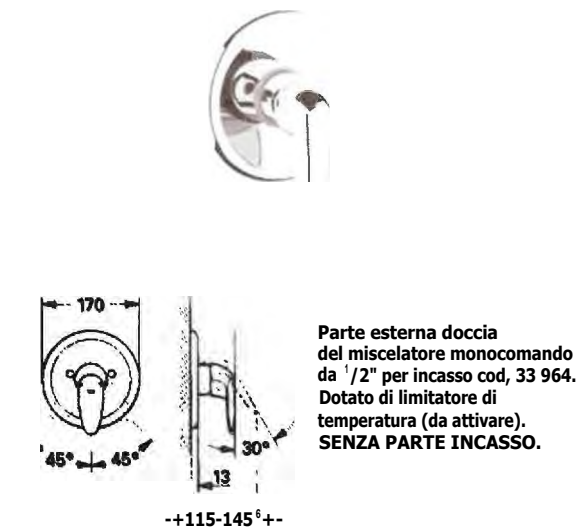

**70630 EURODISC SOLO ROSONE S/DEV** GRO Art. 19549 P/C.1

**GROHE**

**Grohe Corpi Incasso Per Mix Doccia  
Per Tutte Le Serie**

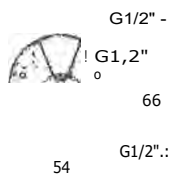

**-15-45** **Corpo per incasso doccia**  
miscelatore monocomando da  
cartuccia a dischi ceramici  
Dotato di limitatore di portata  
(da regolare).  
**SENZA PARTE ESTERNA**

**45-75** **DISPONIBILE IN CONFEZIONE  
DA 10 PEZZI.**

**70622 CORPO INCASSO S.DEV UNIVER** GRO Art. 33964 P/C.1

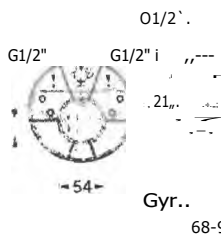

**-15-45**  
**Corpo per incasso vasca-doccia**  
miscelatore monocomando da tr2  
cartuccia a dischi ceramici.  
Dotato di limitatore di portata  
(da regolare).  
**SENZA PARTE ESTERNA.**

68-98 •

**70623 CORPO INCASSO C.DEV UNIVER** GRO Art. 33963 PIGI

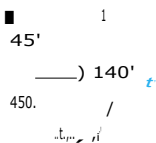
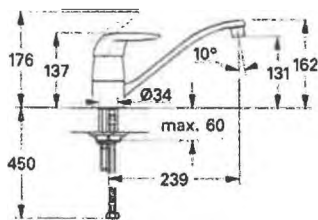

**70619 EURODISC MIX LAVELLO MONOF** GRO Art. 33770 P/C.

**GROHE**

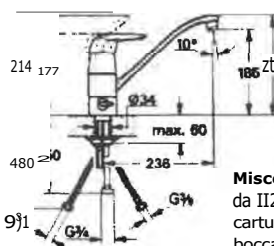

••: 46

**Miscelatore monocomando**  
da II2' per lavabo.  
cartuccia a dischi ceramici,  
bocca alta girevole con mousseur.  
Dotato di limitatore di  
portata (da regolare).  
**Completo di rubinetto per lavastoviglie,**

**70621 EURODISC MIX LEVEL A/LAVAT** GRO Art. 33312

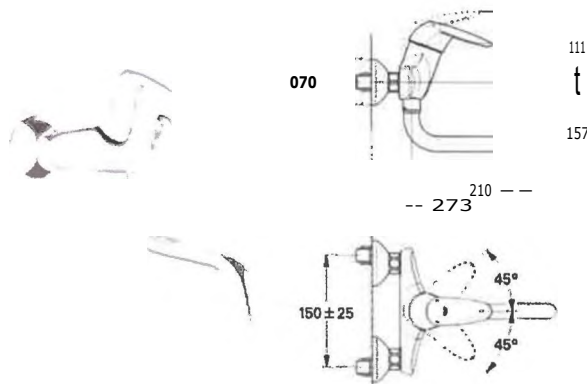

**70628 EURODISC MIX LEVEL MURO CR** GRO Art. 33772 - NUO P/C.1

**GROHE**



**Eurowing  
Cromato**

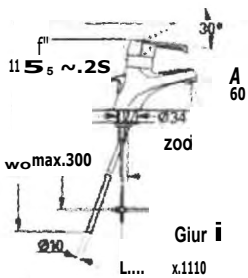

**Miscelatore monocomando da 1/2" per lavabo, cartuccia a dischi ceramici, bocca con mousseur, scarico a saltarello. Dotato di limitatore di portata (da regolare). Disponibile limitatore di temperatura (da attivare) come accessorio**

**DISPONIBILE IN CONFEZIONE DA 10 PEZZI SOLO CROMO.**

**70655 EUROWING IVBX LAVABO**

GRO Art. 33085 P/C.1

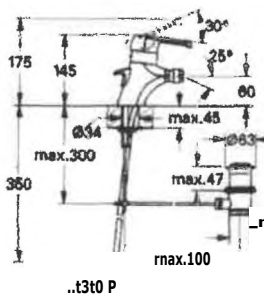

**Miscelatore' monocomando da 1/2" per bidet, cartuccia a dischi ceramici, bocca con mousseur orientabile, scarico a saltarello. Dotato di (imitatore di portata (da regolare). Disponibile limitatore di temperatura (da attivare) come accessorio**

**DISPONIBILE IN CONFEZIONE DA 10 PEZZI SOLO CROMO.**

**70656 EUROWING MIX BIDET**

GRO Art. 33237 P/C.1



**Miscelatore monocomando da 1/2" per vasca-doccia, cartuccia a dischi ceramici, attacco flessibile da 1/2", deviatore automatico, valvola di ritegno all'attacco dei flessibile, dotazione doccia con manopola Relexa plus"Massaggio soft" con sistema anticalcare "Speed Clean", supporto murale e flessibile da 1500mm. Dotato di (imitatore di portata (da regolare) Disponibile limitatore di temperatura (da attivare) come accessorio**

**70657 EUROWING MIX VASCA**

GRO Art. 33469-33441 P/C.1

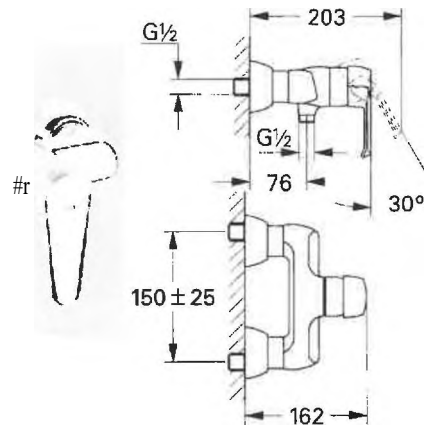

**70665 EUROWING MIX EST DOCCIA**

GRO Art. 33679 P/C.

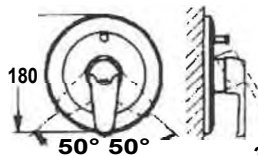

**Parte esterna vasca-decelsa del miscelatore monocomando da 1/2" per incasso**

**deviatore automatico. 30° Disponibile limitatore di temperatura (da attivare) come accessorio**

105-13

**70662 EUROWING ROSONE C/DEV**

GRO Art. 19520 P/C.1

**GROHE**

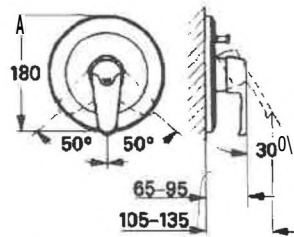

**Parte esterna doccia**  
del miscelatore monocomando  
da 1/2" per incasso

Disponibile limitatore di  
temperatura (da attivare)  
come accessorio

**70663 EUROWING ROSONE S/DEV** GRO Art. 19521 P/C.1

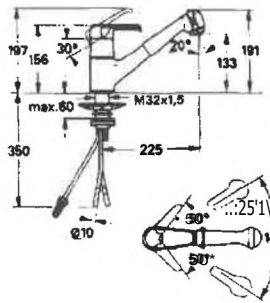

**Miscelatore monocomando**  
per lavello,  
cartuccia a dischi ceramici,  
**bocca girevole,**  
**doccetta estraibile a 2 getti,**  
**flessibile da 1500mm.**

Dotato di limitatore di temperatura (da attivare)  
come accessorio

**70660 EUROWING MIXLAVELLO C/DOC/E** GRO Art. 33809 P/C.1

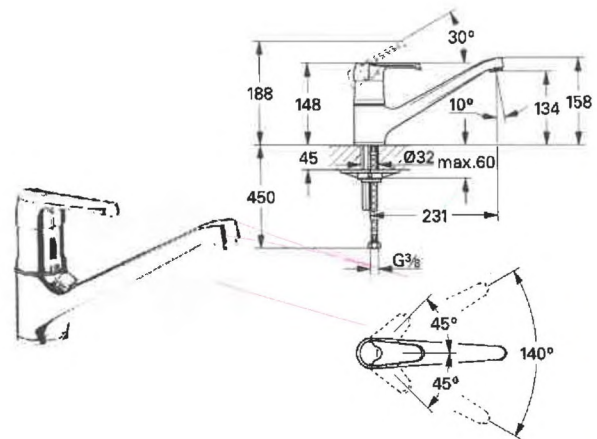

**70661 EUROWING MIXLAVELLO** GRO Art. 33807 P/C.1



**Eurowing**  
**Cromo-Oro**

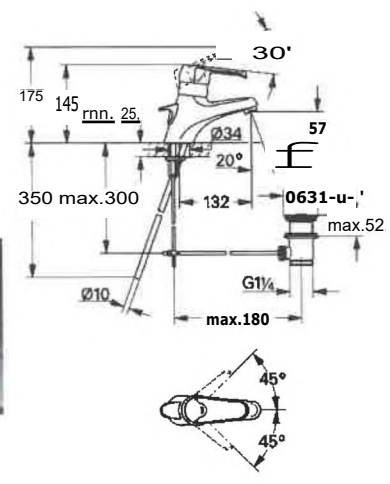

**70666 EUROWING LAVABO CR/ORO** GRO Art. 330851G P/C.1

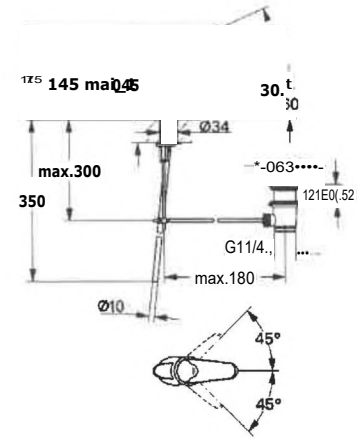

**70667 EUROWING BIDET CROMO/ORO** GRO Art. 332371G P/C.1

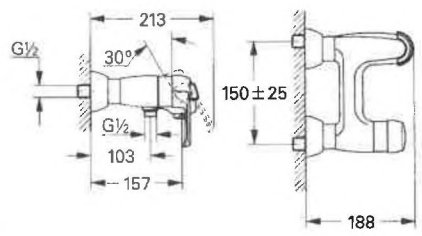

**70668 EUROWING VASCA CROMO/ORO** GRO Art. 334681G P/C.1





**Europlus DUE Cromato**

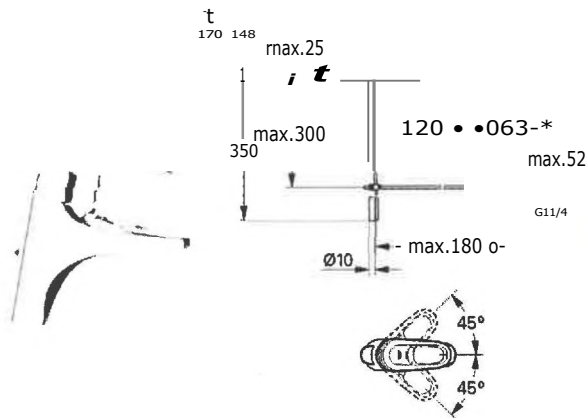

70670 EUROPLUS DUE MIX LAVABO CR GRO Art. 33153 P/C. 1

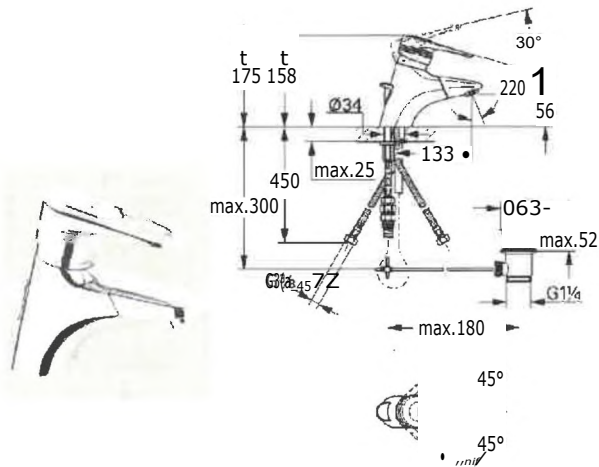

70671 EUROPLUS 2 MIX LAVAR DIEST GRO Art. 33155 P/C.



**Europlus Due**  
Miscelatore monocomando da 1/2" per bidet, cartuccia a dischi ceramici 46 mm., bocca con mousseur orientabile.

70673 EUROPLUS DUE MIX BIDET CR GRO Art. 33241 P/C. 1

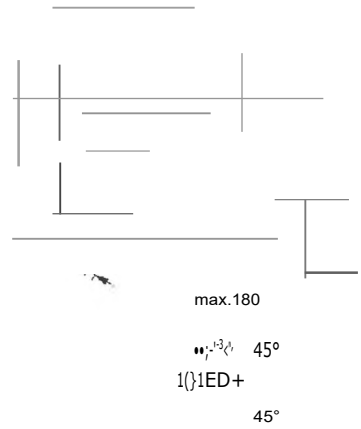

70672 EUROPLUS 2 MIX BIDET D/EST GRO Art. 33242 P/C.



**Europlus Due**  
Miscelatore monocomando da 1/2" per vasca-doccia, cartuccia a dischi ceramici, deviatore automatico. Completo di dotazione doccia con manopola Relaxa Plus anticalcare tipo "idromassaggio", -- supporto murale fisso e flessibile da 1500 mm.

70674 EUROPLUS DUE MIX VASCA CR GRO Art. 33546 P/C. 1

**Europlus Mie**  
Miscelatore monocomando da 1/2" per doccia, cartuccia a dischi ceramici, attacco flessibile da 1/2". Senza dotazione doccia.

70675 EUROPLUS DUE DOCCIA EST CR GRO Art. 33577 P/C. 1

**GROHE**

**GROHE**



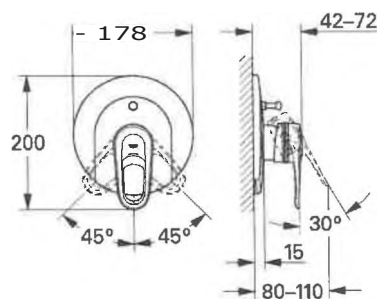

70680 EUROPLUS DUE ROSONE C/D.CR GRO Art. 19536 P/C.1

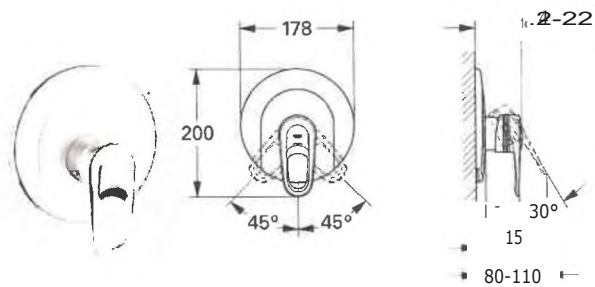

70681 EUROPLUS DUE ROSONE S/D.CR GRO Art. 19537 P/C.1

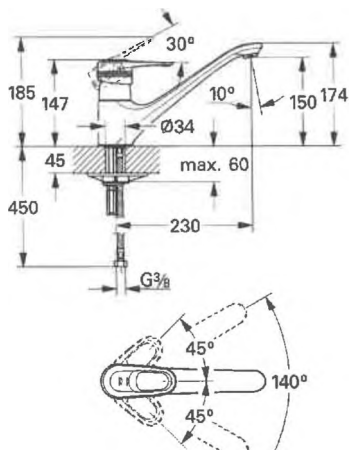

70676 EUROPLUS DUE LAVELLO CR GRO Art. 33930 P/C.1

**GROHE**

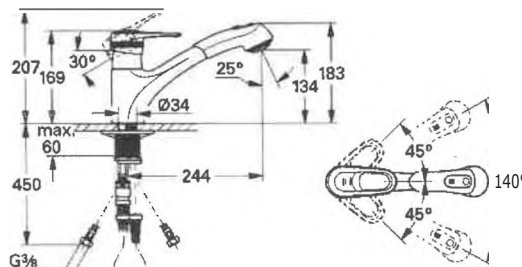

70677 EUROPLUS DUE LAVELLO C/DOC C GRO Art. 33933 P/C.1

**Doccette Ricambio Europlus**

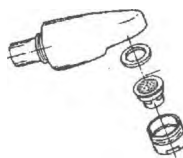

**Doccetta di ricambio per EUROPLUS Lavabo**

74781 DOCCETTA x MIX LAV EU-PLUS GRO Art. 46103 P/C.1



**Doccetta di ricambio per EUROPLUS lavallo**

74788 DOCCETTA x EUROPLUS BI GRO Art. 46252L P/C.1

74761 DOCCETTA x EUROPLUS GRI GRO Art. 46252xx P/C.1

**Chiara Cromato**

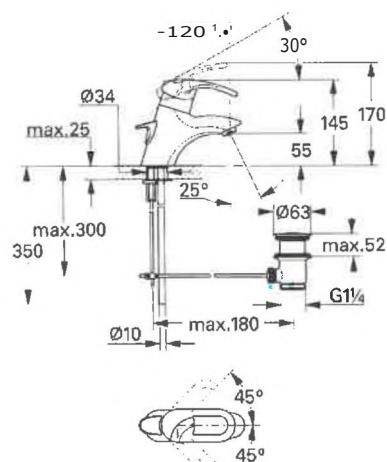

70766 CHIARA MIX LAVABO CROMO GRO Art. 33001 P/C.1

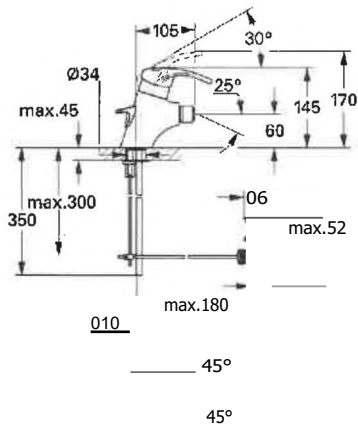

**70767 CHIARA MIK BIDET CROMO** GRO Art. 33201 P/C.1

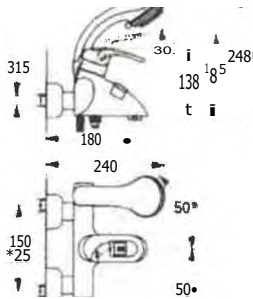

**Miscelatore monocomando** da 1/2" per vasca-doccia, cartuccia a dischi ceramici, attacco flessibile da 1/2", bocca con rousseur, valvola di ritegno all'attacco del flessibile, deviatore automatico, dotazione doccia con manopola Relaxa plus "Massaggio soft" **anticalcare** e flessibile da 1500mm. Dotato di limitatore di portata e imitatore di temperatura (da attivare),

**70768 CHIARA MIA' VASCA CROMO** GRO Art. 33419 P/C.1

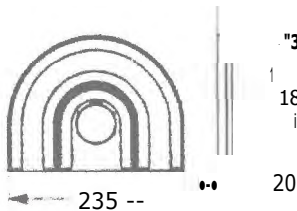

**'Parte esterna doccia** "3" del miscelatore termostatico da 1/2" o da 3/4" per incasso 180 manopola graduata per impostare la temperatura con blocco di sicurezza a 38°. **COMPLETA DI MANOPOLA.**

**70779 PARTE EST x DOC TERM CHIAR** GRO Art. 19610 P/C.1



**70778 CORPO INCAS TERMOST CHIARA** GRO Art. 34305 P/C.1  
Corpo per incasso doccia in miscelatore termostatico da 3/4", valvole di ritegno, valvole d'arresto e lift.  
Adatto per scaldabagni stantane e ad accumulo  
**SENZA PARTE ESTERNA**

**70778 CORPO INCAS TERMOST CHIARA** GRO Art. 34305 P/C.1

r4

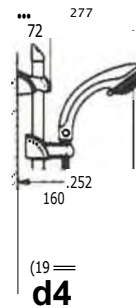

**Ricambi Lift**  
Sat asta doccia lunga 600mm. modello sarta "Chiara" con supporto scorrevole, completo di:  
asta doccia  
manopola **anticalcare** "TOP 4" a quattro getti: largo normale, stretto forte, tipo "massaggio soft" e tipo ArOMassaggio  
portasapone scorrevole e flessibile da 1500mm.

**74767 ASTA DOCCIA 600 mm CHIARA** GRO Art. 28715 P/C.1

**Ricambi per asta doccia**

**74724 PORTASAPONE PER SAL 74767** GRO Art. 28675 P/C.1

**74723 SUPPORTO SCOR x SAL 74767** GRO Art. 28672 - HAN P/C.1

**Chiara Cromo-Oro**

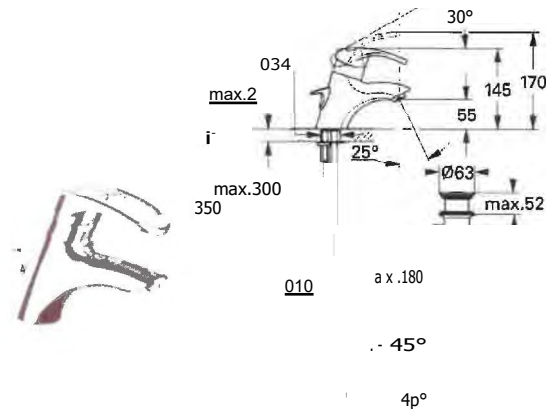

**70769 CHIARA MIX LAVABO CR.ORO** GRO Art. 33001 IG P/C.1



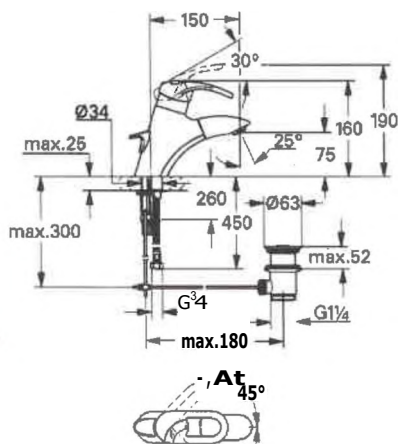

70770 CHIARA MIX LAVABO BOC ES7R GRO Art. 33003 IG P/C.1

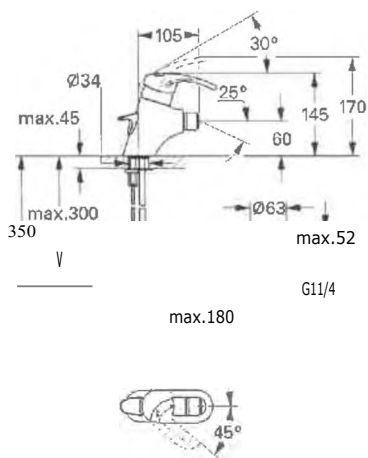

70771 CHIARA MIX BIDET CROMO/ORO GRO Art. 33201 IG P/C.1

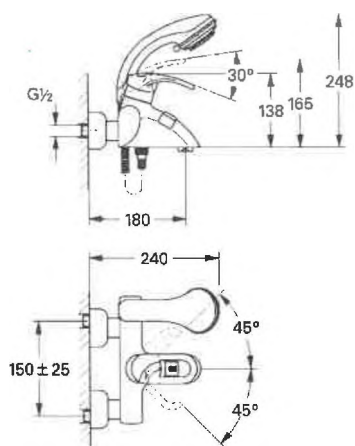

70772 CHIARA MIX VASCA CROMO/ORO GRO Art. 33419 IG P/C.1

GROHE

Adria Cromata

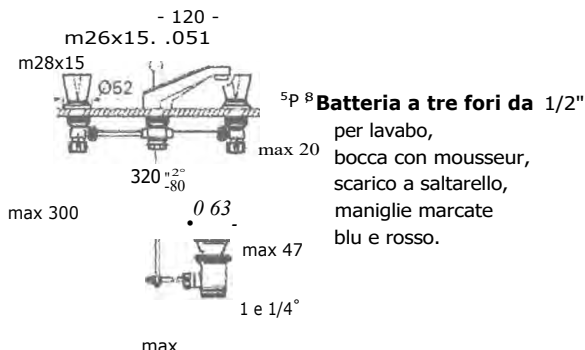

70802 ADRIA BATTERLO LAVABO 3F GRO Art. 20711 P/C.1

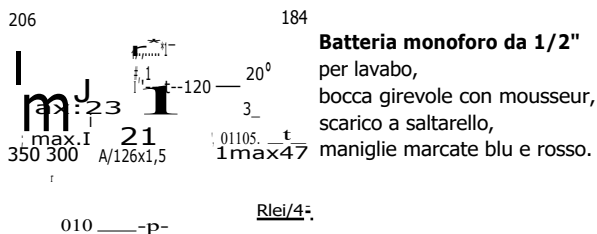

70809 ADRIA BATT LAVABO MONOF GRO Art. 21378 P/C.1

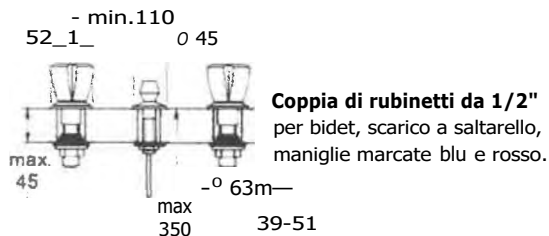

70803 ADRIA BATTERIA BIDET 3F GRO Art. 18881 P/C.1



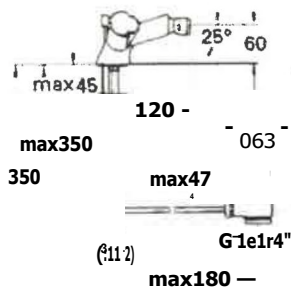

**Batteria monoforo da 1/2"**  
per bidet,  
bocca con mousseur orientabile,  
scarico a saltarello,  
maniglie marcate blu e rosso.

70810 ADRIA BATT. BIDET MONOFORO GRO Art. 24480 P/C. 1



70812 ADRIA BATT. LAVELLO MONOFORO GRO Art. 31813 P/C. 1



**Batteria monoforo da 1/2"**  
per lavello,  
bocca alta girevole cori  
mousseur, sporgenza 185mm  
maniglie marcate blu e rosso,  
senza portacatenella.

260 - 185  
max 25  
200  
M26x1,5  
350 J 010  
52

DISPONIBILE IN CONFEZIONE  
DA 10 PEZZI.

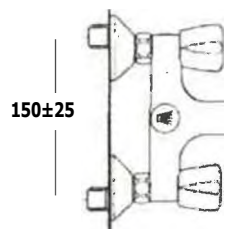

**Batteria per vasca-doccia**  
da 1/2", attacco flessibile da  
1/2", bocca con mousseur,  
deviatore automatico, maniglie  
marcate blu e rosso, dotazione  
doccia con manopola Relexa  
nera, flessibile da  
1500mm. , sostegno murale  
snodabile.

70801 ADRIA GRUPPO VASCA EST C/D GRO Art. 25467 P/C. 1

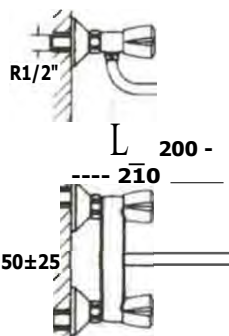

**Batteria a muro da 1/2"**  
per cucina,  
bocca a "S" girevole  
con mousseur,  
maniglie marcate blu e rosso.

DISPONIBILE IN CONFEZIONE  
DA 10 PEZZI.

70805 ADRIA BATTERIA LAVELLO PAR GRO Art. 31187 P/C. 1

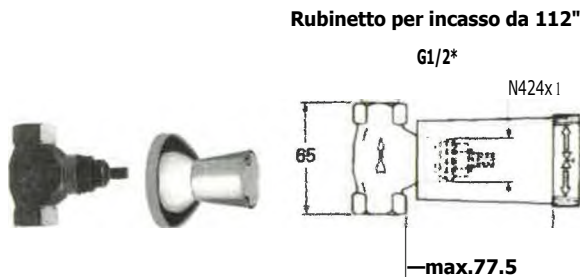

**Rubinetto per incasso da 112"**

70807 ADRIA RUBINETTO INC. 1/2 GRO Art. 29800+19806 P/C. 1

70808 ADRIA RUBINETTO INC. 1/2 GRO Art. 29800+19807 P/C. 1

**Mix Termostatici Grohe**

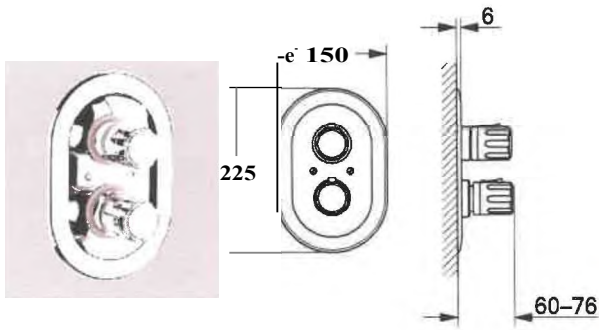

- 74701 CORPO x MIX TERMOST 34310 GRO Art. 34954 P/C.1
- 74702 ESTERNO x MIX TERMOS 34310 GRO Art. 19605 P/C.1

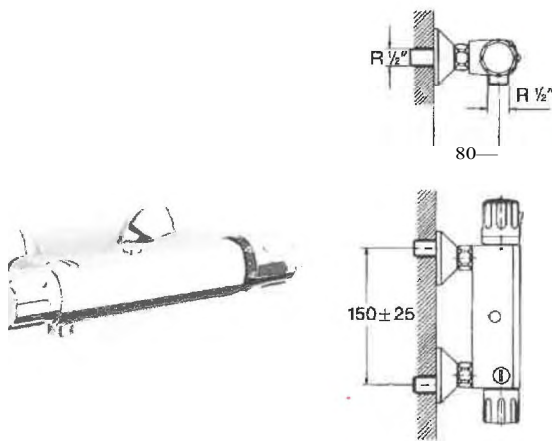

- 74704 MIX TERMOST EST x DOCCIA GRO Art. 34650 P/C.1

**Mix Ladylux Da Lavello MOI0foro**

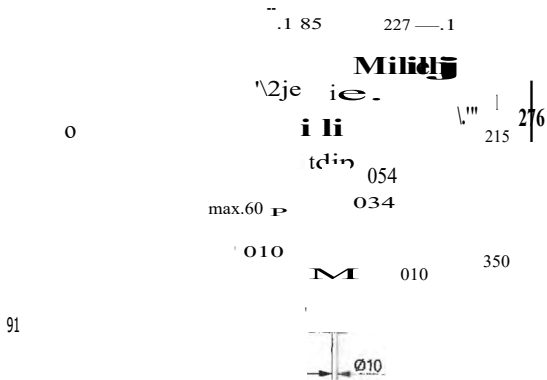

- 74711 MIX LAVEL. LADILUX BIANCO GRO Art. 33710L P/C.1

**GROHE**

**Ricambi Ladylux**

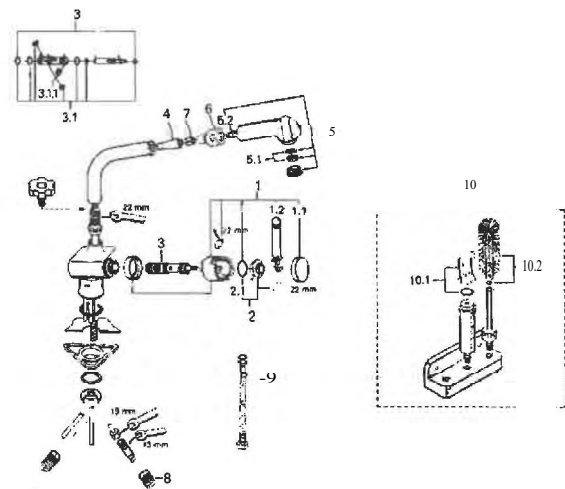

- 74773 DOCCETTA X LADYLUX BIANCA GRO Art. 46050 L P/C.1

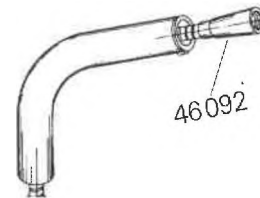

- 74776 FLESSIBILE x LADYLUX GRO Art. 46092 P/C.1

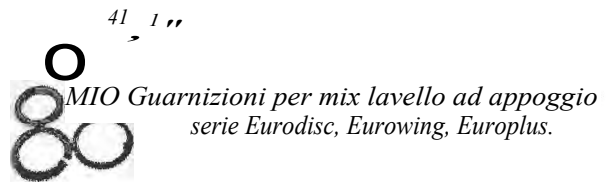

- 74718 SET GUARNIZIONI x 33891 GRO Art. 46077 P/C.1

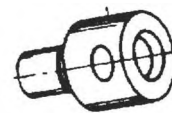

- 74784 RACCORDO A UT x LA DY GRO Art. 08568 P/C.1



- 74785 PIASTRINA x LADYLUX GRO Art. 46045L P/C.1

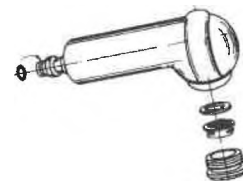

- 74786 DOCCIA x LADYLUX GRO Art. 46050H P/C.1

**GROHE**



**Ricambi Vari Grohe**



**PARTE DI RICAMBIO**  
**Vitone "Carbodurn"**  
 a dischi ceramici da 1/2"  
**Per serie ADRIA**

**74725 VITONE CER CARBODUR GRO Art. 45346 P/C.1**



**Placca cromata**  
**per EUROPLUS**  
**(Vecchia serie)**

**74771 PLACCHETTA EU-PLUS CROMATA GRO Art. 88 889 3 P/C.1**



**Bocca a "5" lunga 200mm.**  
 con mousseur.

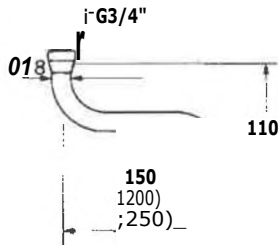

**74778 BOCCA S 200 mm GRO Art 13084 P/C.1**



**Bocca da 1/2" per lavabo,**  
 con mousseur, rosetta,  
 sporgenza 200mm.

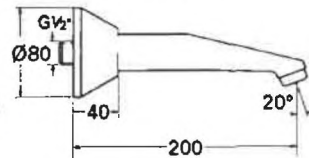

**74779 BOCCA LAVABO 200 mm GRO Art. 13535 P/C.1**



**Bocca da 3/4" per vasca,**  
 con mousseur, rosetta bassa,  
 sporgenza 140/150mm .

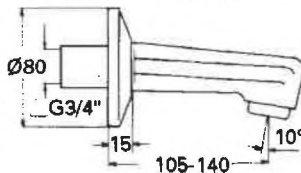

**74780 BOCCA VASCA INC 140 GRO Art. 13544 P/C.1**



**Flessibile per doccia**  
**EUROPLUS**  
**Attacchi: M15 x 1/2"**  
**Lungh: 700 mm**

**74782 FLESSIB COMPL 700 mm EU-PL GRO Art. 46104 P/C.1**



**74787 LEVA EUROPLUS GRO Art. 46100 P/C.1**



**PARTE DI RICAMBIO**  
**Cartuccia a dischi ceramici**  
**con (imitatore di portata**  
 per rubinetterie serie  
 CHIARA, EUROPLUS DUE,  
 EUROPLUS, EUROWING,  
 EURODISC, EUROECO,

**74789 CARTUCCIA EURODISC GRO Art. 46048 P/C.1**



**Grasso speciale per O-ring .**  
**CONFEZIONE 15 PEZZI .**

**74790 TUBETTO GRASSO x OR GRO Art. 45589 P/C.1**



**PARTI DI RICAMBIO**  
**Cartuccia in teflon**  
 per rubinetti serie EUROMIX.

**74791 CARTUCCIA TEFLON MIX GRO Art. 07000 P/C.1**



**PARTI DI RICAMBIO**  
**Testata EUROMIX.**  
**Leva per testata EUROMIX**

**74795 TESTATA SENZA LEVA GRO Art. 46023 P/C.1**

**74717 LEVA CON GANASCE GRO Art. 46027 P/C.1**



**74798 PIASTRINA COP EUROD**Gno Art. 46063 P/C.1



**74792 VITONE 1/2** GRO Art. 07146 P/C.1

**PARTI DI RICAMBIO**  
**1/1tone LONG-UFÉ da 112"**  
por incasso e  
rubinettene serie ADRIA e  
ATLANTA.



47  
37

G<sup>3/4</sup>  
i

69 Raccordo verticale

max.15

L  
032

Non utilizzabile per le serie  
FLORIDA, CHIARA,  
EUROPLUS ed EUROWING.

G<sup>1/2</sup>

**74775 RACCORDO VERT** GRO Art. 12030 P/C.1

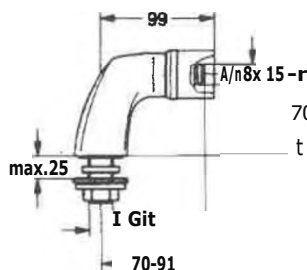

**Raccordo verticale,**  
attacco sul bordo vasca,  
per gruppi vasca-doccia da 1/2"  
delle serie EUROPLUS ed  
70 EUROWING.

**74793 RACCORDO VERTICALE**GRO Art. 46121 P/C.1



**Grohclean Spray detergente**  
per la pulizia dei rubinetti.  
CONFEZIONE 12 PEZZI.

**74794 LIQUIDO DETERG. GROHCLEAN** GRO Art. 45347 P/C.1



180

**PORTE DI RICAMBIO**  
**Ghiera thstanziatrite da 22mm.**  
per miscelatori monocomando  
parte esterna



**74799 GHIERA DISTANZ** GRO Art. 46035 P/C.1

**Ricambi Casette Grohe Dhal**

**Calotta per sallscendi**

**74715 CALOTTA x 28620** ORO Art. 45652 P P/C.1



**74716 CHIAVE x MOUSSEUR** GRO Art. 45537 P/C.1

**GROHE**



**Rubinetteria Idea! Standard  
Serie Ceramix 2000**

*Ideai  
Siato 'rct'*

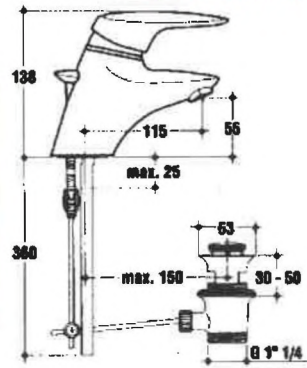

**73275 CERA MIX 2000 GR LAVABO CR** IDE Art. A5011M P/C.

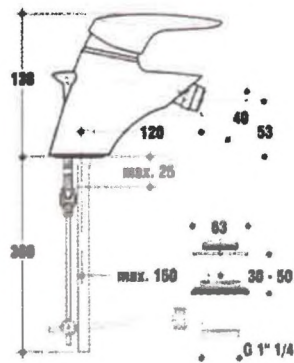

**73270 CERAMIX 2000 GR BIDET CR** IDE Art. A5016AA

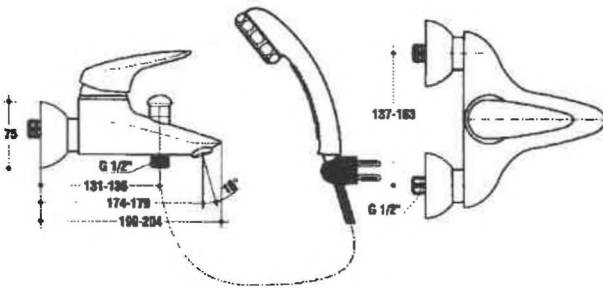

**73272 CERAMDC 2000 GR EST VASC/D** IDE Art. A5020M M.

*IaW  
Sia ola d*

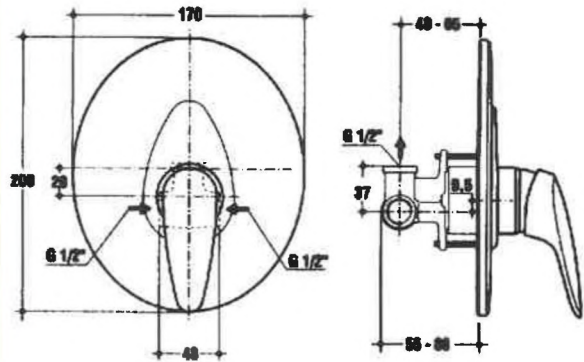

**73271 CERAMDC 2000 GR DOCCIA INC** IDE Art. A5026AA P/C.

**Serie Ceramc**

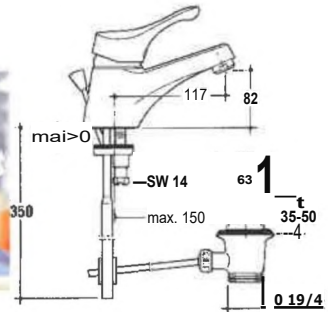

**73201 CERAMIX GR MON LAVABO** IDE Art. A1247-1515 P/C. 1

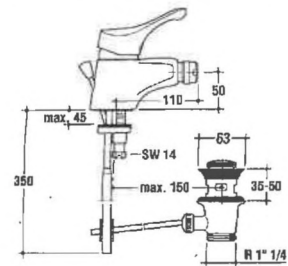

**73205 CERAMX GR BIDET** IDE Art. A1 182AA P/C.1

*Idea  
Siz Idan'*

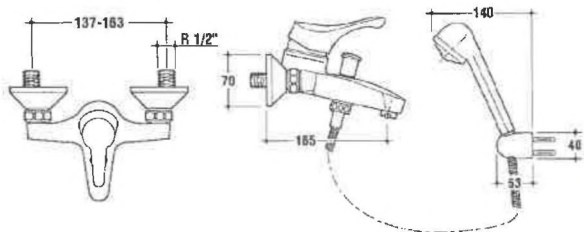

73211 CERAMIX GR EST VASC/D IDE Art. A1667AA P/C.1

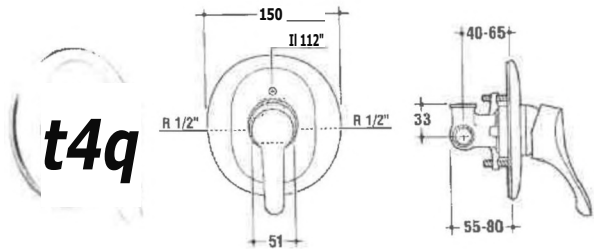

73208 CERA MIX GR DOCCIA IDE Art. A1985AA P/C.1

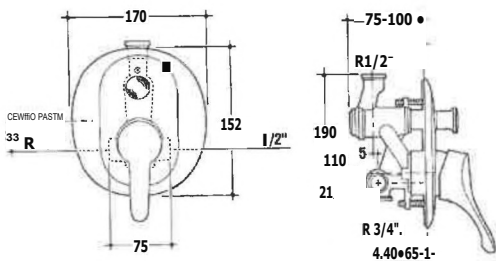

73209 CERAMIX GR INC VASC/D IDE Art. A1993AA P/C.1

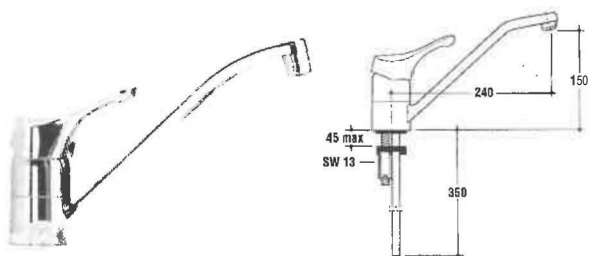

73203 CERAMIX GR LAVELLO IDE Art. A2710AA P/C.1

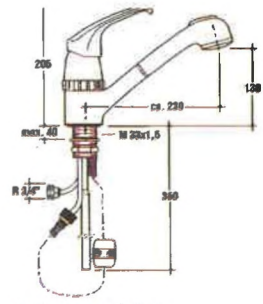

PER ATTACCO LAVASTOVIGLIE

73202 MIX LAVELLO DOC/ESTR x LAV IDE Art. A2714AA P/C.1

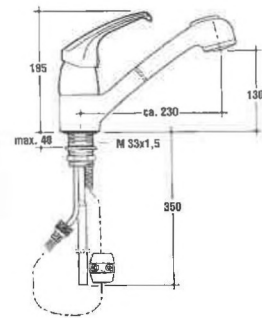

73204 MIX LIVELLO DOC/ESTR IDE Art. A2715AA A/C.1

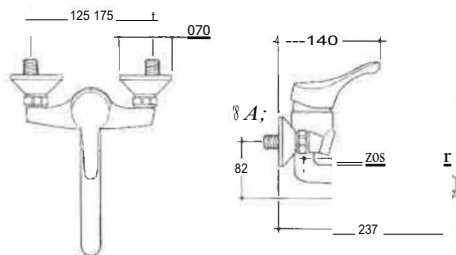

73214 CERAMIX GR LAVEL PAR IDE Art. A 2520 P/C.1

Idea/  
Sito, tim-tt'



# Ceraplano

## Ceraplano

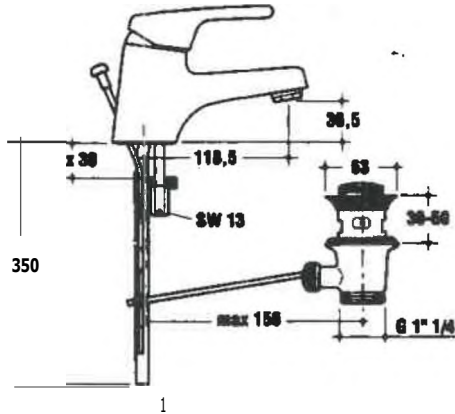

Miscelatore monocomando per lavabo con bocca derogazione fissa dotata di rompigetto 24 x 1, con asta di comando scarico e piletta da 1-1/4",

**B 1109AA**

**73253 CERA.PLAN GR LAVABO CROM IDE** Art. 131109AAP/C.1

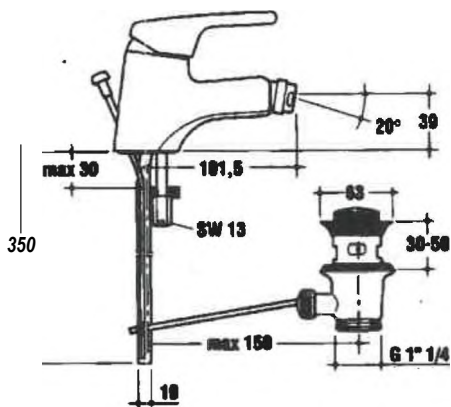

Miscelatore monocomando per bidet con bocca d'erogazione fissa dotata di getto orientabile e rompigetto 24 x 1, con asta di comando scarico e piletta da 1-1/4"

**e 1195AA**

**cromato**

**73254 CERAPLAN GR BIDET CROM IDE** Art. B1195AAP/C.1

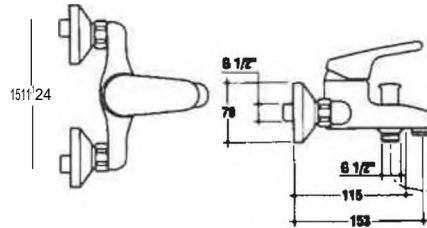

Miscelatore monocomando esterno per vasca/doccia con deviatore automatico, tocca derogazione dotata di 24 a t, raccordi ad S da lir regolabili per interame da 1 S0 \*24 non. E corredato di doccetta supporto fisso e tubo fleatibbe da 1500 non, raccordo conico da 1/2".

**B1125AA**

**cromato**

**73255 CERAPLAN GR VASCA/DOC CROMIDE** Art. B1125MP/C.1

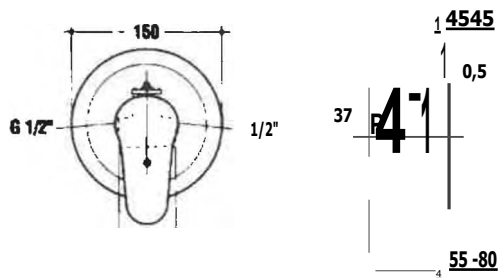

Miscelatore monocomando ad incasso per doccia con attacchi, alimentazione e scarico alla doccia da 1/2". Non è corredato di componenti doccia.

**ABBINAMENTI CONSIGLIATI**

Doccetta due funzioni A6016 - A2233 e asta murale T8840, oppure con soffione alto due funzioni N8910.

**A 2749AA**

**cromato**

**73256 CERAPLAN GR „WC DOCC CROM IDE** Art. A2749AA P/C.1

*Sinkitúrd*

## Talent

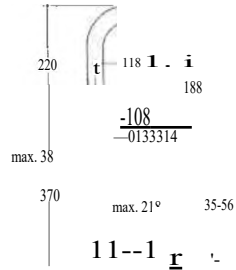

**73216 TALENT GR LAV CROM** IDE Art. N9044GY P/C.1

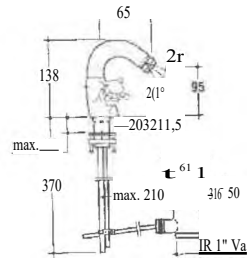

**73217 TALENT GR BID CROM** IDE Art. N9050GY P/C.1



R1/2"

138°182

112"

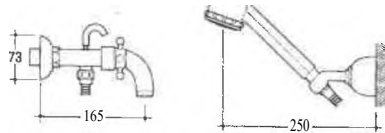

**73218 TALENT GR VAS CROM** IDE Art. N9054GY P/C.1

### Ricambi Per Ceramix



**Cartuccia UNIVERSALE**  
(per serie prodotte dopo il 1983)

**73221 CARTUCCIA CPL 4 GALLONI** IDE Art. 0960463 P/C.1



**Per Ceramix Lavabo**  
(serie prodotte tra il 1972 e il 1974)

**73235 CARTUCCIA 4 GALLONIIDE** Art. 0962552 P/C.1



**Per Ceramix Doccia, Vasca/doccia**  
**ad incasso ed esterno**  
(prodotti tra il 1975 e il 1983)

**73236 CARTUCCIA 8 GALLONIIDE** Art. 0961710 P/C.1

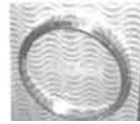

Per Ceramix gruppo incasso doccia  
finitura cromata.

**73237 PROLUNGA PIASTRA** IDE Art. 0961163 P/C.1

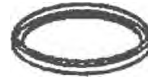

**Per miscelatori lascito monoforo**  
**serie Corea\***

**73238 O RING + TEFLON** IDE Art. 0961175 P/C.1

**73239 O RING + TEFLON** IDE Art. 0961177 P/C.1

**73246 O RING + TEFLON A1520/21** IDE Art. 0961176 P/C.1

ti

**73268 DADO E GUARNIZ FISSA 1521** IDE Art. 0960431 P/C.1



Per Ceramix tipo nuovo (n°1).

**73240 MANIGLIA CPL N.1 CR** IDE Art. 0960699 P/C.1

.451ri

**73247 DEVIATORE AUTOMAT/MANUALE** IDE Ad. 0963093 P/C.1

**Rubinerie Sol**  
**Punta**

**SOL a<sup>5</sup>**

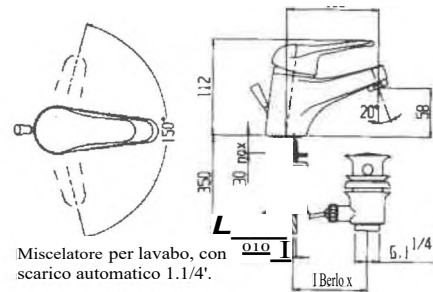

**73502 MIX LAVABO PUNTA CR** SOL Art. 11376-001 P/C.1

**SOLO**  
RUBINETTERIA



Miscelatore per lavabo tipo Punta con scarico automatico 1.1/d" con 1~ lunga

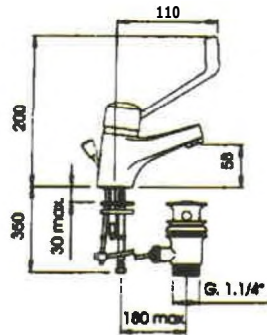

73501 MIX LAVABO PUNTA LEVAL UNGA sa\_ Art. 11399001/C P/C.1

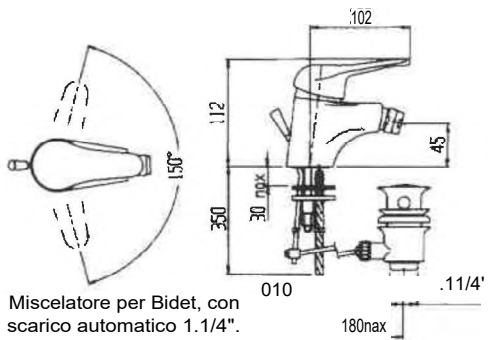

Miscelatore per Bidet, con scarico automatico 1.1/4\".

73503 MIX BIDET PUNTA CR SOL Art. 11476-001 P/C.1

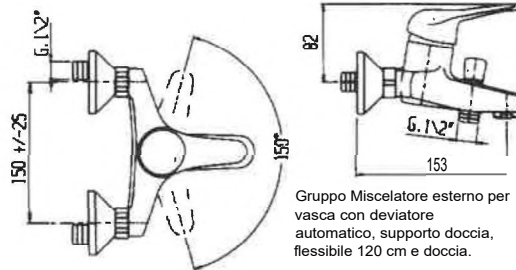

Gruppo Miscelatore esterno per vasca con deviatore automatico, supporto doccia, flessibile 120 cm e doccia.

73504 MIX VASCA C/D PUNTA CR SOL Art. 11176-001 P/C.1

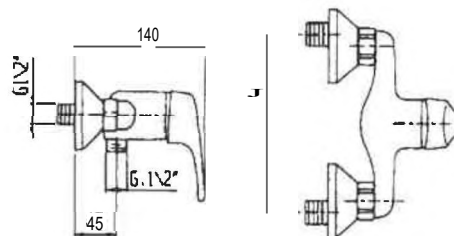

Miscelatore Esterno per Doccia, senza flessibile e doccetta, uscita inferiore da 1/2\".

73510 MIX EST DOCCIA PUNTA CR SOL Art. 11276-001 P/C.1

Miscelatore da incasso per doC0a

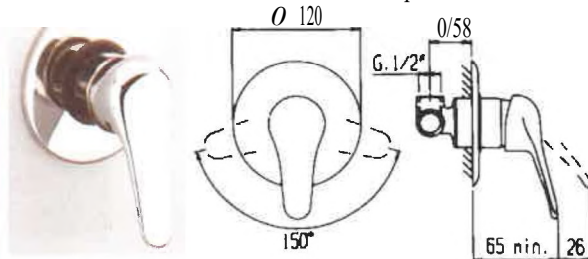

73505 MIX DOCCIA INC PUNTA CR SOL Art. 11276-002 P/C.1

**SOLP**  
NETTERIA

**SOLO**  
RUBINETTERIA







Miscelatore esterno per vasca con supporto duplex, flessibile cm. 150 e doccia.

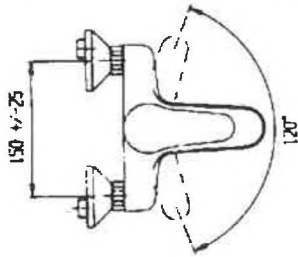

**73852** MIX VASCA C/DUPL PRIMA CR SOL Art. 13168-002C P/C.1



Miscelatore da incasso per doccia. Con cartuccia normale Globo.

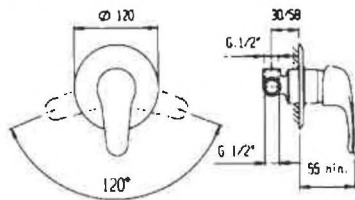

**73856** MIX INCASSO DOCC PRIMA CR SOL Art. 13268-001 C P/C.1



Miscelatore da incasso per doccia. Con bilanciatore di pressione. Con cartuccia normale Globo.

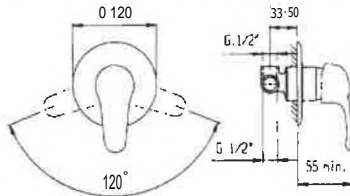

**73855** MIX INC DOC C/BIL PRIMA CR soL Art. 13268-101 C P/C.1



Miscelatore monoforo per lavello, con bocca girevole, leva laterale.

**73858** MDC LEVEL MONOF PRIMA CR SOL Art. 13568-003C P/C.1

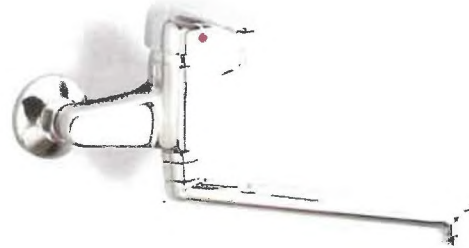

Miscelatore a parete per lavello, bocca lusso girevole.

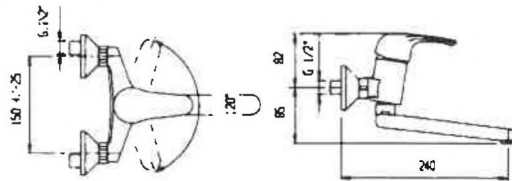

**73859** MIX LEVEL.PARETE PRIMA CRO soL Art. 13568-001-C P/C.1

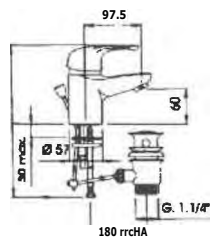

Miscelatore per lavabo, con &Darlo° automatico 1.1/4\"

- C Cromato
- NE Bianco

**73861 MIX LAVABO C/S PRIMA BIA** SOL Art. 13368-001NE/P/C.1

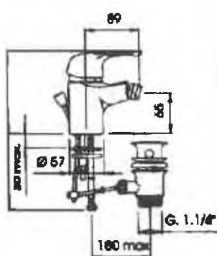

Miscelatore per Met, con scartacci automatico

- C Cromato
- NE Bianco

**73862 MIX BIDET C/S PRIMA BIA** SOL Art. 13468-001NE/P/C.1

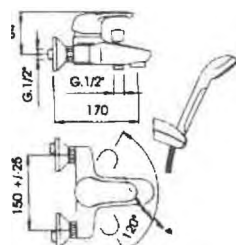

Gruppo miscelatore esterno per vasca col deviatore automatico . supporto duplex flessibile cm. 150. boccia .

- C Cromato
- DC Cromo - Oro
- NE Bianco
- LINE Bronco • orolux

**73863 MIX VASCA C/DUPL PRIMA BIA** SOL Art. 13168-002NE/P/C.1

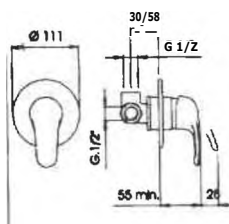

Miscelatore da incasso per doccia, con cartuccia Globo a benne-latore di pressione 'noie Con cartuccia Globo normale.

- C Cromato
- DC Correo - ordux
- NE filanoo
- D•El Banco

**73864 MIX INCASSO DOCC PRIMA BIA.** SOL Art. 13268-001NE

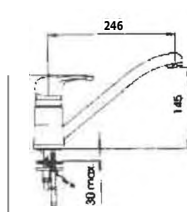

Miscelatore monotono per rovetto. Oocco glietole.

- C Cromato
- Grondo
- IZ Nera IZTA
- BAC010.3 la <A f lurido

**73866 M/XLAVEL MONOF PRIMA BIA** SOL Art. 13568-002NE/P/Cj

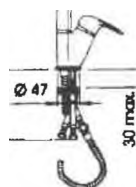

Miscelatore monofora per lavello.doccetta estraibile, due getti. leva laterale

- C cromato
- NE Bianco

**73867 MIX LAV MON D/ES PRIMA BIA SOL** Art. 13568-004NE/P/C.1







Miscelatore da incasso per doccia.  
Con bilanciatore di pressione.

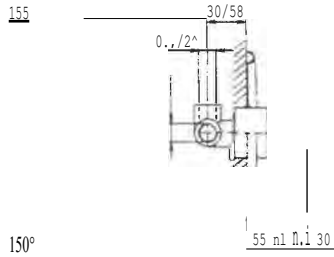

**73875 MIX INCAS DOCCIA BRAVA CR sol\_** Art. 12267-101 P/C.1



0321 5  
Miscelatore monoforo per lavello,  
bocca girevole.

**73879 MIX LAVELLO BRAVA B/GIR.CR sol\_** Art. 12567-002.C P/C.1



Miscelatore a parete per lavello,  
bocca lusso girevole.

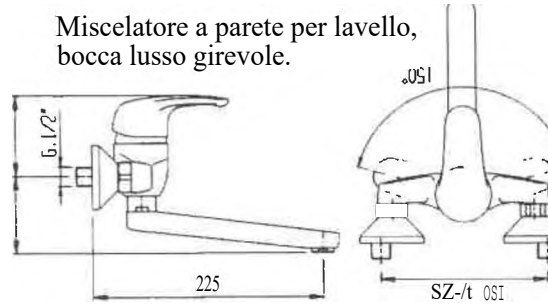

**73824 M/XLAVELLO PARETE BRADA soi\_** Art. 12567-001 P/C.1

*Smart*



**73891 A/LIX LAVABO 1.1/4 SMART CR** sen.. Art. 02362R001-CP/C.1

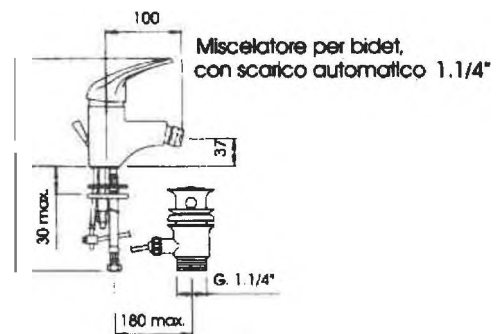

**73892 MIX BIDET 1.1/4 SMART CR** soi\_ Art. 02462R001-CP/C.1



Gruppo miscelatore esterno per vasca con deviatore automatico . supporto fisso , flessibile cm. 150 e doccia cromata.

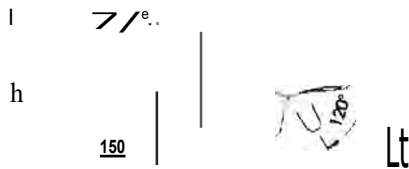

73893 MIX VASCA C/D SMART CR scm Art. 02162R010.C



Miscelatore esterno per (taccia, senza flessibile e doccetta, uscita inferiore da 1/2",

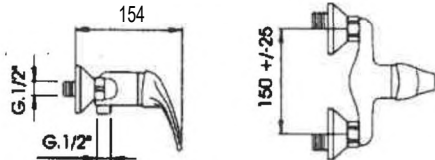

73896 MIX EST DOCCIA SMART CR sa Art. 02262A002-C P/C.1



Miscelatore da Incasso per doccia.

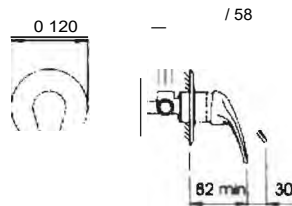

73895 MIX INC DOCCIA SMART CR sa Art. 02262R001-C P/C.1



Miscelatore monoforo per lavello, bocca girevole. 230

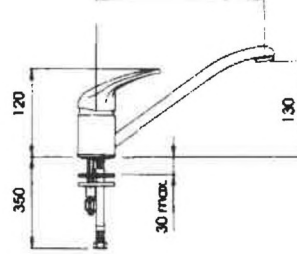

73898 MIKLAVEL MON B/GI SMART C sol Art. 02562R001-CP/C.1



150

Miscelatore monoforo per lavello, con canna lato 180 mm. leva laterale.

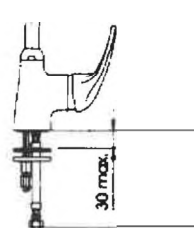

73899 MIX LAVEL MON B/LA SMART C soi Art. 02562R003-CP/C.1

4,

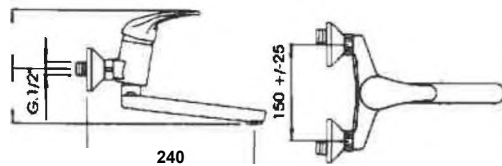

Miscelatore a parete per lavello, bocca girevole.

73897 MIX LAVELLO PAR SMART CR sol Art. 02562R002-CP/C.1



**Talento**

14/dscelatore per lavabo.  
con scolo° outomolico  
1.1/4".

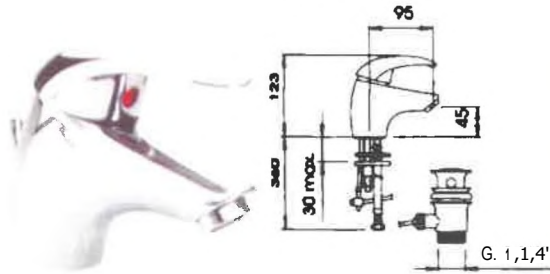

**73834 MIX LAVABO TALENTO CR** SOL Art. 14358-001 P/C.1



Miscelatore esterno per vasca senza dotazione.

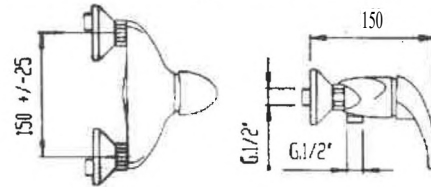

**73838 MIX EST DOCCIA TALENTO CR SOL** Art. 14258.002 P/C.1

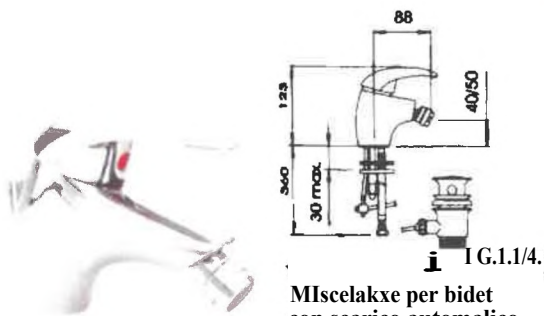

Miscelakxe per bidet  
con scarico automatico  
1.1/4'

**73835 MIX BIDET TALENTO CR** SOL Art. 14458-001 P/C.1

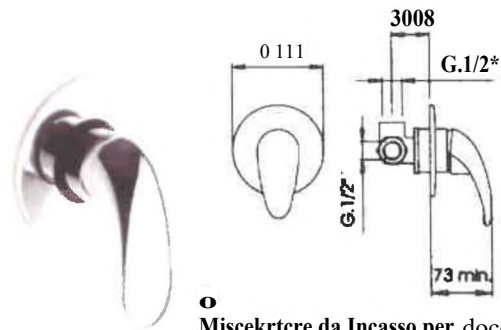

Miscekrtrre da Incasso per doccia, con  
cartuccia Godo normale.

**73837 MDC DOCCIA INC TALENTO CR** SOL Art. 14258-001 P/C.1



Miscelatore esterno per vasca con supporto  
duplex, flessibile cm. 50 e doccia.

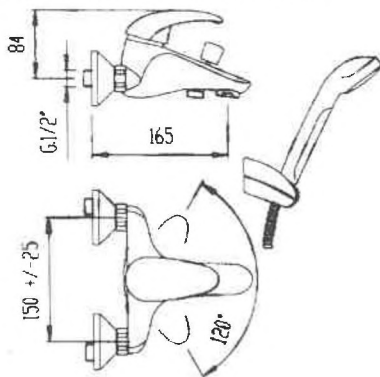

**73836 MIX VASCA C/D TALENTO CR** SOL Art. 14158.002 P/C.1

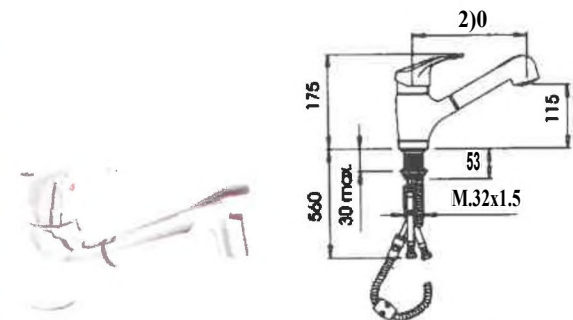

Miscelatore monoforo per  
lavello, doccetta  
estrattile, due getti.

**73822 MIX MON LAVEL D/ESTR DOMUS** soL Art. 03597-024 P/C.1

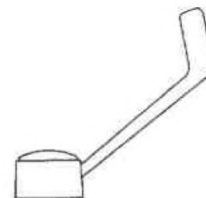

leva clinica adatta per miscelata) Fonte, Brava.  
Domus, completa di vite e placchetta.  
Confezionato In siin,  
C Cromato

**73571 LEVA LUNGA C/PLAC x DOMUS** soL Art. 67014.C P/C.1





Cartuccia ceramica per miscelatori sede Domus.  
Produzione precedente al 1993

73582 *CARTUCCIA CER x MIX DOMUS* SOL Art. 67013-C P/C.1

**Miscelatori  
Termostatici**



Miscelatore termostatico esterno per doccia,  
senza flessibile e doccetta, uscita inferiore da  
1 1/2".

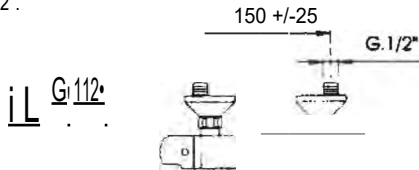

73544 *MIX DOCCIA EST TERMECH CR* SOL Art. 01225-011 P/C

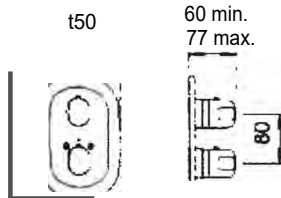

Solo parti esterne  
Miscelatore termostatico da incasso 3/4" con  
rubinetto regolatore di portata.  
(1 funzione).

73541 *SET PARTI EST x TERMOS INC* SOL Art. 06725-101C P/C.1

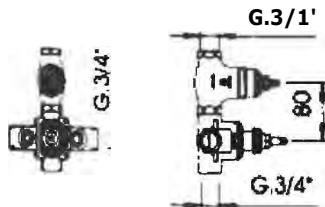

Solo corpo incasso  
Miscelatore termostatico da incasso 3/4" con  
rubinetto regolatore di portata.  
(1 funzione).

73542 *CORPO INCASSO MIX TERMOST* SOL Art. 01200-101-3 P/C.1



Miscelatore termostatico esterno per doccia,  
senza flessibile e doccetta, uscita inferiore da  
1 1/2", Interasse 150 mm.

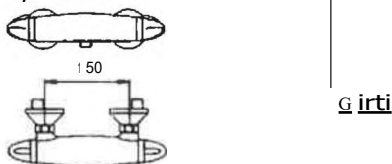

73547 *MDC EST TERMZEPPELIN CR* SOL Art. 15227-001 P/C.1

**Accessori**

**Flessibili per monoforo inox**

F3/8 x  
maschio corto cr 35

73577 *FLESS INDX F3/8xM8x1 CM35* COT Art. 030 790 035 P/C.1

g z0  
p n —A-Coppia crttocchini con dado 3 16" F 0 I Oxl  
"lunghezza mm.360.  
Confezionato In blisier  
c Cromato

360

73576 *COPPIA FLEX 3/8F 10X1 BLIS* sa. Art. 67020-C P/C.1

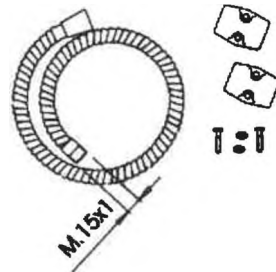

Confezione fissabile doppia oggrOffatura e  
contrappeso per lave@ doccia esimilo!>.  
Confezionato In blisier.  
C Cromato

73581 *FLESS C/PIOMBO x DOC/ESTR SOL* Art. 67233-C P/C.1



Nuore °s'amico 180° attacco 1/2",  
Confezionato in scatola da 6 pz.  
**Per serie RIVA, MEDEA e CROCE**

73572 *VITONE CERAMICO 180° MEDEA* sol\_ Art. 67120-C P/C.1



Ccolucda ceramica Globo unificato con  
blioncialore d pressione e Imilalore d  
temperatura e d palato. Confezionato In mar.  
**Per serie BRAVA**

73570 *CARTUCCIA CER/GLOBO C/BIL SOL* Art. 67257-C P/C.1

**SOLO**  
RUBINETTERIA



Cartuccia ceramica Globo unificata con l'imitatore di temperatura e di portata, con adattatore universale e ghiera di bloccaggio.

**UNIVERSALE**

rt=r23

73583 CARTUCCIA CERIGLOBO C/GHI su Art. 67400-C P/C.1

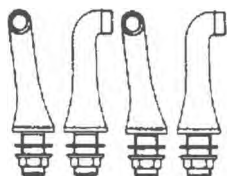

Coppia raccordi colonna per montaggio gruppo sul bordo vasca, interasse da mm.150 o mm.180 altezza mm.125.

Confezionato in scatola,

73584 COP RACC. COLON x GR B/VAS son Art. 66223-C P/C.1

**Croce**



**Batteria per LAVABO.  
Con bocca Artis  
e scarico automatico 1.1/4".**

**Disponibile in colore CROMATO**

73513 GR LAVA.3F B/BAS CROCE CR soL Art. 04340-080 P/C.1



**Batteria per LAVABO.  
Bocca fusa.  
Con scarico automatico 1.1/4".**

**Disponibile in colore CROMATO**

73520 GR LAVA.3F FUSA CROCE CR su\_ Art. 04340-100C P/C.1

**Batteria per LAVABO.  
Con collo girevole  
e scarico automatico 1.1/4".**

**Disponibile in colore CROMATO**

73514 GR.LAVA.3F B/ALT.CROCE CR SOL Art. 04340.004 P/C.1

r.

**Batteria per LAVABO.  
Con bocca Artis  
e scarico automatico 1.1/4".**

**Disponibile in colore CROMATO**

73519 GR LAVA. MONOE CROCE CR sa\_ Art. 04340-006c P/C.1



**Gruppo monoforo tipo PESANTE  
per LAVABO. Con bocca girevole  
e scarico automatico 1.1/4".**

**Disponibile in colore CROMATO**

73512 GR LAVA.PES.TE MF CROCE CR son Art. 04340-088 P/C.1



**Completo per BIDET  
con scarico automatico 1.1/4".**

**Disponibile in colore CROMATO**

73515 GR BIDET C/S CROCE CR su.. Art. 04440-002 P/C.1





*Gruppo monoforo per BIDEI,  
con aeratore orientabile e  
scarico automatico 1.1/4".*

*Disponibile in colore CROMATO*

73511 GR BIDEI MF C/SAL CROCE CR SOL Art. 04440-006P/C.1



*Gruppo lusso esterno per VASCA.  
Con Doccia. Flessibile cm 120.  
Interasse mm 160.  
con scarico automatico 1.1/4".*

*Disponibile in colore CROMATO*

73516 GR VASCA C/DUPLEX CROCE CR SOL Art. 04140.002 P/C.1



*Gruppo monoforo per lavello,  
bocca fusa girevole mm 180.*

*Disponibile in colore CROMATO*

73521 GR LAVELLO MONOF CROCE CR SOL Art. 04540-0320 P/C.1



*Gruppo lusso a parete per LAVELLO.  
Interasse mm 160*

*Disponibile in colore CROMATO*

73529 GR. LAVEL PARETE CROCE CR SOL Alt 04540-0010 P/C.1



*Coppia rubinetti da incasso diritto,  
attacco da 1/2",  
placchetta "CALDA" e "Fredda".*

*Disponibile in colore CROMATO*

73522 RUBINETTO INC 1/2 CROCE CR SOL Art. 04140-006 P/C.1

**Riva**



**serie RIVA**

**Batteria LAVABO,  
con scarico automatico 1.1/4".**

**Disponibile in colore CROMATO**

73558 GR LAVABO C/SI.1/4 RIVA CR SOL Art. 06328-106 P/C.1



**serie RIVA**

**Batteria LAVABO  
testa cieca.**

**Disponibile in colore CROMATO**

73559 GR LAVABO S/SALT. RIVA CR SOL Art. 06328-107 P/C.1



### serie RIVA

**Completo per BIDEI  
con scarico automatico da 1.1/4".  
Rubinetti "rosso" e "blu".**

**Disponibile in colore CROMATO**

73560 GR BIDEI C/S 1.1/4 RIVA CR SOL Art. 06428-038 PIC.1

ee'75



O<sup>e</sup> ca.110è

### serie RIVA

**Coppia rubinetti per BIDEI.  
Colore "rosso" e "blu".**

**Disponibile in colore CROMATO**

73561 RUBINETTO BIDEI RIVA CR SOL Art. 06428-039 P/C.2



### serie RIVA

**Miscelatore monoforo per LAVABO,  
con scarico automatico 1.1/4".**

**Disponibile in colore CROMATO**

73557 GR LAVABO MONOF RIVA CR son Art. 06328-108 P/C.1



### serie RIVA

**Gruppo monoforo per BIDEI,  
con scarico automatico 1.1/4".  
Getto orientabile.**

**Disponibile in colore CROMATO**

73569 GR BIDEI MONOF RIVA CR SOL Art. 06428-040 PIC.1



### serie RIVA

**Gruppo esterno per VASCA,  
doccia con flessibile cm 150,  
interasse mm 150.**

**Disponibile in colore CROMATO**

73562 GR VASCA C/D RIVA CR SOL Art. 06128-044 P/C.1



**Gruppo esterno per doccia, attacco da 1  
inferiore, senza flessibile e doccetta,  
interasse mm.150.**

150 +/-25



c)1;c9  
b)...



73563 GR ESTERNO DOCCIA RIVA CR SOL Art. 06228-016 P/C.1



Bocca inferiore a "S" mm. 180 con aeratore.  
Confezionato in sidn.

73555 BOCCA EROGAZ x GR LAV RIVA SOL Art. 67076-C P/C.1



### serie RIVA

**Gruppo monoforo per LAVELLO,  
canna jota mm 150.**

**Disponibile in colore CROMATO**

73566 GR LAVELLO MONOF RIVA CR son Art. 06528-125 PIC.1



**serie RIVA**  
**Gruppo a parete**  
**per LAVELLO**

**Disponibile in colore CROMATO**

**73565 GR LAVELLO MURO RIVA CR** SOI\_ Art. 06528.124 P/C.1

ar'

**Coppia rubinetti da Incasso da 1/2", rosone scorrevole, con indice blu e rosso.**

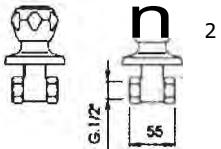

**73567 RUBINETTO INC RIVA 1/2 CR** SOL Art. 06128-046 P/C.1



Prolunghe mm.20  
 per vitone rubinetti incasso.  
 Confezionato in skin.

**73573 PROLUNGA x RUBINET INCASSO** SOL Art. 67111 .C P/C.

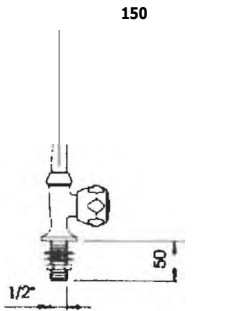

Rubinetto colonna per lavello con aeratore.

**73568 RUB COLONNINA BAR RIVA CR son** Art. 06528.200 P/C.1



Vitone attacco 1/2" broccia 8x20.  
 Confezionato in scatola da 6 pz

**73553 VITONE x SERIE RIVA 1/2** SOL Art. 67119 P/C.1

**Rubinetti Lavello**



A  
 al

**Monoforo Lavello**  
**con Canna Tubo**  
**Girevole**

**71408 GRUPPO MONOF LAVELLO SOLE EDR** Art. 602 P/C.1



**70187 RUBIN SNODO C/ATT LAV 3/8** Cui Art. 308.00001 P/C.12

**71409 RUB SNODO ATT LAV 1/2** EDR Art 4034-613 P/C.5



**Gruppo lavello**  
**con Canna Inferiore**

**72809 GRUPPO LAVELLO NORMALE** EDR Art. 600 P/C.1



**72810 RUBINET.LAVABO C/CIGNO 1/2** EDR Art. 628 P/C.



**72808 GR LAVEL PAR CANNA/SUP CRO** EDR Art. 600/U P/C.1



Rubinetto per krieki kromina (dupiek).  
corpo fuso 1/7.  
Confeziona da 2 pezzi.

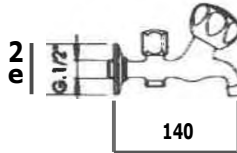

73886 RUB.LAVEL DUPLEX MAK/MA CR sot. Art. 06506-036 P/C.2

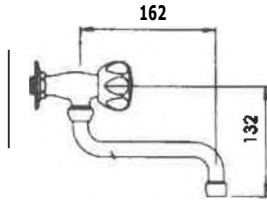

Rubinetto a snodo film  
~orde da 1/2 per  
icroalb con aeratore.  
Confeziona da 4 pz.

73887 RUB.SNODO LAVEL MAX CR 1/2 sol\_ M. 06506-075 P/C.4

Maxima

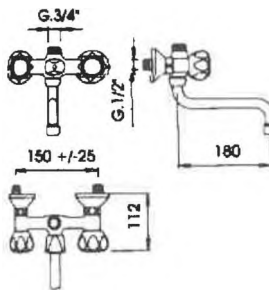

Gruppo a parete per lovero  
canna girevole con  
attacco lavatrice 314",  
Interasse mm.150, canna  
girevole inferiore mm.  
180, con arectore.

73883 GR LAVILAVAT P,4R MAMMA CR soi\_ Art 06506.073P/C.1

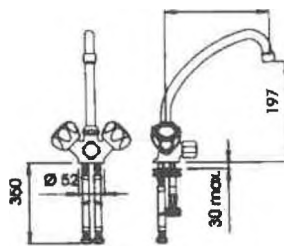

Monofo per icrvello con  
aeratore, con deviatore  
per lavaskivlgie.

73888 GR MON LAV/LAVAT MAXIMA CR SOL Art. 06506-052 Mi

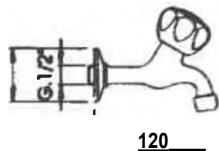

Rubineflo incinoro per levelti  
colpo fuso do 11/7,  
con met:don  
Confeziona do 4 pezzi

73595 RUB.INCL.LAVEL MAN.MAXIMA soi\_ Art. 06506-32 P/C.4

0 55

Scarico automatico  
per bidet da 1 114".

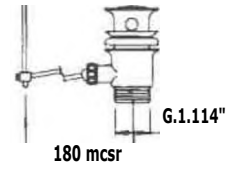

73889 SCARIC AUT BIDET MAXIMA CR SOL Art. 06400-013 P/C.1

Rubinetteria Bonomi  
Como

bémomi

Miscelatore monocomando per lavabo con cartuccia  
0 35 con scarico automatico da I" 114.

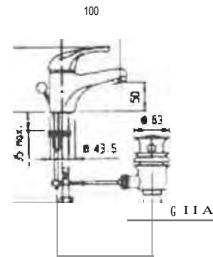

72730 MIX LAVABO COMO I CRO MPB Art. 4104/E P/C.1



Miscelatore monocomando per bidet con  
cartuccia 0 35 con scarico automatico da I" 1/4.

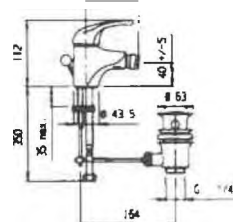

72731 MIX BIDET COMO I CRO MPB Art. 4204/E P/C.1



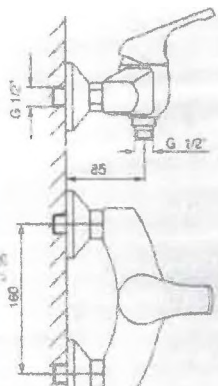

**72764** MIX EST DOCCIA VERONA CRO MPB Art. 22500 P/C. 1



110

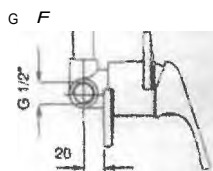

**72763** MIX DOCCIA INC VERONA CRO MPB Art. 22032 P/C. 1

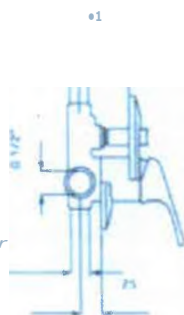

**72769** MIX DOC INC C/DEV VERON CR MPB Art. 22034 P/C. 1

**W.0RU**  
bónomi



**72765** MIXLAVELIFC/ALT VERONA CR MPB Art. 25500 P/C. 1

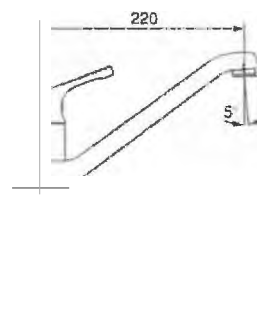

**72766** MIX LAVEL MON VERONA CROM MPB Art. 25000 P/C. 1

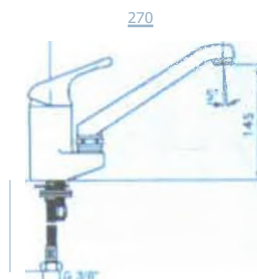

**72771** MIXLAV MON B/SPOS VERO CR MPB Art. 25001 P/C. 1

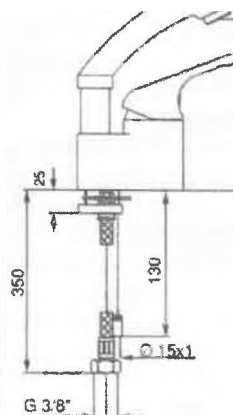

**72768** MIXMONPARRUCCH. VERONA MPB Art. 23036 P/C. 1



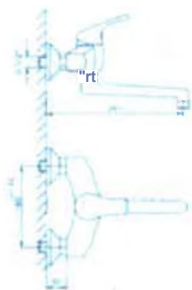

**72767 MIX LAVEL A MURO VERONA CR** MPB Art. 25030 P/C. 1

Rad

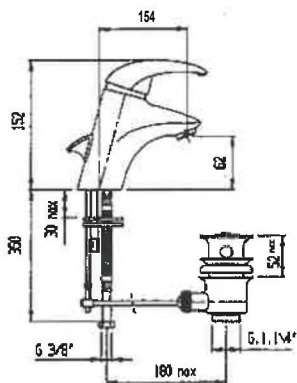

**72722 MIX LAVABO BARI CRO** MPB Art. 3130/E P/C.1

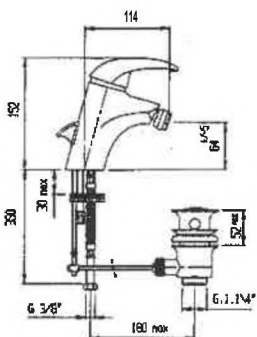

**72723 MIX BIDET BARI CRO** MPB Art. 3230/E P/C.1

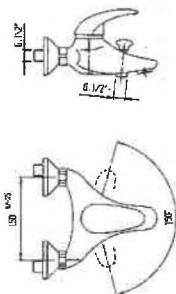

**72725 MIX VASCA C/DOC. BARI CRO** MPB Art. 3330 P/C. 1

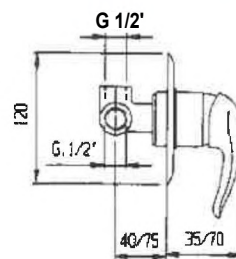

**72724 AffIC DOCCLA INC. BARI CRO** MPB Art. 3530 P/C. 1

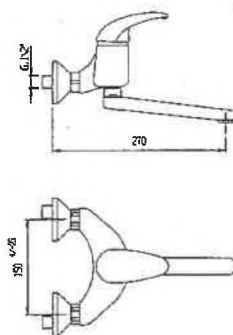
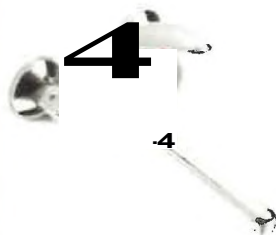

**72726 MIX DOCCIA EST. BARI CRO** MPB Art. 3430 P/C. 1

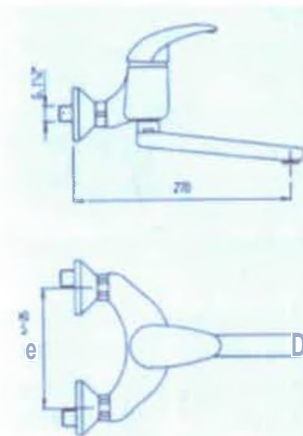

**72727 MIX LAVEL.MURO BARI CRO** MPB Art. 3630 P/C. 1

Accessori



**Resile per doccia ( )stradale**  
Lungheriza: 120 cm.

**72779 FLESS x MIX LAVEL MEG 150** MPB Art. KFX15CR P/C. 1





72865 VALVOLA DEVIATR x GR VASCA MPB Art. 2300/229A P/C.1



Deviatore per miscelatori serie VERONA (Versus)

72796 DEVIATORE x BONOM/VERS CRO MPB Art. 62320/49B P/C.1



Canna fusa pesante per lavello serie TRADIZIONALE

72844 CANNA FUSA PESANTE LAVELLO MPB Art. 5064 P/C.1

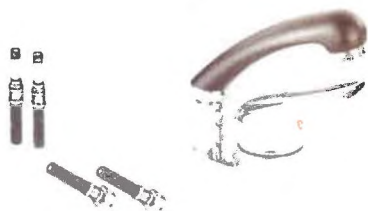

Coppia flessibili prolungati per miscelatore parrucchiere monoforo  
Lunghezza: 35 cm  
Attacco: 3/8° F

72902 AITACCHIN PROLUNGATO x MIX MPB Art. 25000/2 P/C.1



72778 DOCCIA STUDIO x MEGAMIX CR MPB Art. 010050CR P/C.1

**C Rh**  
**bònomi**  
Rubinetteria d'Italia dal 1905

Leva per rubinetteria serie VERONA

72788 LEVA VERONA MPB Art. 22032/19A P/C.1



Leva lunga dritta per rubinetteria serie VERONA

72790 LEVA CLINICA VERONA DRITTA MPB Art. 25038/1 P/C.1



Leva lunga inclinata per rubinetteria serie VERONA

72793 LEVA CLINICA VERONA INCLIN MPB Art. 23011/19A P/C.10



Cartuccia (Modello vecchio)

72798 CARTUCCIA X BONOMLX MPB Art. 80001 P/C.10



Cartuccia (Modello nuovo)

72799 CARTUCCIA X VERONA GRIGIA MPB Art. 70000 P/C.1

Cartuccia ceramica o 40 mm

50002 - per serie BARI (ex Australia)

50003 - per serie VERONA (ex Versus)  
per miscelatori ad incasso  
e con canna girevole BARI

72791 CARTUCCIA §40 AUST-BARI MPB Art. 50002

72797 CARTUCCIA §40 VER MPB Art. 50003

Cartuccia ceramica o 35 mm

OICTO3 - per serie COMO (ex Africa)

OICTO4 - per miscelatori ad incasso  
e con canna girevole COMO

72792 CARTUCCIA §35 AFRIC-COMO MPB Art. 01 CTO3

72801 CARTUCCIA §35 AFRIC-COMO MPB Art. 01CTO4







Canna a "U"  
per lavello  
serie **TRADIZIONALE**

72845 CANNA LAVELLO A U PER 5045 MPB Art. 5065 P/C.1



Canna a "elle"  
per lavello  
serie **TRADIZIONALE**

72843 CANNA A ELLE PER 5005 MPB Art 5061 P/C.1



72899 VITONE MPB P/C.1



Coppia guarnizioni  
per miscelatore lavallo monoloro  
serie **ROMA**

72795 COPPIA GUARNIZIONE x 75000 MPB Art. GU65000/6-7 P/C.1



Flessibile in ottone  
Lunghezza: 150 cm

72900 FLESSIBILE 1.50 m OTTONE MPB Art. OT2560C150 P/C.1



72014 CARTUCCIA X MISCELATORE HAN Art. 904601 P/C.1

Rubinetteria Rapetti  
MK3

**RAPETTI**  
enjoy the quality.

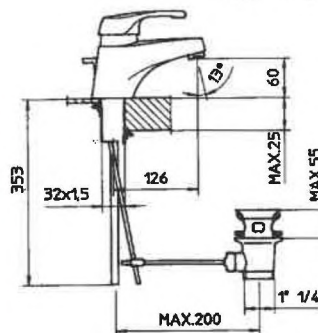

71156 MISC. LAVABO MK3 RAP Art. 9050142000 P/C.1

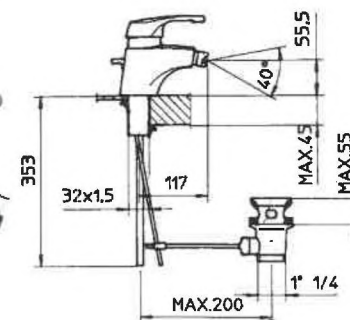

71157 MISC. BIDET MK3 RAP Art. 9100142000 P/C.1

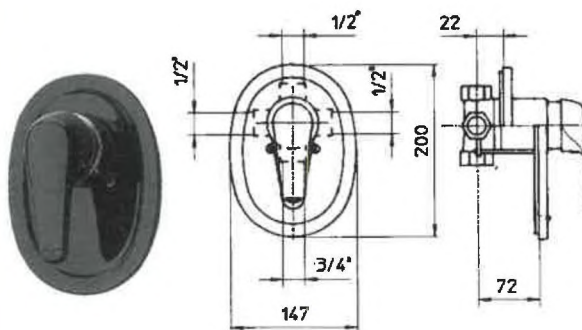

71159 MISC. DOCCIA MK3 RAP Art. 9150042000 P/C.1

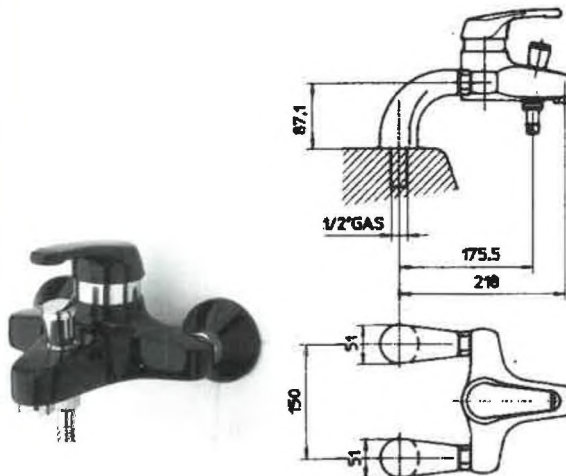

71158 MISC. VASCA ESTERNO MK3 RAP Art. 9250042000 P/C.1

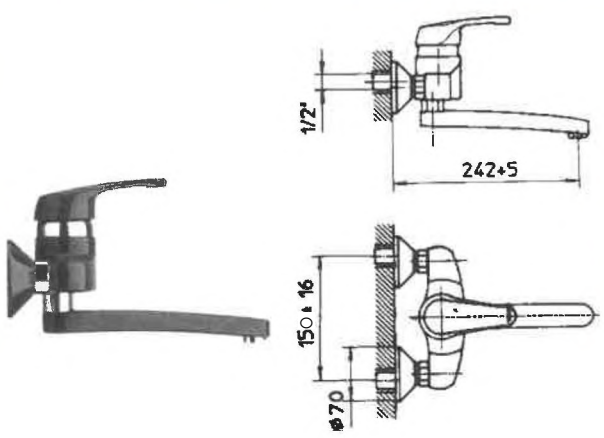

71137 MISCELATORE PARETE MK3 RAP Art. 9210142000 P/C.1

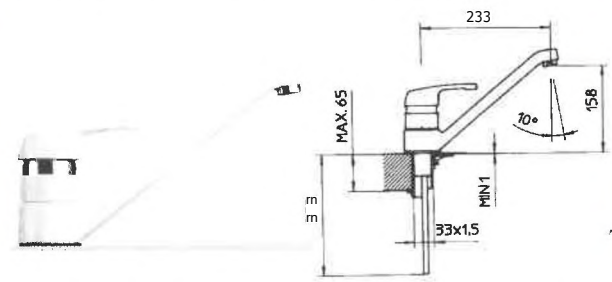

71155 MISC. MONOF LAVELLO MK3 RAP Art. 9401142000 P/C.1

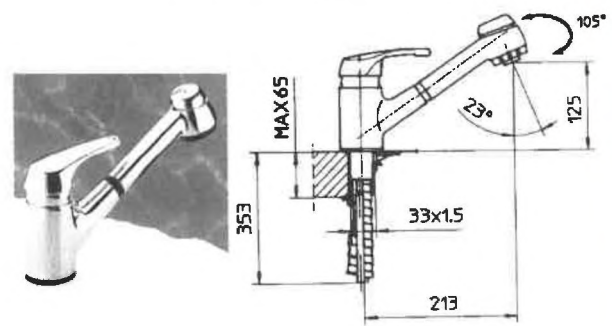

71139 MISC. LAV. DOCC/ESTR. MK3 RAP Art. 9222142000 P/C.1



Per tutti i modelli Rapetti

74256 CARTUCCIA x MK2 RAP Art 4890001000 P/C.1



74255 PROLUNGA x CARTUCCIA x MI< RAP Art. 0090395000 P/C.1



74257 MANIGLIA S/33 x MONOC. MK3 RAP Art. 0090465000 P/C.1

Garda

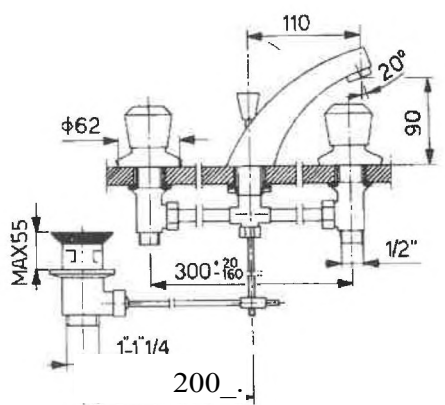
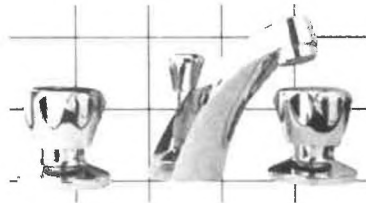

71201 BATTERIA LAV C/SALT. 1 T RAP Art. 8000000000 P/C.1

71202 BATTERIA LAV. S/SALT. T RAP Art. 8020100000 P/C.1

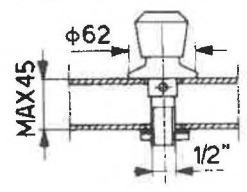

71203 RUBINETTO LAVABO 1/2 T RAP Art. 8030000000 PIC.1

71207 RUBINETTO BIDET 1/2 T RAP Art. 8200000000 PIC.1

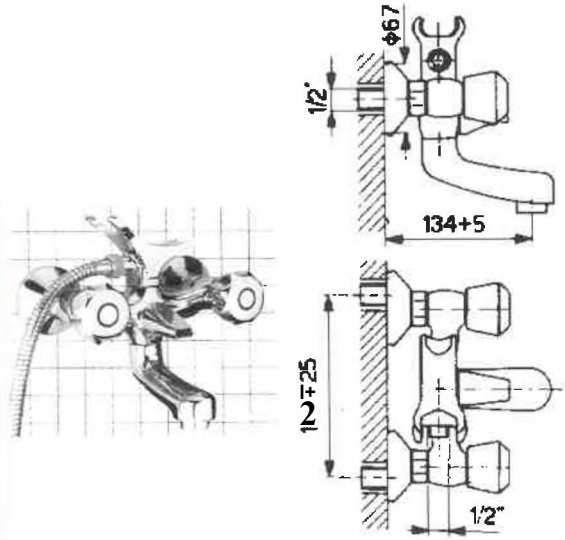

71208 GRUPPO VASCA C/DEV S/AC. TRAP Art. 8390800000 P/C.1

**RAPETTI**  
enjoy the quality.

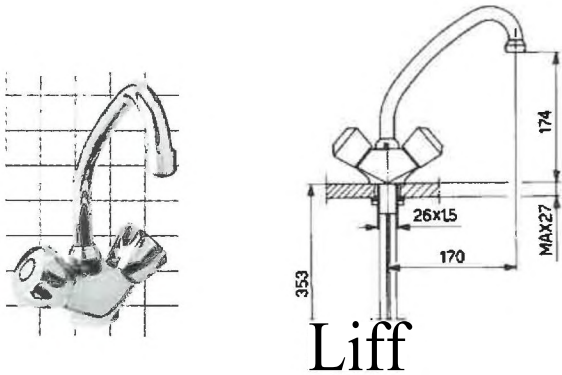

**Liff**

**71204 GRUPPO LAVELLO MONOFORO T** RAP Art. 8050700000 P/C.1

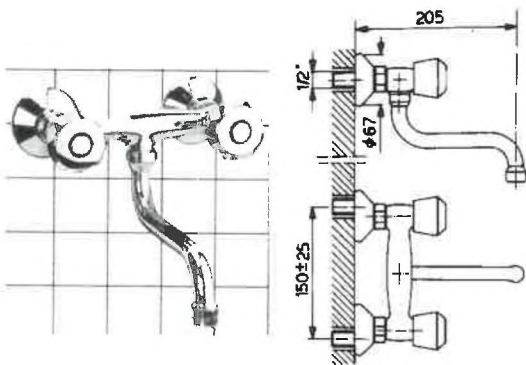

**71214 GRUPPO LAVELLO A MURO T** RAP Art. 6610700000 P/C.1

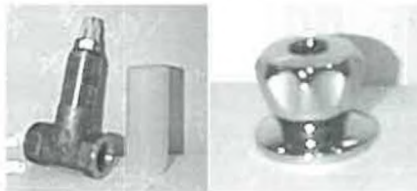

**71210 RUBINETTO INC. DIR. 1/2 T** RAP Art. 8320000000 P/C.1

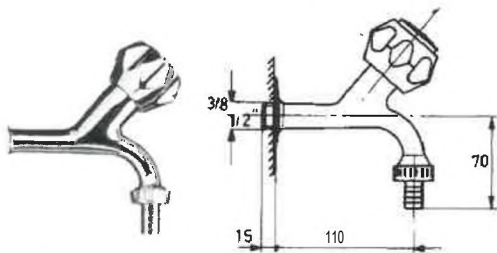

**72817 RUBIN:PORT/GOMMA 1/2 MURO** RAP Art. 8840000000 P/C.1



**72800 PONTE DOCCIA 1/2** MAV Art. 02107 P/C.1

**Accessori**



**74237 AERATORE Mx BOCHE LAVABO** RAP Art. 0090056000 P/C.1

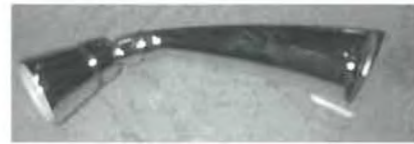

**71219 DOCCIA SNI/2** RAP Art. 4150001000 P/C.1



**Prolunghe**

**74204 GRANO 10 mm x PROL. RUBIN.** RAP Art. 0003040000 P/C.1

**74200 GRANO 15 mm x PROL. RUBIN.** RAP Art. 0002290000 P/C.1

**74205 VITE 58 mm x GRANI PROL.** RAP Art. 0003340000 P/C.1



**74202 SEDE x RUBIN. BIDE T** RAP Art. 0000160000 P/C.1



**74208 SEDE x RUBIN. LAVABO** RAP Art. 0006061000 P/C.1



**74203 SEDE x RUBIN. INCASSO** RAP Art. 0001251000 P/C.1



**74263 SEDE C/CALOTTA 3/4** RAP Art. 0090921000 P/C.1

**RAPE'TTI**  
eilloY the qusditY-

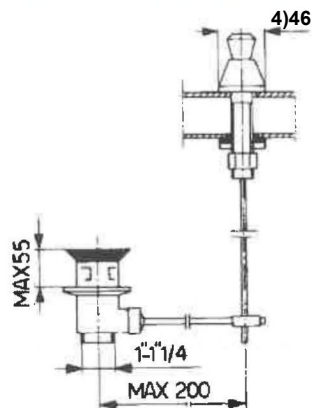

**71216 SCARICO BIDET I** RAP Art. 8220001000 P/C.1

**71217 SCARICO BIDET L I/4** RAP Art. 8230001000 P/C.1



**74209 VITE FISSAGGIO VOLANTINO** RAP Art. 0001171000 P/C.1



**74264 VITONE UNIFICATO** RAP Art. 0090951494 P/C.1



**74214 INSERTO x VITONE** RAP Art. 0006531000 P/C.1



**74215 ANELLO ANTIFRIZ E GUARNIZ** RAP Art. coguleocio P/C.1

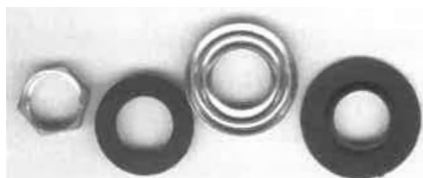

**74243 CONE. GUARN. RUBIN. LAV.** RAP Art. 0090295000 P/C.1



**74219 GUARNIZ x SEDE RUB. INC.** RAP Art. 0020110000 P/C.1



**74265 FLESSIBILE x PARRUCC 120cm** RAP Art. 4660001000 P/C.1



*In plastica*

**74233 ROMPIGICCO x BOCCA LAVABO** RAP Art. 00902000 P/C.20

*In plastica*

**74234 ROMPIGETTO x BOCCA IN TUBO** RAP Art. 0090035000 P/C.1



*In plastica*

**74235 ROMPIGETTO x BOCCA VASCA** RAP Art. 0090201000 P/C.1



**74236 AERATORE x BOCCA IN TUBO** RAP Art. 0090036000 P/C.1



**74239 INDICE BLU-ROSSO X TONDA** RAP Art. 0090200000 P/C.1



**74206 MANIGLIA GARDA** RAP Art. 000820000 P/C.1



**74207 VOLANTINO S/TONDA** RAP Art. 009012000 P/C.1

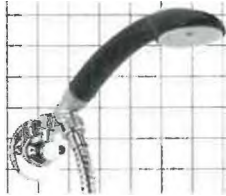

**71212 DOCCIA TANGA C/FLEX CR 120** RAP Art. 2350501000 P/C.1



**74249 DOCCIA NYLON BIANCA TANGA** RAP Art. 00907390 P/C.1

**Miscelatori Cusiomix X  
Sostituzioni Rubinetti Incassati**



**76218 MIX CUSIO x LAVABO MON CR** DTA Art. 701140 S200 P/C.1



**76219 MfX CUSIO x BIDET MON CR** DTA Art. 701150 5205 P/C.1



**Permette la sostituzione del miscelatore  
nella sede di un precedente rubinetto.**

**76216 MIX CUSIO EST.X DOCCIA CR** DTA Art. 701010 S100 P/C.1



**Permette la sostituzione del miscelatore  
nella sede di un precedente rubinetto.**

**76217 MIX CUSIO x VASCA C/SET CR** DTA Art. 701050 S110 P/C.1



**76220 VITONE x CUSIO INC.DOC 5/8** DTA Art. AI 0932T-701184 P/C.1

**Accessori**



**Guarnizioni per lavello cod. 72006**

**72031 O-RING § 47.22 x 3.53** HAN Art. 904891 P/C.1

**Rubinetto Pedale**



**71522 RUBINETTO PEDALE A PAVIM** RVR Art. R501 283P/C.1



**71521 MIX PEDALEPAVIMENTO 1 PED** RVR Art. R510 283P/C.1

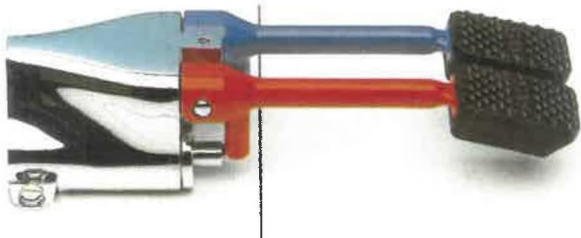

Esterno. Per il fissaggio a pavimento (ideale per impianti già esistenti).  
 Un pedale per acqua calda e uno per acqua fredda.  
 Premendo contemporaneamente i due pedali si ottiene una buona miscelazione.  
 Corpo in ottone lucidato e cromato.  
 Completo di lusselli ad espansione e viti. Portata costante.  
 Lunghezza della leva mm.150. Ingombro totale mm.225.  
 Attacchi da **VI** femmina.

**71523 MIX PEDALE PAVIMENTO 2 PED** RVR Art. R550 283P/C.1



**Miscelatore a parete con comando a pedale**  
 Esterno. Regolatore di portata incorporato.  
 Corpo in ottone lucidato e cromato.  
 Completo di accessori per il montaggio.  
 Attacchi da 1/2" F.

**71527 RUBINETTO PEDALE A PARETE** RVR Art. R502 283P/C.1



**71528 MIX PEDALE PARETE** RVR Art. R520 283 P/C.1



*Possibilità di stringere fino a 40 mm di spessore*

**71524 BOCCA ORIENTABILE LAVABO** RVR Art. R590 283P/C.1



**71525 BOCCA EROGAZ PARETE SNODO** RVR Art. R591 283P/C.1

*Rubinetti Temponzati*



**R 703 - Comando a pulsante con bocca orientabile**

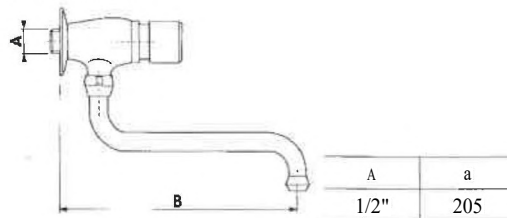

**71612 RUBINETTO TEMPOR BOCBAS.** RVR Art. R 703 PIC.1



**R 710 - Comando a pulsante - nessuna regolazione per l'installazione - erogazione per circa 20 sec. di 7 l/m da 0,5 a 9 atm.**

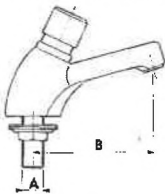

A	B
1/2"	115

71614 RUBINETTO TE/10°0R. LAVABO RVR Art. R 710 P/C. 1



**R 701 • Comanda a pulsante • nessuna regolazione per l'installazione • erogazione per circa 20 sec. di 7 l/m da 0,5 a 9 atm.**



1 ir I 50  
1/2" t 75

%height do SO\* 75 non

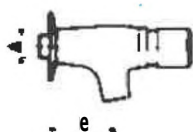

A e  
1/2" 40

71618 RUBIN TEMP C/PULSANTE 1/2 RVR Art. R 701 P/C. 1



**R 715 - Comando a pulsante - ruotando il pulsante si ottiene la miscelazione - completo di 2 rubinetti a squadra con Filtri inox e valvole di non ritorno -**

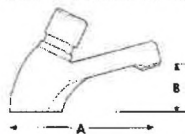

A	B
115	54

71615 MIX LAVABO TEMPORIZZATO RVR Art. R 715 P/C. 1



**R 730 - Rubinetto a squadra - comando a pulsante - nessuna regolazione per l'installazione - erogazione per circa 6 sec. di 7 l/m. da 0,5 a 9 bar**

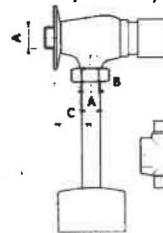

A	B	C
1/2"	014	34

**R 737 - Da incasso, attacchi F - caratteristiche come art. precedente**

71616 RUBIN X ORINATOIO TEMP. 1/2 RVR Art. R 730 P/C. 1

### Accessori Per Orinatoio E Turche

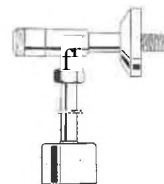

73012 RUBINETTO C/CAPP ORIN 3/8 TRE Art. 309 Pic. 1

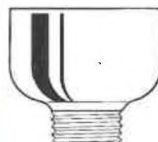

Attacco 1" filettato

73014 BICCHIERE x ORINATOIO \$55 TRE Art. 331 P/C. 1

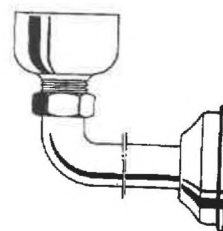

70903 CURVA ORINATOIO C/BICC RAF Art. 610 P/C. 1

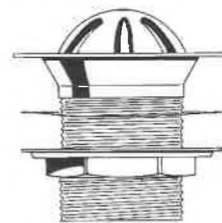

70906 PILETTA CUFFIA x ORIN \$65 RAF Art. 614 P/C. 1

70907 PILETTA CUFFIA x ORIN \$82 RAF Art. 614 P/C. 1



**70914 SPARTIACQUE FUNG ATT/POST** RAF Art. 624 P/C. 1



**70916 SPARTIACQUE FUNG ATT/VERT** RAF Art. 628 P/C. 1



**73015 SPARTIACQUE TURCA CURVO I** TRE Art. 324 P/C. 1



**73016 SPARTIACQUE TURCA DIR. I** TRE Art. 326 P/C. 1

**Rubinetti A Fotocellula**

114 x 350, 11 x 135  
Lungh. 3000 14 V.AC  
h G112  
79

- Alimentazione elettrica con trasformatore di sicurezza (IMQ) (220 V/15 V - 50 Hz oppure 120 V/15 V - 60 Hz)
- Sensori a 3 fotocelle con protezione antigraffio ed anttccalcare
- Circuito elettronico completamente resinato, con tecnologia a microprocessore
- Scocca in metallo antivandalismo
- Fissaggio antivandalismo
- 3 Valvole di non ritorno su rubinetti d'arresto con filtri
- Regolatore di portata d'acqua incorporato 16 Vmin
- Raggio d'azione dei sensori. 12 - 35 cm
- Circuito elettronico 12 V-DC
- Elettrovalvola 12 V-DC
- Pressione acqua 0,4 - 7 bar
- Attacchi idrici: 1/2 G

**72209 MIX L.B0 CLASS 20M EL 220V** DMP Art. 22203 P/C. 1



- Alimentazione elettrica (1114Q) (220 V/15 V - 50 Hz oppure 120 V/15 V - 60 Hz)
- Sensori a protezione antigraffio anttccalcare
- (, (1A, 10 elYtr(ol : : ) Clgreieta010 res nau y od e't
- Redifrdre di patate dai q,, 1, 1rlorporat Non i
- RAlilid d'anone dei sonse. <1 10 - 30 cm
- aettrdi, i 12V-DC
- Pressione 0,4 - 7 bar
- Azr<hit rdnn 1/2 G

**72210 MIX LAVABO FULL 20 EL. 220V** DMP Art. 02203 P/C. 1



- Alimentazione con 3 pile alcaline da 1,5 V - Size AA LR6 (4,5 V)
- (, (1, 1, JSSOIC ri W; +7 a1110+C t.x.e. reper ,, imingue
- Porata i anni per 10(1a, on"enti al
- leivoicidg a microproimsdro
- Si rdttd: LIIIH, Wdel. 1171(+
- i SSEL(V)O
- % 1LVrif d 1=011 1/M110 si, rilbmetU d'aesto (01' Stilt.OFF ILIFH (ai t, (dnSt, "'' il g...)
- n12 ;
- G 1 2
- c
- re
- 79
- IO 55<m
- 4.5 V
- 3v
- Pili, 111' .(1.1.1 0,4 - 7 bar
- All i, ili doe 111 G

**72204 RUB IN ELET.CLASS 20M BT ME** DMP Art. 82218 P/C.









**GRUPPO LAVELLO LEVA  
LUNGA A GOMITO CON  
ROMPIGETTO**

Misura Pz. per Conf.  
1/2 1

71407 GR.LAVELLO LEVE LUNGA MURO EDR Art. 670 P/C.1

**Bocche Di Erogazione**

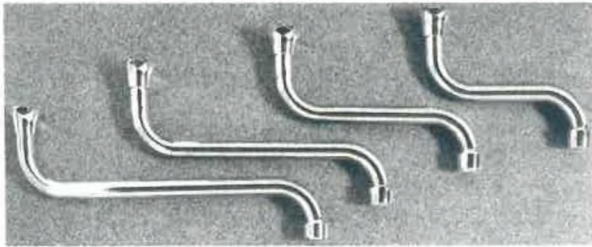

**BOCCH EROGAZIONE  
UNIVERSALI**

Canne universali per gruppi lavello,  
mm. 18, calotta 3/4", terminale  
Nettato 22/1, In ottone cromato.  
Lunghezza: 100/150/200/250/300 mm.  
Confezioni da 10 pezzi.

70190 BOCCA EROGAZIONE 30 cm MAV Art. 02563CM30 P/C.10

70191 BOCCA EROGAZIONE 25 cm CLB Art. 310-00025 P/C.10

70192 BOCCA EROGAZIONE 20 cm CLB Art. 310-00020 P/C.10



70185 BOCCA ROVES cm 30 x GR LAV MAV Art. 025643/4 CM P/C.1



**BOCCH EROGAZIONE  
UNIVERSALI**

Canne universali per gruppi mano foro,  
mm. 18, calotta 3/4", terminale  
filettato 22/1, in ottone cromato.  
Lunghezza canna: 170 mm. 41)

70193 BOCCA UNIVER. PER MONOE CLB Art. 310-00MON P/C.1

**Terminali Rompigetto  
Per Bocche Di Erogazione**



Attacco a stringere.

75927 CANNUCCIA C/MORS 15 CROM. IPR Art. 910/15G P/C. 1



Attacco filettato  
maschio o femmina  
Diametro 1,5.

75932 SNODO C/DOCCETTA E AERAT. IPR Art. 914 P/C. 1



75935 CANNUCCIA E AERATORE 15 IPR Art. 912/15P/C. 1

Tubetti Cromati Di '10 Raccordati

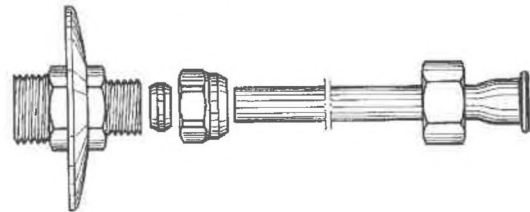

**TUBO RAME CROMATO Diam.  
10 CON CARTELLA, NIPLO DA**

**1/2 x 10 E ROSONE**

Lungh. cm Pz. per Conf.

30	25
35	25
50	25
100	10

75212 AITAC LISCIO § 10 1/2x30 EDR Art. ART.407 P/C.20

75216 ATTAC. USCIO § 10 1/2x50 EDR Art. ART.407 P/C.20

75218 ATTAC. LISCIO § 10 1/2x100 EDR Art. ART.407/126 P/C.20

**VI)RAS**

**Tubetto In Rame Cromato**



**ROT040RA ME CROMATO**

Diam. mm	Ltrogt. dm;	'&z. per Conf.
8	500	10
10	500	10
12	500-	10
14	500	10

- 70195 TUBO RAME RIC. CR § 10 5m EDR Art. 419 P/C.1
- 70196 TUBO RAME RIC. CR § 12 5m EDR Art. 419 P/C.1
- 70197 TUBO RAME RIC. CR § 14 5m EDR Art. 419 P/C.1

**Biconi Cromati Maschi**



- 58061 395 BICONO M CR. 3/8x10 EDR Art. 1.198 P/C.10
- 58062 395 BICONO M CR. 3/8x12 EDR Art. 1.199 P/C.10
- 58060 395 BICONO M CR. 3/8x14 EDR Art. 1.200 P/C.10
- 58067 395 BICONO M CR. 1/2x10 EDR Art. 1.201 P/C.10
- 58070 395 BICONO M CR. 1/2x12 EDR Art. 1.202 P/C.10
- 58065 395 BICONO M CR. 1/2x14 EDR Art. 1.203 P/C.10

**Biconi Cromati Femmina**

**NI 3[0b1A4INA CORI DADO CROMATO**



Aura	Pz. pWConf.
3/8 x10 mnr	10
3/8 x 14 ffrf	10
1/2 x 10 mm	10
1/2 x 12 mm	10
1/2 x 14 mm	10

- 74894 385 NIPPLES FEMMINA 3/8x10 EDR Art. 1.186 P/C.10
- 74897 385 BICONO E CR 1/2x10 EDR Art. 1.189 P/C.10
- 74898 385 NIPPLES FEMMINA 1/2x12 EDR Art. 1.190 P/C.10
- 58071 385 BICONO E CR. 1/2x14 EDR Art. 1.191 P/C.10

**Biconi Cromati**

**NIPLES BICONO '00010 CROMATO**



Diam., mm	per Oonf.
	143
	1b
14	10

- 74889 398 BICONO CROMATO § 10 EDR Art. 1.523 P/C.10
- 74890 398 BICONO CROMATO § 12 EDR Art. 1.524 P/C.10
- 74891 398 BICONO CROMATO § 14 EDR Art. 1.525 P/C.10

**Biconi Cromati Curvi**

**BICONI CROMATI**



Curve 90° MM con due calotte coniche. Guarnizione conica in gomma. Rondella spaccata, ranella plana. In ottone cromato. Attacchi: 3/8". Lungh.: 70/72 cm. Confezioni da 10 pezzi.

- 70250 BICONO CURV 90° 10x10 CROM TIR Art.6510010C10 P/C.10

**Curvette Sottolavabo**



**RACCORDO ANGOLARE CON ROSONE E DADO**

Misugg Pz. per CanL  
3/8x 10,mm >i - 50  
1/2x 10mm ::  
||

- 74868 CURVETTA A 45° CR 1/2x10 EDR Art. 1.217 P/C.50

Itli

Curvetta 45° con rosone, dado normale, guarnizioni. nipples. ghiera da 318 e flangia stampate

- 74687 CURVET C/ROS 45°1/2x10 COP VBE Art. 102316 P/C.10



- 74686 COPPIA CURVETTE SOTI/2X10 FRS Art. ART. 342 P/C.1



- 74688 COPPIA CURVETTE 90° 1/2x10 e-i Art. 102402 P/C.10





**74689** COP CURVSOTC/LUNG 1/2x10 Art. 105332-171 P/C.1



### CURVETTE SOTTOLAVABO

**Tipo stampato con rosone acciaio. Attacchi: M 3/8 - M 1/2. Lungh.: 70 cm. Confezioni da 25 pezzi.**

**70198** CURVETTA SOTTOLAV 3/8x10 TIR Art. 6506010CCC P/C.10



**58085** 426 COPPIA CURVMON.3/8x10 EDR Art. 1.376 P/C.1



### SQUADRETTA CON ROSONE, NIPLES, DADO E GUARNIZIONE

Diarn.	Misura	Pz. per Conf.
10 mm	15 x 25 cm	2
12 mm	15 x 25 cm	2
15mm	15 x 25 cm	2

**Disponibile in versione OTTONATA oppure CROMATA**

**70000** SQUADR.SOTTOLAV1/2x12 OTT EDR Art. 403 OTT P/C.8

**70001** SQUADR.SOTTOLAV.1/2x12 CRO EDR Art. 403 CRO P/C.8

### Rubinetto Sottolavabo C/Filtro

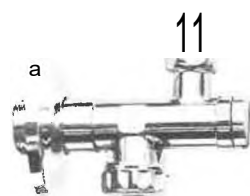

### RUBINETTO FILTRO A SFERA

Misura Pz. per Conf.  
1/2 10

**74899** RUBIN.SOTTOLAV M1/2x10 EDR Art. 405/F P/C.10



### RUBINETTO SOTTOLAVABO CON FILTRO E SNODO

Misura Pz. per Conf.  
1/2 10

**Disponibile In versione BIANCA oppure CROMATA**

**71402** RUBINETTO C/FIL SNOD CR EDR Art. 405/F-02 P/C.10

**71403** 405F-02 RUB. C/FIL SNOD BI EDR Art. 8.077 P/C.10

**71401** FILTRO INOX x RUB 405/F-02 EDR Art. C.096 P/C.1



### RUBINETTO SOTTOLAVABO 5 VIE + ATTACCO LAVATRICE

Misura Pz. per Conf.  
1/2

**74836** 475 RUBIN SOTTOL+LAVAT CRO EDR Ad. 1.806 P/C.10

### Nipples Cromati



**75234** NIPPLES CROMATO 3/8 EDR Art. 280 P/C.10

**75235** NIPPLES CROMATO 1/2 EDR Art. 280 P/C.10

**58014** NIPPLES CROMATO 3/4 EDR Art. 280 P/C.10

**58015** 280 NIPPLES CR. 1 x 1 EDR Art. 280 P/C.10

### Nipples Cromati Ridotti



**58079280** NIPPLES CROM 3/4x1/2 EDR Art. 1.096 P/C.10

**58080** 280 NIPPLES CROM 1/2x3/8 EDR Art. 1.094 P/C.10

### Gomiti Cromati Ff

### GOMITO IN OTTONE FF

Misura	Pz. per Conf.
3/8	10
1/2	10
3/4	10
1	10



**58016** 90 GOMITO OTT CR. FF 3/8 EDR Art. 1.059 P/C.10

**58017** 90 GOMITO OTT. CR. FF 1/2 EDR Art. 1.060 P/C.10

**58018** 90 GOMITO OTT. CR. FF 3/4 EDR Art. 1.061 P/C.10

**58019** 90 GOMITO OTT. CR FF 1 EDR Art. 1.062 P/C.10

Gomiti Cromati Mf



**GOMITO OTTONE MF**

perConf.

112	10
3/4	10
1	10

58025 92 GOMITO OTT. CR. MF 3/8	EDR Art. 1.065	P/C.10
58026 92 GOMITO OTT. CR. MF 1/2	<b>EDR</b> Art. 1.066	P/C.10
58027 92 GOMITO OTT. CR. Mg 3/4	<b>EDR</b> Art. 1.067	P/C.10
<b>58028 92 GOMITO OTT CR. MF 1</b>	<b>EDR</b> Art. 1.068	P/C.10

Te Cromati



**TEE MOTTO/VE**

U.Z:Per 0°nf.

3/8	10
142	10
314,,	10
1	10

58021 130 TEE 017: CROM 3/8EDR	Art. 1.071	P/C.10
58022 130 TEE 011 CROM. 1/2 <b>EDR</b>	Art. 1.072	P/C.10
58023 130 TEE 071 CROM 3/4 <b>EDR</b>	Art. 1.073	P/C.10
58024 130 TEE OTT CROM 1 <b>EDR</b>	Art. 1.074	P/C.10

Manicotti Cromati

**MANXOTTO || OTTONE**

MISTO e Fe:Toor Cani. 30

-1	10
3/4	10
1	10



71501 270 MANICOTTO CROMATO 3/8	EDR Art. 1.084	P/C.10
71502 270 MANICOTTO CROMATO 1/2	EDR Ad. 1.085	P/C.10
71503 270 MANICOTTO CROMATO 3/4	EDR Art. 1.086	P/C.10
<b>71504 270 MANICOTTO CROMATO 1</b>	<b>EDR</b> Art. 1.087	P/C.10

Tappi Cromati



71550 290 TAPPO CROMATO 3/8	<b>EDR</b> Ad. 1.104	P/C.10
71551 290 TAPPO CROMATO 1/2	<b>EDR</b> Art. 1.105	P/C.10
71552 290 TAPPO CROMATO 3/4	<b>EDR</b> Art. 1.106	P/C.10
<b>58073 290 TAPPO CROMATO 1</b> <b>EDR</b>	Ad. 1.107	P/C.10

Calotta Cromate

<b>71507 300 CALOTTA CROMATA 3/8</b>	<b>EDR</b> Art. 1.110	P/C.10
--------------------------------------	-----------------------	--------

<b>71508 300 CALOTTA CROMATA 1/2</b>	<b>EDR</b> Art. 1.111	P/C.10
<b>71509 300 CALOTTA CROMATA 3/4</b>	<b>EDR</b> Art. 1.112	P/C.10
<b>71510 300 CALOTTA CROMATA 1</b>	<b>EDR</b> Art. 1.113	P/C.10

Riduzioni Cromate



<b>71534 241 RIDUZ. CROM MF 1/2x3/8</b>	<b>EDR</b> Art. 1.078	P/C.10
<b>71535 241 RIDUZ CROM MF 3/4x1/2</b>	<b>EDR</b> Art. 1.079	P/C.10
<b>71536 241 RIDUZ. CROM MF 1x3/4</b>	<b>EDR</b> Art. 1.080	P/C.10

Ghiere Di Riduzione



<b>75232 GHIERA OTTONE 1/2x3/8</b>	EDR Art. 309	P/C.10
<b>58011 309 GHIERA OTTONE 3/4x1</b>	EDR Art. 309	P/C.10
<b>58012 309 GHIERA OTTONE 1/2x3/4</b>	EDR Art. 309	P/C.10
<b>58013 309 GHIERA OTTONE 1x1.1/4</b>	EDR Art. 1.122	P/C.10

Prolunghe Cromate 3/8



**PROLONG4 IN O.TTONE**

Kgsupt R PiT/30;7po6f.  
3/8 41'0 ff tO'  
318 -X30 mm i  
3/8 x 50mm i A0

<b>74820 PROL.CROMMF 3/810 mm</b>	<b>EDR</b> Art. ART.50	P/C.10
<b>74822 PROL.CROMMF 3/8 30 mm.</b>	<b>EDR</b> Art. ART.50	P/C.10
<b>74821 PROL.CROMMF 3/8 40 mm</b>	<b>EDR</b> Art. ART.50	P/C.10
<b>74823 PROL.CROMMF 3/8 50 mm</b>	<b>EDR</b> Art. ART.50	P/C.10

Prolunghe Cromate 1/2



<b>75237 PROLCROM.MF 1/2X10 mm</b>	<b>EDR</b> Ad. ART.50	P/C.10
<b>75238 PROLCROMMF 1/2X15 mm</b>	<b>EDR</b> Art. ART.50	P/C.10
<b>75239 PROLCROMMF 1/2X20 mm</b>	EDR Art. ART.50	P/C.10
<b>75240 PROLCROMMF 1/2X25 mm</b>	EDR Art. ART.50	P/C.10
<b>75241 PROL.CROM.MF 1/2X30 mm</b>	<b>EDR</b> Art. ART.50	P/C.10

Prolunghe Cromate 3/4



<b>75230 PROL.CROMMF 3/4X30 MM</b>	EDR Art. ART.50	P/C.10
------------------------------------	-----------------	--------

**Tappo Copriforo Cromato  
Con Rosone**



**Tappo con vite  
con rosone in ottone.  
Cromato  
Misura: M 1/2**

**75233 TAPPO C/ROSONE CROM. M1/2** VBE Art. 3601/G03282 P/C.1

**Cappuccio Universale  
Per Rubinetti Incasso**



*Cappuccio universale.  
Nel caso sia andato  
perso il cappuccio di  
qualsiasi rubinetto incasso  
questo lo sostituisce.*

**75572 CAPPUCCIO UNIV.x RUBININC** CLB Art. 284-000CR P/C.1

**75573 CAPPUCCIO UNIVERSALE OTTON** CLB Art. 284-000TT P/C.1

**Tappo Copriforo Per Ceramica**



• **Tappo copriforo 0 45 in ottone,  
per lavabo e bidet 43 mm**

**74878 TAPPO COPRIFORO PESANTE CR** EDRArt. 302

**74877 TAPPO COPRIFORO BIANCO** EDRArt. 302 BANCO P/C.1

**Eccentrici**



**58090 ECCENTRICO C/ROS CR3/8x3/4** EDR Art. 1.379-431 P/C.10

**58031 ECCENTRICO C/ROS. 1/2x3/4** EDR Art. 1.380-431 P/C.1

**58086 ECCENTRICO CROMATO 1/2x40** EDR Art. 1.384-432 P/C.1

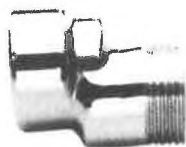

**Spostamento i cm.**

**75566 ECCENTRICO CR 1 cm 3/4x3/4** CLB Art. 221/3 P/C.1

**DISTANZIALE  
CROMATO**

**Misura Pz. per Conf.**

**1/2 x 40mm 10**  
**1/2 x 80 mm 10**



**58032 ECCENTRICO 3/4x1/2 8 cm**

**EDR Art. 1.386-432 P/C.1**



**RACCORDI ECCENTRICI  
IN OTTONE NICHELATO**

Attacchi	Spostam. inch	mm.	Pz. x conf.
MF 3/8x3/8	10	10	10
MF 3/8x3/8	20	10	10
MF 3/8x3/8	30	10	10
MF 3/8x3/8	40	10	10
MF 3/8x3/8	50	10	10
MF 3/8x3/8	60	10	10
MF 1/2x1/2	10	10	10
MF 1/2x1/2	20	10	10
MF 1/2x1/2	30	10	10
MF 1/2x1/2	40	10	10
MF 1/2x1/2	50	10	10
MF 1/2x1/2	60	10	10

**a**

**70125 RACC ECC OT/N MF3/8x3/8x20** TIR Art. 6480000S20 P/C.10

**70126 RACC ECC OTIN Ilif3/8x3/8x30** TIR Art. 6480000530 P/C.10

**70127 RACC ECC OT/N MF3/8x3/8x40** TIR Art. 6480000S40 P/C.10

**70128 RACC ECC OT/N MF1/2x1/2x20** TIR Art. 6480000520 PiO.io

**70129 RACC ECC OT/N MF1/2x1/2x30** TIR Art. 6480000530 P/C.10

**70130 RACC ECC OTIN MF1/2x1/2x40** TIR Art. 6480000840 P/C.10

**Rosette Ottone Cromate**

**ROSONE CROMATO**



Misura	Pz. per Conf.
3/8	100
1/2	100
3/4	100

**58048 412 ROSONE CROMATO 3/8** EDR Art. 1.280 P/C.100

**58049 ROSETTA CROMATA 1/2** EDR Art. 1.281-412 P/C.100

**Rosette Inox**



**ROSETTA INOX  
PER RUBINETTI**

**Tipo bombato con 0 esterno mm 60.  
In acciaio.**

**0 dIspn.: 3/8 - 1/2 - 3/4 - 1 pollici.  
Confezioni da 100 pezzi.**

**74851 ROSETTA INOX 3/8** MAV Art. 007023/8 P/C.50

**74852 ROSETTA INOX 1/2** MAV Art. 007021/2 P/C.50

**74853 ROSETTA INOX 3/4** MAV Art. 007023/4 P/C.50

**74854 ROSETTA INOX 1** MAV Art. 007021 P/C.50



**Rosette Ottone Apribili**



**ROSONE APRIBILE CROMATO**

&lima	P'z. per Cont.
3/8	50 -
1/2	50
	50
1	50
1.1/4	50

- 74855 ROSETTA APRIBILE CR 3/8      EDR Art. 413      P/C.50
- 74856 ROSETTA APRIBILE CR 1/2      EDR Art. 413      P/C.50
- 74857 ROSETTA APRIBILE CR 3/4      EDR Art. 413      P/C.50
- 74858 ROSETTA APRIBILE CR I      EDR Art. 413      P/C.50
- 74861 ROSETTA APRIBILE CR 1.1/4      EDR Art. ART.413 P/C.50



**ROSONE A SCATOLA**

Misura	Pz. per Conf.
1/2 x 10 mm	50

- 70156 ROSETTA H 10 mm DA 1/2      TIR Art. 4310.000C.1 P/C.50

**Rosoni 1/2**



**ROSONE A SCATOLA**

Misura	Pz. per Conf.
1/2 x 20 mm	25

- 58051 412/H ROSONE SCAT.§ 1/2 H20      EDR Art. 1.291      P/C.25



- 58052 412 ROSONE CROMATO 1/2 D72      EDR Art. 1286      P/C. 10

**Rosoni 3/4**



- 58050 412 ROSONE CROMATO 3/4      EDR Art. 1.282      P/C.100

**Rosoni**

**ROSONE ALTO PER CANOTTI**

Diam.	Pz. per Conf.
26 mm	50
30 m m	50
32 m m	50
40 mm	50



- 58055 415 ROSONE ALTO x CAN. §26      EDR Art. 1.300      P/C. 50
- 58056 415 ROSONE ALTO x CAN. §30      EDR Art. 1.301 P/C. 50
- 58057 415 ROSONE ALTO x CAN. §32      EDR Art. 1.302 P/C. 50
- 58058 415 ROSONE ALTOxCAN OT §32      EDR Art. 13.101 P/C. 50



**ROSONI PER CANOTTI**

**a**

Tipo conico In ottone cromato.  
Ø mm 77.  
Altezza mm 50.  
Ø fori: 40 mm.  
Confezioni da 25 pezzi.

- 74865 ROSONE A MURO § 40x77 CROM      TIR Art. 21700105 P/C. 25

**ROSONE CON PORO OVALE SENZA ALETTE**

Diarn.	Pz. per Conf.
30 mm	25 )



- 58053 409S ROSONE OV. CAS ALT 30      EDR Art. 1.271 P/C. 25



**ROSONE PER CANOTTI GIGANTE o 100**

- 58054 415/G ROSONE GIG. D100 F32      EDR Art. 1528 P/C. 10

**Guarnizioni Coniche Per Canotti Scarico**



- 74830 GUARNIZIONE CONICA §26      LEO Art. 1564      P/C. 100
- 74831 GUARNIZIONE CONICA §32      LEO Art. 1565      P/C. 100
- 74829 GUARNIZIONE CONICA §40      LEO Art. 1566      P/C. 100



### Canotti Lisci Cromati Diritti

MISURA i CONF

Sej "TT"  
mtr.

58033 417 CANOTTO O/C §26 25 cm	EDR Art. 1.315 P/C. 5
58034 417 CANOTTO O/C §30 25 cm	EDR Art. 1.319 P/C. 5
58035 417 CANOTTO O/C §32 30 cm	EDR Art. 1.324 P/C. 5
58036 417 CANOTTO O/C §26 100 cm	EDR Art. 1.317 P/C. 5
58037 417 CANOTTO O/C §30 100 cm	EDR Art. 1.321 P/C. 5
58030 417 CANOTTO O/C §32 100 CM	EDR Art. 1.325 P/C.5

### Canotti Lisci Cromati Diritti Con Cartella

#### CANOTTO CON CARTELLA CROMATO

Diam. mm Misura cm Pz. per Conf.

26	25	10
32	25	10
32	30	10

58043 417B CANOTTO CART CR.26x25	EDR Art. 1.335 PIC. 10
58044 417B CANOTTO CART CR.30x25	EDR Art. 1.398 PIC. 10
58045 417B CANOTTO CART CR.32x25	EDR Art. 1.341 P/C. 10
58046 417B CANOTTO CART CR.32x30	EDR Art. 1.342 P/C. 10

#### Canotto speciale Ø 26 con dado 1.1/4".

74838 CANOTTO §26 C/D 1.1/4 30cm	MAV Art. 5541D P/C.
----------------------------------	---------------------

### Canotti Flessibili Cromati

#### CANOTTO CROMATO PIEGHEVOLE

Diam. mm Lungh. cm Pz. per Conf.

26	30	1u
32	30	10

58039 418 CANOTTO FLESS. § 26x30	EDR Art. 1.352 P/C. 10
75512 CANOTTO FLESSIBILE §30x30	EDR Art. 418 P/C. 10
58040 418 CANOTTO FLESS. § 32x30	EDR Art. 1.358 P/C. 10

### Canotti Cromati Eccentrici

#### CANOTTO A 45 gr. PER CASSETTA WC

Diam. mm Pz. per Conf.  
30 10



58047 417/45 CANOTTO CAS ALTA 30	EDR Art. 1.349 P/C. 5
----------------------------------	-----------------------

#### CANOTTO ECCENTRICO CON ROSONE

Diam. mm Pz. per Conf.  
30 10  
32 10



58038 462 CANOTTO ECC C/ROS. §32	EDR Art. 1.507 P/C. 5
----------------------------------	-----------------------



75514 CANOTTO ECCENTRICO	CAB Art. 351530 P/C. 5
--------------------------	------------------------

#### Accessori E Minuterie Di idraulica Sifoni In Ottone Cromato A Bottiglia

as



#### SIFONE A BOTTIGLIA SENZA PILETTA - ROSONE OTTONE

Misura Lungh. cm Pz. per Conf.

1	25	50
1.1/4	25	50

70002 SIFONE BOTTS/P I 25 cm	EDR Art. 1004/9 - 1 P/C. 1
------------------------------	----------------------------

70003 SIFONE BOTTS/P 1.1/4 25cm	EDR Art. 1004/S- 1.1 PIC. 1
---------------------------------	-----------------------------



#### SIFONE A BOTTIGLIA CON PILETTA - ROSONE OTTONE

Misura Lungh. cm Pz. per Conf.

1	25	25
1 1/4	25	25

70005 SIFONE BOTT.C/P I 25 cm	EDR Art. 1004 - 1 P/C. 1
-------------------------------	--------------------------



**Sifoni In Ottone Cromato A "S"  
Per Bidet**



**SIFONE ALIESTE« SENZA  
PILETTA - ROSONE OTTONE**

Misura	Lungh. cm	Pz. per Coni.
1	251	50
1.1/4	25	50

70009 SIFONE S S/P 1 25 cm EDR Art. 1008/S - 1 P/C. 1

70008 SIFONE S SIP 1.1/4 25 cm EDR Art. 1008/5-1.1/ P/C. 1



**SIFONE A "ESSE" CON  
PILETTA - ROSONE OTTONE**

Misura	Lungh. cm	Pz. per Coni.
1	25	25
1.1/4	25	25

70010 SIFONE S C/P 1 25 cm EDR Art. 1008 - 1 P/C. 1

**Sifoni In Ottone Bianco A "S"  
Per Bidet**

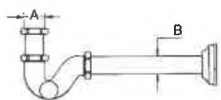

Dimensioni in mm.	
A	11/4"
B	32

N° pezzi per confezione:1

70006 SIFONE S S/P 1.1/4 BIANC GFB Art. 54011425 P/C. 1



**LUX**  
Snodino in ottone  
per comando bidet.  
Finiture nichelate.

74372 SNODINO LUX OTTONE/NICHEL VSN Art. SNOO2NIP/C.1

**ECO**

**egi** Snodino in "hostafonn"  
per comando bidet.

74373 SNODINO HOSTAFORMx BIDET VSN Art. SNOO100 P/C.1

**Sifoni In Ottone Cromato A "S"  
Per Bidet**



**SIFONE A °V; SENZA  
PILETTA - ROSONE OTTONE**

Misura	Lungh. cm	Pz. per Conf.
1	25	50
1.1/4	25	50

70012 SIFONE U S/P 1 25 cm EDR Ark 1010/S - 1 P/C. 1

70013 SIFONE U S/P 1.1/4 25 cm EDR -Art. 1010/S 1.1. P/C. 1



**SIFONE A "U" CON  
PILETTA - ROSONE OTTONE**

Misura	Lungh. cm	Pz. per Conf.
1	25	25

70014 SIFONE U C/P 1 25 cm EDR Art. 1010- 1 P/C. 1

**Prolunga Telescopica Per  
Canotti Cromata**



**PROLUNGA PER  
CANOTTO**

Diam. mm	Lungh. cm	Pz. per Conf.
26	14	10
30		10
32		10

70022 PROLUNGA TELES OR/G §26x14 EDR Art. 424 §26 P/C. 10

70021 PROLUNGA TELES OR/G § 30 EDR Art. 424 § 30 P/C. 10

70023 PROLUNGA TELES OR/G §32x14 EDR Art. 424 §32 P/C. 10

**Pilette In Ottone Cromato Con Troppo Pieno**

**011' PILETTA PER LAVABO O BIDET  
CON GRIGLIA - COMPLETA DI  
DADO E CODULO mm 60**

Misura	Lungh. cm	Pz. per Conf.
1	9	50
1.1/4	9	50

70043 PILETTA LAV/BID C/TP 1 CM9 EDR Art. 1013/S prc. 4

70044 PILETTA LAVABO C/TP 1.1/4 EDR Art. 1013/S P/C. 3



**PILETTA PER LAVABO O BIDET  
CON GRIGLIA  
SENZA TROPPO PIENO**

Misura	Lungh. cm	Pz. per Conf.
1	9	100
1.1/4	9	50

**70049** PILETTA LAV/BID S/TP 1.9CA/I EDR Art. 1013/S P/C. 100



**PILETTONE LAVELLO CON  
E. SENZA TROPPO PIENO**

Misura	Pz. per Conf.
1.1/4	50

**70058** PILETTONE C/TP 1.1/4 EDR Art. 1015/5 P/C. 50

**70059** PILETTONE S/TP 1.1/4 EDR Art. 1015/6 P/C. 2



**PILETTA CON  
SALTARELLO**

Misura	Pz. per Conf.
1.1/4	1

**75568** PILETTA C/SALTARELLO 1 EDR Art. 1080 P/C. 1

**75570** PILETTA C/SALTARELLO 1.1/4 EDR Art. 1080 P/C. 1



**PILETTA "GATTINARA" CON  
GRIGLIA IN ACCIAIO INOX  
18/8, DADO E CODULO mm 60**

Misura	Lungh. cm	Pz. per Conf.
1 1/4	80	100

**70068** PILETTA GATTINARA 1.1/4 EDR Art. 1014/S P/C. 2



**PILETTONE SIFOIDE PER PIATTO  
DOCCIA CON DADO E  
CODULO CURVO mm 60**

Misura	Pz. per Conf.
1	50
1.1/4	50

**70072** PILETTA DOCCIA COD/CU 1 EDR Art. 1020 P/C. 2

**70073** PILETTA DOCCIA CO/CU 1.1/4 EDR Art. 1020 P/C. 2



**PILETTONE SIFONATO PER  
PIATTO DOCCIA PESANTE**

Misura	Pz. per Conf.
1.1/4	3

**70096** PILETTA SII.. x DOC. 1.1/4 EDR Art. 1030 P/C. 1

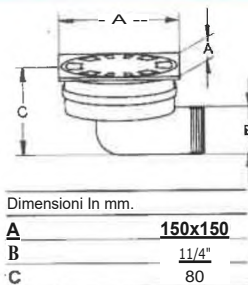
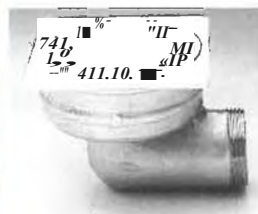

Dimensioni in mm.

A	150x150
B	1 1/4"
C	80

N° pezzi per confezione: 1

**70080** PILETTONE PAVIM QUA.15x15 GFB Art. 854P150 P/C. 2

**Accessori Per Pilette**

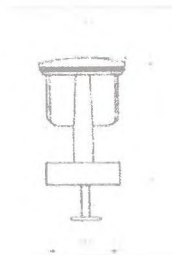

**75562** TAPPO SALTARELLO 1 CLB Art. 346-00100 P/C. 1

**75564** TAPPO SALTARELLO 1.1/4 CLB Art. 346.00114 P/C. 1



**70155** TAPPO x PILET SALTARELLO 1 TIR Art. 4119.000c P/C. 10



Permette di coprire fino al bordo la piletta ed è quindi adattabile a molte situazioni.

sy

**75510** TAPPO COPER. PILETTA 1.1/4 CLB Art. 349-00114 P/C. 1



**RIDUZIONE IN OTTONE**

Misura	Pz. per Conf.
3/8 x 1/2	10
1/2 x 3/4	10
3/4 x 1	10
1 x 1.1/4	10

**58059** 60 RIDUZ. OT7' CR. 1x1.1/4 EDR Art. 1.054 P/C. 10

**Accessori Per Pilettoni**



**GRIGLIETTE (Cff)  
PER LAVANDINI "iv"  
In acciaio 430.  
Confezioni da 50 pezzi.**

**74841** GRIGLIETTA INOX MAV Art. 01107 P/C. 1



CAMPANELLA PER  
VASCA INOX  
Alt. 55 mm - Ø 44 mm  
(Confezioni da 10 pezzi)

74842 CAMPANELLA INOX LAVELLO EDR Art. C.727 P/C. 1



CAMPANELLA PER  
VASCA INOX  
Alt. 36 mm - Ø 40 mm  
(Confezioni da 10 pezzi)

74843 CAMPANELLA INOX VASCA EDR Art. C.728.1017 P/C. 1

**Cado!! E Dadi Per Pilette**

**DADO CON CODULO  
DIRITTO mm 60**



Misura Lung. mm Pz. per Conf.

	75	10
1.1/4	75	10
1.1/2	75	10

70083 DADO E CODULO DRITTO DA I EDR Art. 1050 P/C. 1

70081 DADO E CODULO DRITTO 1.1/4 EDR Art. 1050 P/C. 1

70085 DADO E CODULO DRITTO 1.1/2 EDR Art. 1050 P/C. 1

**DADO CON CODULO  
CURVO**



Misura	Pz. per Cont.
1	10
1 1/4	10
1.1/2	10

70082 DADO E CODULO CURVO 1.1/4 EDR Art. 1055 P/C. 1

**Colonna Vasca Semplice Con  
Tappo E Catenelle 1,1/4**

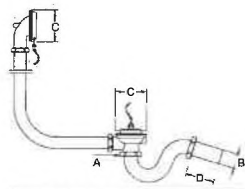

Dinendoni

A	32
B	70
C	75

N° pezzi per confezione: 1

70062 PILETTA VASCA S C/T 1.1/4 GFB Art. 750114N P/C. 1

**Sifone Vasca In Rame Da 1,1/2**

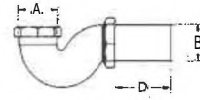

Dimensioni In mm.

A	40
B	75
D	75

N° pezzi per confezione: 1

70064 SIFONE VASCA S 1.1/2 GFB Art. 770112 P/C. 1

**Sifone Vasca**

**SIFONE VASCA  
CON SNODO**

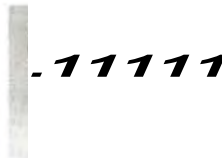

O mm	Pz. x conf.
40-50 x 1.1/4	10
40-50 x 1.1/2	10

70405 SIFONE VASCA C/SNODO HL500 WAV Art. 609734 P/C. 1

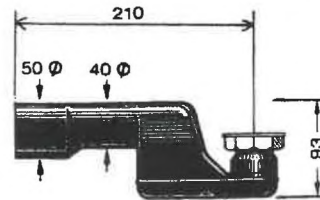

70406 SIFONE x VASCA D/OTT 1.1/2 Ovi Art. 900105 P/C. 1

**Telo Di 120x110  
Per Creare Piatto Doccia  
Con Piletta Sifonata**



**SIFONE PER DOCCIA**

O mm	Pz. x conf.
40/50	5

Completo di Telo 120 x 110 cm

70417 PIATTO DOCCIA+SIF 120X110 WAV Art. PD 304022 P/C. 1

**Accessori Per Scarichi**

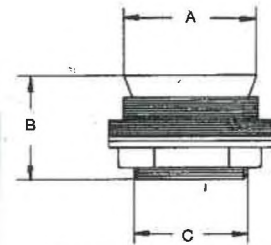

Dimensioni in mm.

A	48
B	87
C	11x.

N° pezzi per confezione: 1

70089 MORSETTO TURCA GFB Ad. 81087 PIC. 1



§ 20 mm

**74832** CANOTTO x LAVATRICE CR 26 MAV Art. 01457AD26 P/C. 5

**74833** CANOTTO x LAVATRICE CR 32 MAV Art. 01457AD32 P/C. 5



**74828** CURVA LAVATRICE ABS CROM MAV Art. 01456/A P/C. 10



### RACCORDI PORTAGOMMA

**Raccordi portagomma curvi in ABS cromata per lavatrice. Completati di guarnizione e dado in ottone cromato. Attacco: 1". Confezioni da 10 pezzi.**

**74834** CURVA SCARICO LAVATR. 017" TIR Art. 783100AC P/C. 1

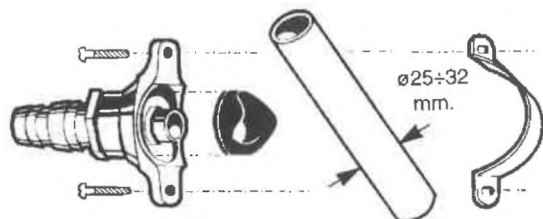

**75923** PRESA SCAR x TUBI 25-32 mm IPR Art. 700/0 P/C. 1

### Tubi Carico Lavatrice



### Tube carico lavatrice-lavastoviglie

Anelli di serraggio in metallo.  
Confezioni singole (busta di plastica).  
5 attacchi 3/4"

**75381** TUBO CARICO FF 1.00 m COT Art. 080 080 100 P/C. 1

**75382** TUBO CARICO FF 1.50 m COT Art. 080 080 150 P/C. 1

**75383** TUBO CARICO FF 2.00 m coi Art. 080 080 200 P/C. 1

**75384** TUBO CARICO FF 2.50 m coi Art. 080 080 250 P/C. 1

**75385** TUBO CARICO FF 3.00 m coi Art. 080 080 300 P/C. 1

### Tubi Scarico Lavatrice



### Tube scarico lavatrice-lavastoviglie

Confezioni singole (busta di plastica).

**75386** TUBO SCARICO 1.5 m COT Art. 090 020 150 P/C. 1

**75387** TUBO SCARICO 2.0 m COT Art. 090 020 200 P/C. 1

**75388** TUBO SCARICO 2.5 m cor Art. 090 020 250 P/C. 1

**75389** TUBO SCARICO 3.0 m cor Art. 090 020 300 P/C. 1

### Accessori Per Scarichi Lavatrice



Dictrn. attacchi mm 21.

**75580** PORTAGDOPPIO SCAR.LAV § 15 IPR Art. 510/0S P/C. 10

**75579** PORTAGDOPPIO SCAR.LAV § 17 IPR Art. 510/2S P/C. 10

**75578** PORTAGDOPPIO SCAR.LAV 02 IPR Art. 510/4S M. 1



**70090** PORTAGLAVAT.SQ. DADO PLAS GFB Art. 2364 P/C. 1



Attacchi da 3/4"

**75574** RACCORDO DOPPIO CAR LAVATR IPR Art. 541/05 P/C. 1

14# triff#

**75576** NIPPLES PLAST x LAVAT 3/4 IPR Art. 500/05 P/C. 1



**74881** CURVA LAVATR MF 3/4x3/4 IPR Art. 060/25 P/C. 1

*Sifoni In Plastica Geberit  
Lavatrice Lavastoviglie*

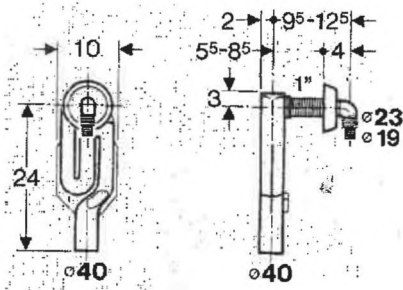

**Con rosone e portagomma cromati.  
Con cappa di protezione per  
montaggio grezzo.  
Scarico diametro 40 mm.**

**70561 SIFONE INCASSO x LAVATRICE** GEB Art. 1527721 P/C. 1

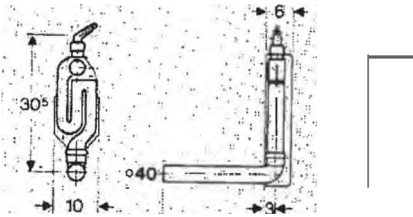

**Curva scarico lavatrice  
Diametro 23-19**

**70599 SIFONE ESTERNO x LAVATRICE** GEB Art 152788 P/C. 1

**Doccia**

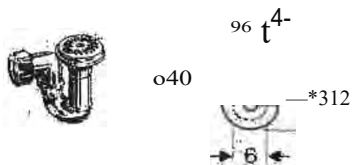

**70506 SIFONE x DOCCIA GRES 2** GEB Art. 150071.21 P/C. 1

**70507 SIFONE x DOCCIA ACC. 1.1/2** GEB Art. 150125.00 P/C. 1



**79194 GRIGLIA x PILETTA DOCCIA** GEB Art. 240556.00 P/C. 1

**Vasca**

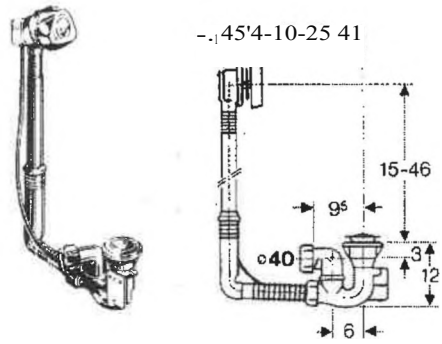

**70503 COLONNA VASCA SALT/AUT** GEB Art 150603.21 P/C. 1



*Per cambiare le finiture di colore  
alle colonne vasca Geberit da  
cromo a bianco oppure dorato.*

**79191 ACCESSORI SIFON VASCA BIA** GEB Art. 150220.XX P/C.1

**79192 ACCESSORI SIFON VASCA DOR** GEB Art. 150220.DS P/C.1

**79193 ACCESSORI SIFON VASCA CROM** GEB Art. 150220.21 P/C.1

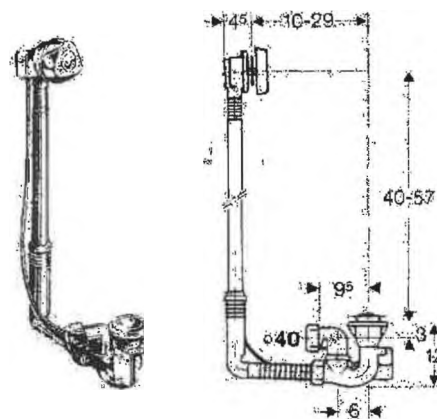

*Per vasche a sedere.  
con piletta e saherello.  
Rosone cromato per troppo pieno.  
Scarico girevole con raccordo  
a guarnizioni.  
Attacco scarico diametro 40 mm.  
Già sifonata.*

**70504 COLONNA VASCA SEDILE SALT** GEB Art. 150605.21 P/C. 1

■ **GEBERIT**

■ **GEBERIT**



Per il collegamento a colonne vasca senza sifone

Con dado 1,1/2" ed anello riduttore.  
 Attacchi 1,1/2"x1,1/4".  
 Scarico diametro 40 mm.  
 Scarico girevole con raccordo,  
 con guarnizioni.

70509 SIFONE x VASCA C/RACCORDO GEB Art. 150081 P/C. 1

**Lavabi E Bidet**

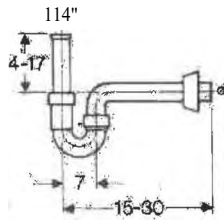

70537 SIFONE x LAVABO 1.1/4 x 40 GEB Art. 151100.11 P/C. 1

70408 SIFONE LAVAB HL 137 1.1/4 DTA Art. 201041 P/C.

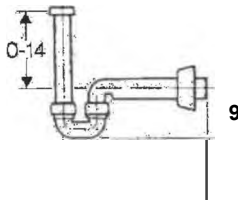

70539 SIFONE x BIDET 1.1/4 x 40 GEB Art. 151108.11 P/C. 1

**Lave!!!**

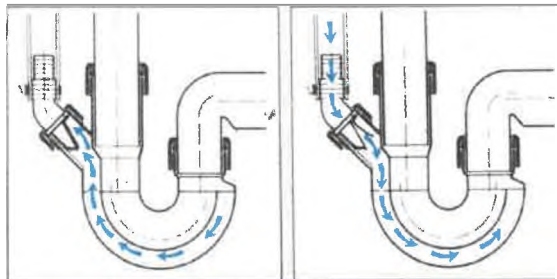

Questi tipi di sifoni hanno di serie una doppia camera con raccordo per lavatrice o lavastoviglie.  
 Il dispositivo antirisucchio evita un riaffluire della schiuma o dell'acqua nella lavatrice e lavastoviglie.

70570 SIFONE IV CAMANTIRIS § 40 GEB Art. 152889 P/C. 1

70571 SIFONE 2V CAMANTIRIS § 40 GEB Art. 152890 P/C. 1

**Sifoni Plastica Emu Scarichi Lavatrice Lavastoviglie**

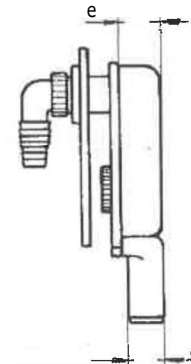

Dimensione in Mm

A 40

B 40

N° pezzi per confezione: i

70091 SIFONE LAVATRICE INCASSO EMU Art. 723 P/C. 1

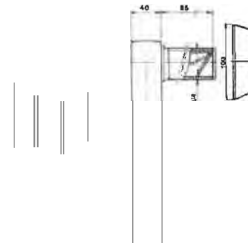

POLIOLEFINA BIANCA  
 ABS CROMATO

71031 SIFONE INC LAVATAIVTIRIFLU EMU Art. 670 P/C.1

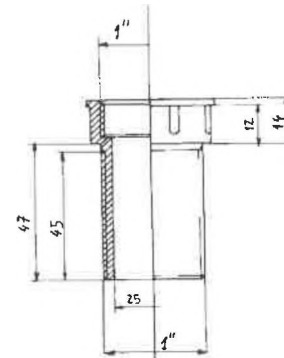

**Prolunga filettata per sifoni' da 1" per lavatrice da incasso**

**Realizzato in polipropilene bianco**

70092 PROLUNGA FILET X SIFONI I EMU Art. 719 P/C.







**Pozzetto**

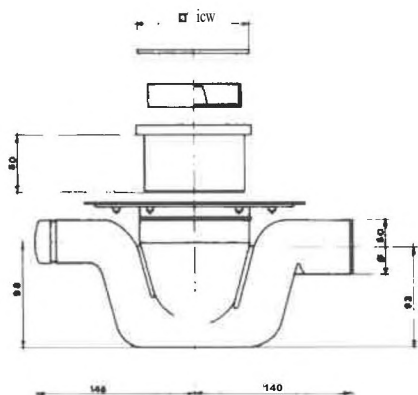

**- MAXI PILETTA A PAVIMENTO**

- PF. I/D NERO SALDABILE
- REGOI A13111

**71005 PILETTA PAVIM2VIE 100x100** EMU Art. 713 P/C. 1

**Turca Scendente**



POLIPROPILENE GRIGIO  
ATTACCO SUPERIORE CON ROTAZIONE 90° 4- 60°  
REGOLAZIONE INFERIORE A CANOCCHIALE

**71015 TUBO CACCIATA INCASSO REG** EMU Ad. 645 P/C.25

**Allaccio Wc**

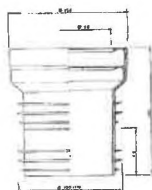

EVA BIANCO

**71019 GUARNIZIONE WC CENTRICA** EMU Art. 647 P/C.50

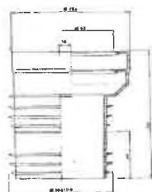

EVA BIANCO  
ECCENTRICITA 18 mm

**71020 GUARNIZIONE WC ECCENTRICA** EMU Art. 648 P/C.50

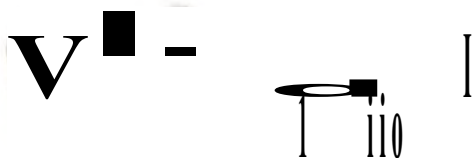

**74893 PROLUNGA NORMALE CENTRICA** CLB Art 56-0000D P/C.1

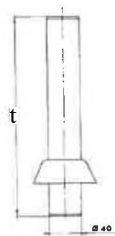

POLIPROPILENE BIANCO

**71027 CANOTTO ALLACC AL VASO** EMU Art. 174 P/C.1



**HTSK - RACCORDO BIANCO WC  
ECCENTRICO CON GUARNIZIONE**

O D	L	■
110	160	20

**44131 ATTACCO WC RIGIDO ECC. 100 OLV** Art. 900905



**75526 MANICOTTO PVC ECCENTR WC** CLB Art. 155-0000E



**Spostamento: 4 cm**

**75527 MANICOTTO ECC. WC 40x90/110** CLB Ad. 155-2268



**44122 ATTACCO WC RIGIDO DIR. 110** WAV Art. 243032.817

**Scarichi Lavabi E Lavelli  
Estensibile**

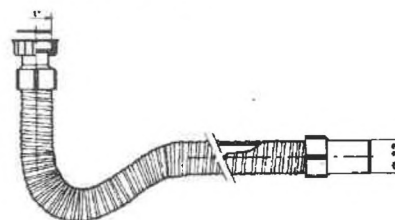

- 71032 ADAT7: EMUFLEX 32x1 40** EMU Art. 101 P/C.1
- 71033 ADATT. EMUFLEX 32x1.1/4 40** EMU Art. 103 P/C.1
- 71034 ADATT. EMUFLEX 40x1.1/2 40** EMU Art. 105 P/C.1
- 71035 ADATT. EMUFLEX 32x1 75** EMU Art. 102 P/C.1
- 71036 ADAT7: EMUFLEX 32x1.1/4 75** EMU Art. 104 P/C.1
- 71037 ADA77: EMUFLEX 40x1.1/2 75** EMU Art. 106 P/C.1





**Flessibili Estensibili  
Per Scarichi Lavabi E Lavelli**



**Canotto estensibile  
In PVC 2  
dado in ottone  
o 26  
o 32  
o 40**

- 75551 CANOTTO EST PVC D/OTT § 26 CLB Art. 361-026E5 P/C. 1  
75552 CANOTTO EST PVC D/OTT § 32 CLB Art. 361-032ES P/C. 1  
75553 CANOTTO EST PVC D/OTT § 40 cui Art. 361-040ES P/C.

**Flessibili Per Scarichi  
Lavabi E Lavelli**



**Colore grigio chiaro o mm. 25x31  
Filetto 1"  
o esterno manicotto mm.32  
Colore grigio chiaro o mm. 25x31  
Filetti 1"1/4  
o esterno manicotto mm.32  
Colore grigio scuro metallizzato  
o mm. 32x38 Filetto 1"1/2  
o esterno manicotto mm. 40**

- 70131 FLESSIB. EASY SCARICO 1x75 TIR Art. 427000PB75 P/C. 1  
70132 FLESSIB. EASY SC. 1.1/4x75 TIR Art. 427000PB75 P/C. 1  
70134 FLESSIB. EASY SC. 1.1/2x75 TIR Art. 427000PG75 P/C. 1

**in Rotoli Da 15 Mt**

**TUBI PER FLESSIBILI  
"EASYFLEX"**



**O disponibili: 25x31 e 32x38 mm.  
In materiale plastico.  
Colore: grigio chiaro  
grigio scuro  
bianco ceramica.  
Rotoli da 75 metri.  
Confezioni da 15 rotoli.**

- 70136 TUBO x SC. EASY 32 1-1.1/4 TIR Art. 427001PB32 MT/CONF. 15  
70137 TUBO x SC. EASY 40 1.1/2 TIR Art. 427001PG40 MT/CONF. 15

**Dado**



**RACCORDI "EASYFLEX"  
CON DADO GIREVOLE**

Dado F inch	Per tubo mm	Colore	Pz. x tubo conf.
1	25x31	grig. chi.	24
1.1/4	25x31	grig. chi.	24
1.1/2	32x38	gr. scu.	24
1.1/2	32x38	bia. cer.	24

- 70139 RACCORDO C/DADO EASY 1 TIR Art. 427002PB1 P/C. 1  
70140 RACCORDO C/DADO EASY 1.1/4 TIR Art. 427002PB114 P/C. 1  
70141 RACCORDO C/DADO EASY 1.1/2 TIR Art. 427002PG112P/C. 1



- 70158 MANICOTTO OTT.CR.CANOT. 30 MAV Art. 00568030 P/C. 10

**Terminale**

**MANICOTTI  
"EASYFLEX"**



est. mm	Per tubo O mm	Colore tubo	Pz. x conf.
25/26	25x31	grig.chi.	24
32	25x31	grig. chi.	24
40	32x38	gr. scu.	24
40	32x38	bia. cer.	24
32	32x38	bia. cer.	24
34,2/36,5	32x38	bia. cer.	24

- 70142 MANICOTTO EASY 321-1.1/4 TIR Art. 427003PB32 P/C. 1  
70143 MANICOTTO EASY 40 1.1/2 TIR Art. 427003PG40 P/C. 1

**Anello Per Fare Il Sifone**



**ANELLI PER  
RACC. EASYFLEX**

**Cromati.  
Disponibili in due misure:  
- per tubi da 1 - 1.1/4 inch.  
- per tubi da 1.1/2 inch.  
Confezioni da 700 pezzi.**

- 70145 ANELLO x EASY 1-1.1/4 TIR Art. 4270.04FZ P/C. 1  
70146 ANELLO x EASY 1.1/2 TIR Art. 4270.04FZ P/C. 1

**Manicotto Ff Con Or**



**MANICOTTI IN OTTONE  
PER CANOTTI**

**Giunzioni per canotti,  
tenute interna con anelli O' RING,  
in ottone cromato.  
Per canotti 0: 24/26/30/32/40 mm.  
Confezioni da 10 pezzi.**

- 70149 MANICOTTO OTT.CR.CANOT. 26 MAV Art. 00568D26 P/C. 10  
70150 MANICOTTO OTT.CR.CANOT. 32 MAV Art. 00568D32 P/C. 10  
70151 MANICOTTO OTT.CR.CANOT. 40 MAV Art. 00568040 P/C. 10

**Manicotto Ff Ridotto Con Or**



**MANICOTTI IN OTTONE  
RIDOTTI**

**Doppi bicchieri ridotti In ottone cromato,  
tenuta interna con anelli O' RING.  
Per canotti 0: 32 x 26 / 40 x 32 mm.  
Confezioni da 10 pezzi.**

- 70152 MANIC.RID.CR.32 OR- 26 OR MAV Art. 00569 26X32 P/C. 10  
70153 MANIC.RID.CR.40 OR- 32 OR MAV Art. 00569 40X32 P/C. 10



- 70154 BICCHRID.OTT.32OR-26 SALD MAV Art. 00567 32X26 P/C. 10

**Terminale F Con Or E Codolo Da Saldare A Stagno**



**BICCHIERI IN OTTONE PER PIOMBO**

*Bicchieri ridotti in ottone cromato, tipo pesante per saldatura, per canotti 0 mm. 32/40 e tubi piombo 0 mm. 26/32 Confezioni da 10 pezzi.*

**70147 BICCH.OTT. 40 OR-32 SALD** MAV Art. 00567/C P/C 10

**70148 BICCH.OTT. 40 OR-40 SALD** MAV Art 05661140 P/C. 10

**Lavabi E Biclet**

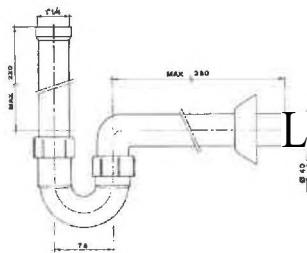

POLIPROPILENE BIANCO

**71040 SIFONE LAVABO S 1.1/4 EMU** Art. 114 P/C.1

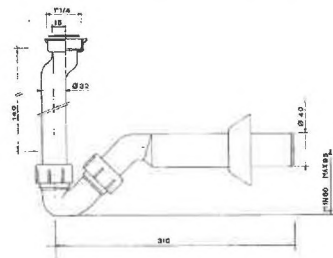

POLIPROPILENE BIANCO

**71041 SIFONE BIDET S 1.114** Ennu Art. 115 P/C.1

**Lavelli**

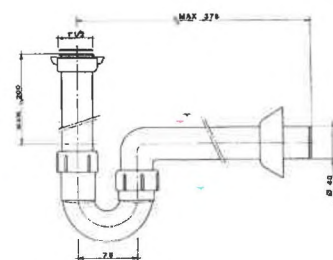

POLIPROPILENE BIANCO

**71048 SIFONE LAVELLO 1VIA S/PIL** EMU Art. 125 P/C.1

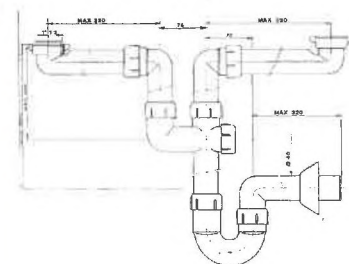

POLIPROPILENE BIANCO

**71050 SIFONE LAVELLO 2VIE S/PIL** EMU Art. 154 P/C.1

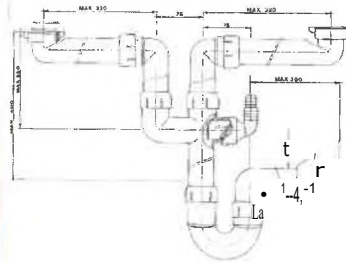

POLIPROPILENE BIANCO

**71051 SIP LAVELLO 2VIE S/PIL A/LAV** EMU Art. 155 P/C.1

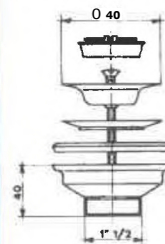

POLIPROPILENE BIANCO

**71054 PILETTA x SIFONE LAVELLO** EMU Art 162 P/C.1

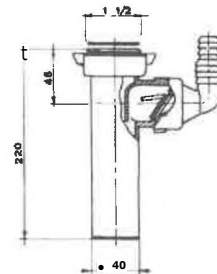

**CANOTTO DN 40x1"1/2 CON ATTACCO LAVATRICE COMPLETO DI DISPOSITIVO ANTIRISUCCHO (Mod. Dep.)**

**71055 CANOTTO ATFLA VAT 40x1.1/2** EMU Art. 163 P/C.1

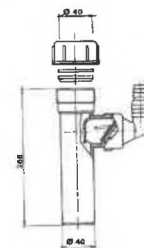

**CANOTTO DN 40 x DN 40 CON ATTACCO LAVATRICE COMPLETO DI ANTIRISUCCHIO**

**71056 CANOTTO ATT/LAVAT 40x40** EMU Art. 164 P/C.1

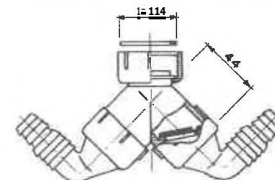

**ATTACCO DOPPIO PER LAVATRICE E LAVASTOVIGLIE CON DISPOSITIVI ANTIRISUCCHIO**

**71057 ATTACCO DOPPIO x LAVATR** EMU Art. 165 P/C.1

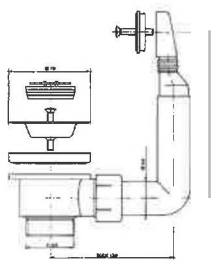

**PILETTA CON TROPPO PIENO PER LAVELLO INOX COMPLETA DI TAPPO**

**71058** PILETTA C.T.P. x LAVEL/INX EMU Art. 166 P/C.1

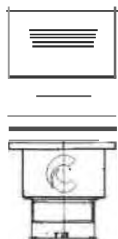

**Lenefit FICO PB LA**

**71059** PILETTA S.T.P. x LAVEL/INX EMU Art. 167 P/C.1

**Accessori Emu**

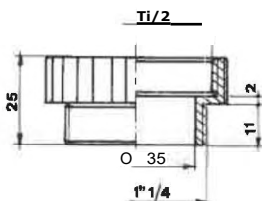

POLIPROPILENE BIANCO

**71068** RIDUZIONE 1.1/2Fx1.1/4M OLV Art. 900543 P/C.20

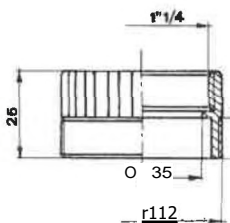

POLIPROPILENE BIANCO

**71071** RIDUZIONE 1.1/2Mx1.1/4F EMU Art. 677 P/C.20

**Sifoni In Plastica Bonomini E Ghidini X Lavello Canotto Ottone**

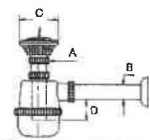
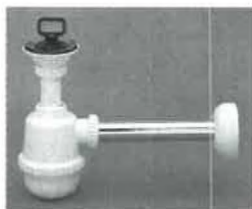

Dimensione in mm	
A	1 lit
B	32
C	80
D	5D

N° pezzi per confezione: 1

1,1/4"

**70204** SIFONE C/OT IV C/PIL 1.1/4 BON Art. 1376CT54.0 P/C. 1

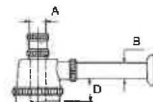

1,1/4"

Dimensione in mm	
A	1 lit
B	32
D	50

N° pezzi per confezione: 1

**70206** SIFONE C/OT 1 V S/PIL 1.1/4 BON Art. 1370CT54.0 P/C. 1

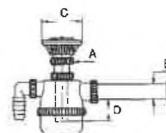

1,1/4"

Dimensione in mm	
A	1 1/4*
B	32
C	80
D	50

N° pezzi per confezione: 1

**70212** SIFONE C/OT IV CIPIL LAVAT GFB Art. 3101140 P/C. 1

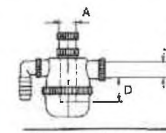

1,1/4"

Dimensione in mm	
A	1 1/4*
B	32
D	50

N° pezzi per confezione: 1

**70210** SIFONE C/OT IV S/PIL LAVAT GFB Art. 3111140 P/C. 1

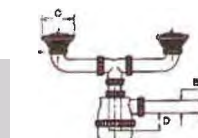

1/4"

Dimensione in mm	
A	1 lit
B	32
D	50

N° pezzi per confezione: 1

**70208** SIFONE C/OT 2V C/PIL 1.1/4 BON Art. 1386CT54.0 P/C. 1

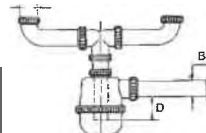

1,1/4"

Dimensione in mm	
A	1 1/4*
B	32
D	50

N° pezzi per confezione: 1

**70202** SIFONE C/OT 2V S/PIL 1.1/4 BON Art. 1380cT54.0 P/C. 1

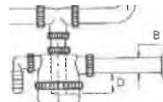
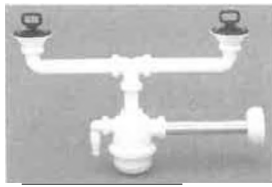

Dimensione In mm / 1/4"

A	1
B	32
C	80
D	50

N° pezzi per confezione: 1

70216 SIFONE C/OT 2V C/PIL LAVAT GFB Art. 3121140 P/C. 1

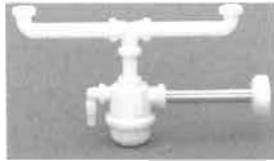

Dimensione In mm 11'4"

A	1 ne
B	32
C	50

N° pezzi per confezione:

70214 SIFONE CVOT 2VS/PIL LAVAT GFB Art. 3131140 P/C. 1

Sifoni In Plastica Lira X Lavello Canotto Ottone



### SIFONI PER LAV. CERAMICA UNA VASCA

Sifoni tipo "M" completi di pilette (acc. inox 18/8 - Ø 80 x 52), tappomaniglia Ø 52 mm, guarnizioni e tubo di scarico.

MODELLI DISPONIBILI:

- Sifone base con scarico in ottone Ø 35 mm. Bianco. Conf. da 100 pezzi.
- Sifone con attacco lavastoviglie orizzontale (Ø 20-25 mm) con scarico in ottone Ø 40 mm. Bianco. Conf. da 65 pezzi.

70301 SIFONE I V x CERAMICA § 35 LIR Art. 1311.001 P/C 1

70302 SIFONE I V x CERAM + LAV40 LIR Art. 1311.023 P/C. 1



### SIFONI PER LAV. INOX UNA VASCA

Sifoni tipo "M" senza pilette, completi di raccordi, guarnizioni e tubo di scarico.

MODELLI DISPONIBILI:

- Sifone base con scarico in ottone Ø 35 mm. Racc.: 1,7/2. Bianco. Conf. da 100 pezzi.
- Sifone con attacco lavastoviglie orizzontale (Ø 20-25 mm) con scarico in ottone Ø 40 mm. Racc.: 1.1/2. Bianco. Conf. da 70 pezzi.

70306 SIFONE I V x INOX § 35 LIR Art. 1333.002 P/C. 1

70307 SIFONE I V x INOX + LAV 40 LIR Art. 1333.108 P/C. 1

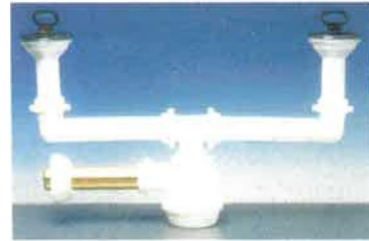

### SIFONI PER LAV. CERAMICA DUE VASCHE

Sifoni tipo "M" completi di pilette (occ. INOX 18/8 - Ø 80 x 53 mm), tappomaniglia Ø 52 mm, guarnizioni e tubo di scarico.

MODELLI DISPONIBILI:

- Sifone base con scarico in ottone Ø 35 mm. Bianco. Conf. da 50 pezzi.
- Sifone con attacco lavastoviglie verticale (Ø 20-25 mm) con scarico in ottone Ø 40 mm. Bianco. Conf. da 45 pezzi.

70311 SIFONE 2Vx CERAMICA § 35 LIR Art. 1411.007 P/C. 1

70312 SIFONE 2Vx CERAM + LAV40 LIR Art. 1411.045 P/C. 1



### SIFONI PER LAV. ACCIAIO DUE VASCHE

Sifoni tipo "M" senza pilette, completi di raccordi, guarnizioni e tubo di scarico.

MODELLI DISPONIBILI:

- Sifone base con scarico in ottone Ø 35 mm. Racc.: 1,7/2. Bianco. Conf. da 50 pezzi.
- Sifone con attacco lavastoviglie verticale (Ø 20-25 mm) con scarico in ottone Ø 40 mm. Racc.: 7,7/2. Bianco. Conf. da 50 pezzi.

70316 SIFONE 2Vx INOX § 35 LIR Art. 1433.026 P/C. 1

70317 SIFONE 2Vx INOX + LAV.40 LIR Art. 1433.057 P/C. 1

**PILETTA UNIVERSALE  
SENZA TROPPO PIENO**  
Completa di guarnizioni e tappo.  
Uscita da 7,7/2.  
Conf. da 300 pezzi.

**Iipi**

**70331 PILETTA UNIV S/TP x INOX**

LIR Art. 1911.005 P/C. 1



**PILETTA UNIVERSALE  
CON TROPPO PIENO**  
Completa di guarnizioni e tappo.  
Uscito da 7,7/2.  
Conf. da 180 pezzi.

**70332 PILETTA UNIV C/TP x INOX**

LIR Art. 1711.008 P/C.1

**ir**

**PROLUNGA "JOLLY"**  
Disponibile in due misure:  
**Ø 40 x 250 mm. (1.1/2)**  
**Ø 32 x 180 mm. (1.1/4)**  
Bianca. Conf. da 10 pezzi.

**70333 PROLUNGA JOLLY 40 x 250**

LIR Art. 8244.207 P/C. 10



**GUARNIZIONE  
PER SIFONI**  
Ø 40 mm.  
Conf. da 100 pezzi.

**70334 GUARNIZIONE OR 4375**

LIR Art. 8028.204 P/C. 1

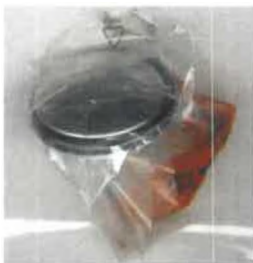

**TAPPO COPRIFORO**  
In acciaio INOX 18/8.  
Metallizzata  
Conf. da 100 pezzi.

**70335 TAPPO COPRIF AC/INOX 18/8**

LIR Art. 9.0809.01 P/C.1



**ALLACCIAMENTO PER LAVATRICE**  
Completo di guarnizioni, dadi e  
portagomma universale.  
**Per sifoni Ø 40 mm.**  
Bianco. Conf. da 150 pezzi.

**70336 ACCESS. SIF. x ALLAC. LAV.** LIR Art. 8241.001/99 P/C. 1



**RACCORDI CURVI PER SIFONI.**

**Versioni disponibili:**

- **Racc. a stringete** Lungh.: 20 cm.  
Ø 40 mm. Conf. in blister.
- **Racc. filettato F 1.1/2** Lungh.: 25 cm.  
Ø 40 mm. Conf in blister.

**70337 RACC. CURVO A STRING § 40** LIR Art. 002424 P/C.1

**70338 RACC.CURVO FILETTATO L 1/2** LIR Art. 002431 P/C.1



**TAPPOMANIGLIA**

Ø 2 pollici.  
DINO 50.5- 10° a norme.  
Nero.  
Conf. da 100 pezzi.

**70339 TAPPOMANIGLIA § 50.5**

LIR Art. 8.0646.01 P/C.10



**SIFONE SPAZIO UNO**

Permette la completa utilizzazione dello  
spazio sotto il lavello INOX ad una vasca.  
Con tubo di scarico in ottone Ø 40 mm.  
Racc.: 1.1/2. Bianco. Conf. da 60 pezzi.

**70345 SIF IV SPAZIO I S/OTT § 40** LIR Art. 9.1279.06 P/C. 1



### SIFONE SPAZIO DUE

Permette la completa utilizzazione dello spazio sotto il lavello 1NOX a due vasche. Con tubo di scarico in ottone Ø 40 mm. Racc.: 1.1/2. Bianco. Conf. da 34 pezzi.

70350 SIF 2V SPAZIO 2 S/OTT § 40 LIR Art. 9.1275.02 P/C. 1

### CANOTTI IN OTTONE

Ø 35 mm. Lungh.: 20 cm.  
Ø 36 mm. Lungh.: 20 cm. DN 40

70340 CANOTTO OTTONE x SIF § 35 LIR Art. 002236 P/C.1

70358 CANOT OTT x SIF DN 40 21cm LIR Art. 8244103 P/C.1



### RIDUZIONE IN MOPLEN

Disponibile in tre misure:

Ø 40 x 30

40 x 32

Ø 50 x 40

Conf. da 100 pezzi.

70359 RIDUZIONE MOPLEN 40x32 LIR Art. 8.4032.02 P/C.1

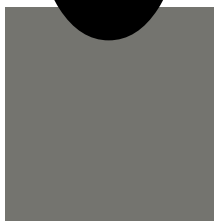

### PILETTA UNIVERSALE PER CERAMICA (Gattinara)

Completa di guarnizioni e tappo. Usotta da 1.1/2. Corit da 100 pezzi.

70370 PILETTA UNIVERS x CERAM LIR Art. 2011.000 P/C. 1

### Pilette Basket rzi 90 Per Lavelli Da Cucina

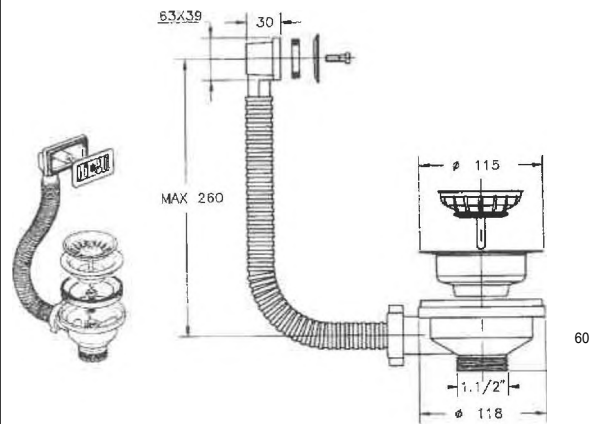

70421 PILETTA CTP ROT § 90 INOX BON Art. 1924LX6480 P/C.1

70423 PILETTA CTP ROT §90 RESINA BON Art. 1925LX6480 P/C.1

70424 PILETTA CTP RETT §90 RESIN BON Art. 1923LX64B0 P/C.1

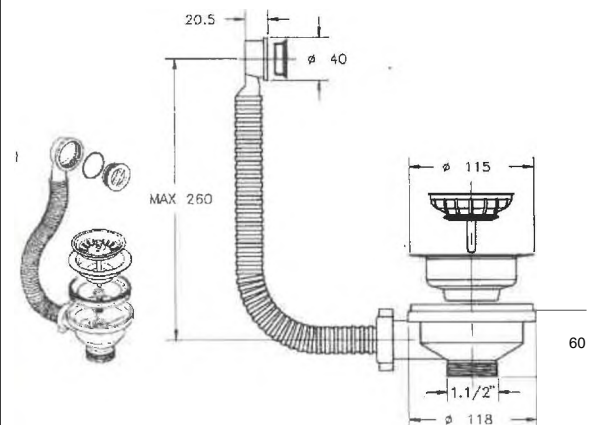

70425 PILETTA CTP RETT §90 INOX BON Art. 1922LX6480 P/C.1

70426 PILETTA S/TP §90 CERAMICA BON Art. 192113(64130 P/C.1

### Tappi Per Pilette Di Scarico C/Catenella



### TAPPI PER PILETTE

Completo di coprlforo e catena a perline da 25 cm in gomma nera. Ø disponibili: 27/31/35 mm. Confezionati singolarmente. Confezioni da 25 pezzi.

74804 TAPPO COMPLETO § 27 NERO MAV ArL 0035327N P/C. 50

74805 TAPPO COMPLETO § 31 N LEO Art. 1022 P/C. 50

74806 TAPPO COMPLETO § 35 N LEO Art. 1023 P/C. 50

74807 TAPPO COMPLETO § 40 N LEO Art. 1024 P/C. 50

74808 TAPPO COMPLETO § 47 NERO MAV Art. 0035347N P/C. 20

74809 TAPPO COMPLETO § 52 NERO mimi Art. 0035352N INC. 20



**Tappo Con Coperchietto Cromato E Catenella**



Tappi di gomma morbida; resistenti all'acqua calda, alle soluzioni sodiche e grasse; con catena a perline e rosetta inox

- 75250 TAPPO COMPL GOMMA/CR • 27 LEO Art. 1031 P/C. 50
- 75251 TAPPO COMPI, GOMMA/CR § 31 LEO Art. 1032 P/C. 50
- 75252 TAPPO COMPL GOMMA/CR § 35 LEO Art. 1033 P/C. 50
- 75253 TAPPO COMPL GOMMA/CR § 40 LEO Art. 1034 P/C. 20
- 75254 TAPPO COMPL GOMMA/CR § 47 LEO Art. 1036 P/C. 20
- 75255 TAPPO COMPL GOMMA/CR § 52 LEO Art. 1037 P/C. 20

**Rubinetto Ottone A Bocca Di Leone C/Portagomma**



Ottone lucidato e ossidato. Particolarmente adatto per fontane e vasche all'aperto. Ha in dotazione un portagomma da sostituire al rompigitto in caso di necessità.

- 46540 RUBIN SF BOCCA LEONE 1/2 MAV Art. 00147 P/C.12

**Rubinetto Comuni**



- 74812 RUBINET. COLLO OT7' CR 1/2 MAV Art. 016101 P/C.12



- 74813 RUBINETTO PULSANTE OT 1/2 MAV Art. 023531 P/C.1

**Rubinetto Ottone Lucido Giallo C/Portagomma**



1.4 3i4"  
133

Miditiv! -1  
t. 4.1. 4N  
al.  
grifi;

Caratteristiche tecniche  
Adatto ad ogni tipo di impianto  
teirauhrrt riscaldamento.  
Ideale per acqua calda fredda.  
Temperatura "urli TI; e  
d e)rcriziu.  
acqua: ti C 90 C.  
nera !,ritura ,dei-  
rt c cronata--.;uniata  
mi : ur• ua 318' -1.2"-3/4"-1  
Attacco tlettaxo: ISO  
DIN 259 85 2779.

- 46521 RUBINETTO C/PORTAG LUC 3/8 ITA Art. 3550038L P/C.12
- 46522 RUBINETTO C/PORTAG LUC 1/2 ITA Art. 3550012L P/C.12
- 46523 RUBINETTO C/PORTAG LUC 3/4 ITA Art. 3550034L P/C.12
- 46524 RUBINETTO C/PORTAG LUC 1 ITA Art. 3550100L P/C.12

**Rubinetto Ottone Giallo C/Portagomma**



'DN	8	C	0	01	'DNI	CRa i GR
31s"	97	20		11	13	16 9_1252
	111	120	46	14	14	16 :3
314"	138	169	51	19	20	1" 19 15 496
1,1	154	165	51	25	25	1"1/41 22 17 715

It

- 46532 RUBINETTO C/PORTAG OTT 1/2 RIG Art. 2322.015P/C.12
- 46533 RUBINETTO C/PORTAG OTT 3/4 RIG Art. 2322.020 P/C.12



**Rubinetti P/Gomma Ottone  
Enolgas Eko**



2212222				
1232,2	10	le	125	
8 n-	rt	se	50	
C re-	r	•	6	
frin	%			
E		5'	6'	
grt	1	14	195	27
a		63	63	al
E KO	H mi	8	102	122
8rbe5880 a s'era nrm %socio:in zirrh- gomma clar eva xta«	M	25	30	
Pz sul	tz	4	2	
can	22	72	54	
Peso q		283	372	'96'

- 48500 RUBINETTO SF PORT EKO 3/8** ENO Art. S.082.N.03 P/C.12
- 48501 RUBINETTO SF PORT EKO 1/2** ENO Art. S.082.N.04 P/C.12
- 48502 RUBINETTO SF PORT EKO 3/4** ENO Art. S.082.N.05 P/C.6
- 48503 RUBINETTO SF PORT EKO 1** ENO Art. S.082.N.06 P/C.4

**Rubinetti P/Gomma Ottone  
Enolgas Eko C/Lucchetto**



19lat,a			
A mm			
		14	
**		63	63
0		61	653
kl		16	
2	otss	10	12:
4		102	
EKO		25	30
9'er	se*	lo	
0	Pz un.	44	3'
	Peso qr.	398	49:

- 48536 RUBIN SF PORT/LUCCHET 1/2** ENO Art. S.074.N.04 P/C.10
- 48537 RUBIN SF PORT/LUCCHET 3/4** ENO Art. S.074.N.05 P/C.6

**Rubinetto P/Gomma Antigelo**



**Rubinetto portagomma rapido  
con maniglia a farfalla.  
Sabbaiato. Cromato.  
Misura: 1/2**

76601 RUB PORTAG C/MAN S/CRO 1/2 RMM Art. 19/BK.12 P/C.1

**Girelli Portagomma**

	Misura	3/4'	3/4'	1'	1'1/4
eA	98 mm	14,51	16	19,5	27
C mm		28	30	32	42
Pi.		50	50	25	25
Peso gr.		24	33	50	87

**EKO me**  
Portagomma e girano  
per rubinetto a sfera  
curvo, nichel\*.

- 48510 PORTAG/GIREL. x RUB SF. 3/8** ENO Art. S.083.N.03P/C.100
- 48511 PORTAG/GIREL. x RUB SE1/2** ENO Art. S.083.N.04P/C.50
- 48512 PORT,4G/GIREL. x RUB SE3/4** ENO Art. S.083.N.05P/C.25
- 48513 PORTAG/GIREL. x RUB SF. 1** ENO Art. S.083.N.06P/C.25





C.Mmon*	04	Srs	1/2	3/4
Mmen	134	134	143	155
	94	94	110	130
	55	53	65	65
	50	90	8e	55
	10	10	12	15
modemede	15	15	15	1a
yffirOe	720	220	270	170
air#	10	0	6	

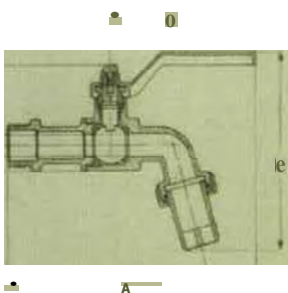

- 47101 RUBIN. SFER P/GOMMA 3/8 ITA Art. 1320038 P/C.12  
 47102 RUBIN. SFER P/GOMMA 1/2 ITA Art. 1320012 P/C.12  
 47103 RUBIN. SFER P/GOMMA 3/4 ITA Art. 1320034 P/C.6  
 47104 RUBIN. SFER P/GOMMA I ITA Art 1320100 P/C.6

**RUBinetti P/Gomma A Idrantino itap**

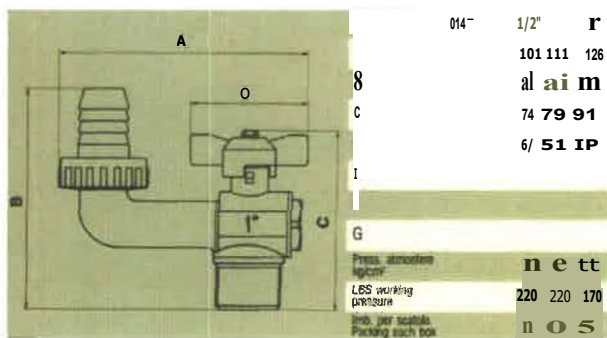

- 46302 RUBINETTO IDRANT.SFERA 1/2 ITA Art 1910012 P/C.10  
 46303 RUBINETTO IDRANT.SFERA 3/4 ITA Art 1910034 P/C.10  
 46304 RUBINETTO IDRANT.SFERA I ITA Art. 1910100 P/C.5

**Rubinetto Per Cassetta**



Mater — **Q Ottone**  
 stampato OT 58  
 vitone: Ottone OT 58  
 O-Ring vitone: Gomma 1h4811  
 àteligkeneApfit Gomma NBR

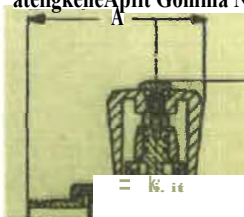

arrondi	1/4"
In rina	
A	
B	
C	
D	
E	
G	
Prim. loneelve'	18
w D. 10. m	
peS w rgerkine	230
rolaire=t	

- 76221 RUBIN. x CASSETTA CR 3/8 ITA Ari. 3750038 P/C.12  
 76222 RUBIN. x CASSETTA CR 1/2 ITA Art. 3750012 P/C.12

**Rubinetto Attacco Lavatrice**



Màlftt#1 - Corno: Ottone  
 stampato OT 58  
 yhpi: Ottone OT 58  
 Q&pAgi Gomma NBR  
 he Gomma N8R

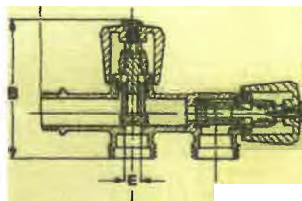

DimenstnI	114"318" 1/2"314"
In rinn	
A	140
e	72
C	45
O	
E	
F	
Pm *man	16
lq>tent	
LOS z.orking	230
pressLre	
let> >>Mb	6
ect, boe	

- 76200 RUBINETTO 2 AIT x LAY 1/2 ITA Art. 24000120 P/C.12



Materiali: Ottone OT 58  
 Vitone: Ottone OT 58  
 Guarnizione: Gomma NBR

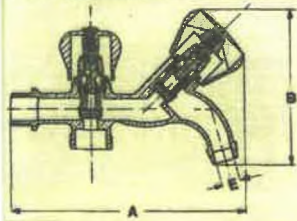

Dimensioni in mm	1/4" 3/8" 1/2"
A	120
B	85
E	10
F	
G	
Press. atmosf. Kcm	8
LBS working pressure	120
Pressure Int	12

76202 RUBINETTO DUP AT/LAVAT 1/2 ITA Art. 2200012U P/C.12



### RUBINETTO LAVATRICE A SFERA

Misura Pz. per Conf.  
 1/2 x 3/4 10

71404 RUB SF x LAVATR 1/2x3/4 CR EDR Art. 4.091 P/C.10



Materiali: Ottone stampato OT 58  
 Vitone: Ottone OT 58  
 Guarnizione: Gomma NBR

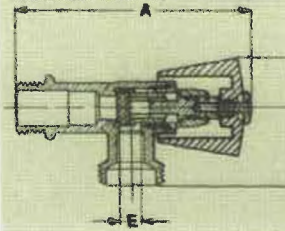

Dimensioni in mm	1/4" n" 1/2"
A	95 95
B	48 48
C	
D	
E	9 9
F	16 16
LBS working pressure	230 230
Pressure Int	12 12

76203 RUBINETTO SEMPL ORIZ 3/8 ITA Art. 2250038 P/C.12

76204 RUBINETTO SEMPL ORIZ 1/2 ITA Art. 2250012 P/C.12



Dimensioni in mm	1/4" 3/8" 1/2"
A	49
B	78
E	10
F	34
G	1.0
Press. atmosf. Kcm	7:10
LBS working pressure	6

Materiali: Ottone stampato OT 58  
 Vitone: Ottone OT 58  
 Guarnizione: Gomma NBR

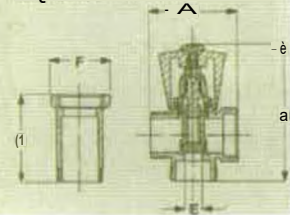

76205 DISTANZIAT.ATT.LAV 3/4 2PZ ITA Art. 23000340 P/C.12



Dimensioni in mm	1/4" 3/8" 1/2"
A	65
B	7
F	30
G	42
Press. atmosf. Kcm	18
LBS working pressure	110
Pressure Int	6

Materiali: Ottone stampato OT 58  
 Vitone: Ottone OT 58  
 Guarnizione: Gomma NBR

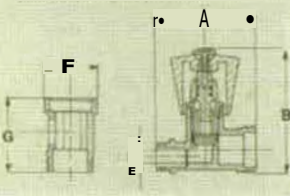

76206 DISTANZIAT.ATT/LAV 3/4 3PZ ITA Art. 23500340 P/C.12



76207 SOLO COPPIA PROLUNGHE ITA Art. 2370034 P/C.12





**Molatisi! • Co** Ottone  
stampato OT 58  
Niton: Ottone OT 58  
O-Ring Gomma NBR  
Guarnizione vitone: Gomma NBR

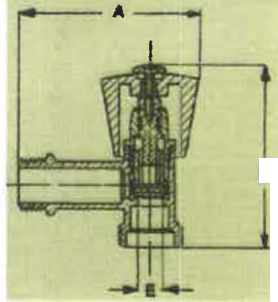

~inni in Jim	114" 3,8"
A	73 73
B	74
C	
D	
E	9 9
F	
G	
Paga timastere >> EU/	15 16
Lf4S working prssurn	230 230
pv sorda Packing 440 box	12 12

**76208 RUBINETTO SEMPL LAVATR 3/8** ITA Art. 2500038 P/C.12

**76209 RUBINETTO SEMPL LAVATR 1/2** ITA Art. 2500012 P/C.12



**Materi** 910/ Ottone  
stampato OT 58  
Vitone: Ottone OT 58  
O-Ring Ice; Gomma NBR  
Guarnizione vitone: Gomma NBR

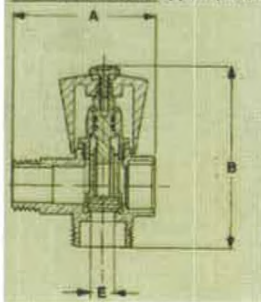

Conernm-- n MITS	1/4" 3/8" 112"
A	60 00
B	73 73
C	
D	
E	9 q
F	
G	
1:51ineeim	18 18
LBS working pressure	230 230
ILM	10 10

**76210 RUBINETTO 3V ATT LAV 1/2** ITA Art. 2550012 P/C.12



Umeneift  
in nvrts 114" 3i5" 112"

A	75
	52
E	9
F	
G	
Pmet ~sin	16
kdcmr	
LBS working pressure	230
rstk.pier scola nos. Jg. ceti box	12

14~ - etnyA: Orione  
stampato OT 58  
Vitone: Ottone OT 58  
O-ftingvitone:Gomma NBR  
Guarnizione vitone: Gomma NBR

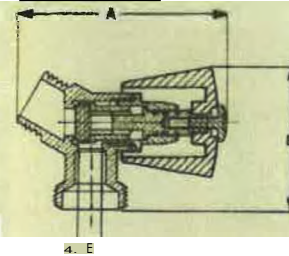

**76212 RUBIN. AT7' LAVAT INCL. 1/2**

ITA Art. 2280012 P/C.12

### Rubinetto Incasso Con Cappuccio



**76227 RUBIN. INCASSO CAP 1/2**

ITA Art. 3400012 P/C.6

**76228 RUBIN. INCASSO CAP 3/4**

ITA Art. 3400034 P/C.6

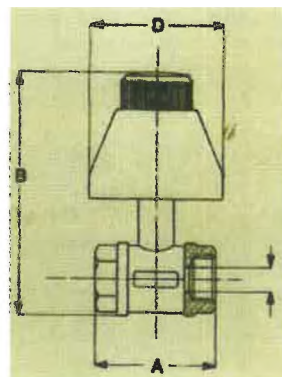

Olionolrol rrins	1/4" 3/8" 1/2" 3/4"
A	56 66
B	125 128
C	
D	63 63
E	15 20
F	
G	
Press. atmosfere kg/cm²	30 25
LBS working pressure	430 360
Imb. per scatola Packing each box	8 5

**47110 VALVOLA SF INC C/CAP 1/2**

ITA Art. 1360012 P/C.8

**47111 VALVOLA SF INC C/CAP 3/4**

ITA Art. 1360034 P/C.5

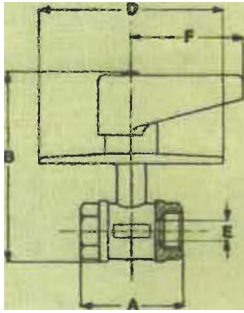

	1/4"	011'	312"	3M"	1"	1111'
A	56	66	82			
e	10	75	117			
C						
O	50	W	105			
E	15	20	25			
	EU	6	613			
G						
Plus orme. kAttr	30	95	21			
	430	360	360			
~ poni* eli un t"	5	5	5			

**47122 VALVOLA SF INC C/MAN 1/2** ITA Art. 1380012 PIC.8

**47123 VALVOLA SF INC C/MAN 3/4** ITA Art. 1380034 P/C.5



**76231 PROLUNGA x RUBIN INC C/CAP** ITA PIC.1

**76232 PROLUNG x RUB INC CAPP 1/2** ITA PIC.1



**76229 SARACINESCA INC C/CAPP 1** CIM Art. 71 P/C.10

## Rubinerro Cromato Da 112



MI11  
nomoato OT  
IMt Ottone OT  
0-rig" Gomma mak  
rtntv 60~11 18P

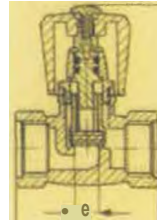

	1/4"	3/4"
		05
D		
hen ama«.		15
Siker>		.30
lagge.		12

**76234 RUBIN. ARR. SCALD CR 1/2** ITA Art. 3800012 P/C.12



## RUBINETTI PER SCALDABAGNO

Rubineti per scaldabagno istantaneo,  
tipo con canna rovesciabile.

Attacco 3/8".

In ottone cromato.

Confezioni da 2 pezzi.

**74871 GRUPPO SCALD + DADO 3/8 10** cu3 Art. 318-00000 P/C.1

## Areatori Per Rubinetti

# he

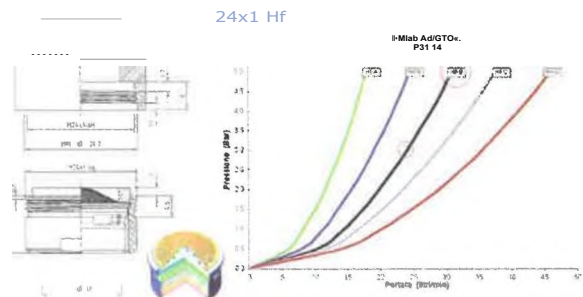

**74866AERATORE x LAV/BIDET M24X1** AMF Art. 1050553 P/C.10

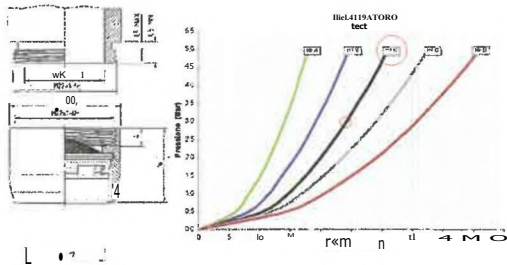

**74835 AERATORE x LAVELLO F 22x1** AMF Art. 1050052 P/C.10

**Fr/E 22x1**

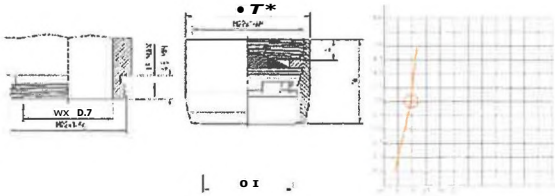

**74867 AERATORE PAS/RID FRE 22x1** AMF Art. 1050252 P/C.

**Fr/E 24x1**

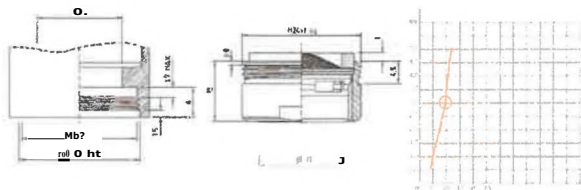

**74869 AERATORE PASIRID FRE 24x1** AMF Art. 1050752 P/C.



**Aeratore con snodo F** con IO

**74642 AERATORE CON SNODO F** MAV Art. 1108 P/C.10



**Aeratore con snodo M**

**74641 AERATORE CON SNODO M** MAV Art. 01108/A P/C.10

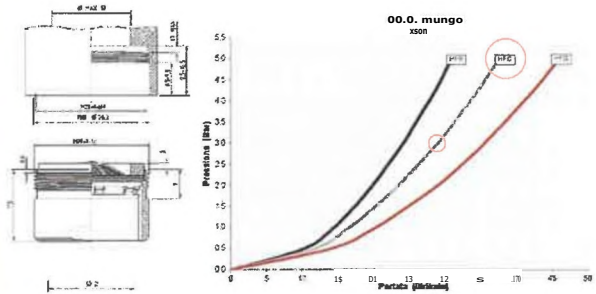

**74837 AERATORE x VASCA HFC 28 CR** AMF Art. 1051053 PIC.10



**DESCRIZIONE**

**MISURA** **1CONF.**

AERATORE FEMMINA 22(1 mm (Lavano) (Portata: 25 Itimln)

**58091 AERATORE F 22x1 OTTONATO** EDR Art. 692 P/C.10



**DESCRIZIONE**

**MISURA** **CONE**

AERATORE MASCHIO  
24x1 mm (Lavabo) Portata: 25 Itimln  
28x1 mm (vasca) Portata: 30 Itimln

**58092 AERATORE M 24x1 OTTONATO** EDR Art. 691 P/C.10

**58093 AERATORE M 28x1 OTTONATO** EDR Art. 691 P/C.10



Grazie al pratico adattatore **HIDROSELF**, in pochi secondi potrete collegare qualunque rubinetto ad una linea di raccordi FAST. Il kit comprende infatti, oltre all'adattatore per portagornna, due raccordi in ottone cromato con filettature diverse per adattarsi a più situazioni. Confezione in blister.

22865 ADATTUNIVERS.RUBINXP/GOM DNE Art. 2325 P/C. 10

**Vitone Ricambio Universale**



**KIT VITONE UNIVERSALE**  
Completo di prolunghe, riduzioni e valvoline.  
Imballo: 10 pezzi

**MANIGLIA AD OTTO PUNTE**  
in ottone cromato.  
Foro brocciato 8/24  
Imballo: 10 pezzi

74901 KIT VITONE UNIVERSALE TIR Art. 8103000L P/C.1

74902 MANIGLIA CR x KIT VIT UNIV TIR Art. 8025000C P/C.1



**CAPPUCCI IN OTTONE CROMATO**  
Foro con filetto d. 19  
Altezza: 24 mm (tipo normale)  
32 mm (tipo alto)  
Imballo: 10 pezzi

74903 CAPPUCCIO OTTCR H 24 mm TIR Ari. 8027000C24 P/C.1

74904 CAPPUCCIO OTTCR H 32 mm TIR Art. 8027010C32 P/C.1

**Mensoline Con Ancorette Fissaggio Vecchi Lavabi**



74879 COPPIA MENSOLINE INOX MAV Art. 01253 P/C 2

**Rubinetto A Passo Rapido Per Scarico Wc**



**PASSO RAPIDO AD INCASSO**

Misura	Pz. per Conf.
3/4	1
1	1

71410 650 RUB. PASSO RAP INT 3/4 EDR Art. 4.054 P/C. 1

71411 650 RUB. PASSO RAP INT I EDR Art. 4.055 P/C. 1

**Pezzi Di Ricambio Passi Rapidi**



74906 VITONE UNIV PAS RAP §26 TIR Art. 0704 02 00 P/C. 1

74907 VITONE MI/ PAS RAP §27 TIR Art. 0704 03 00 P/C. 1

74909 VITONE UNIV PAS RAP §29 TIR Ari. 0704 05 00 P/C. 1

## Scatoline Guarnizioni E Or Per Ricambi

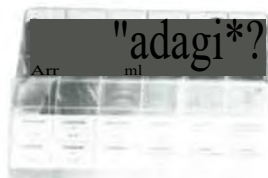

n	Ti. n°		i'L. I. imig.
Sanitarie		3/8"	40
Sanitarie		1"	4ii
Sanitarie		3/4"	40
Sanitarie			2o
Sanitarie		1,1/4"	6
Guar. per lavatrice		24x12x3	20
Gommini		3/8"	20
Gommini		1/2"	21
Commini		3/4"	10
Guar per canotti			5
Guar. per canotti		1"	
Guar per canotti		1,1;4"	5

74802 CONFEZ. GUARN.SANIT. ASSOR CLB Art. 145-00001 P/C.1



## ANELLI O'RING IN GOMMA NITRILICA

Scatola "Mignon" di anelli o'ring in gomma sintetica, rettificati per tenuta 720 °C, contenenti 425 pezzi nelle misure maggiormente richieste.

74803 CONFEZGUARNORING ASSORT. CLB Art. 144-00000 P/C.1

### Guarnizioni Per Flessibili E Raccordi Ottone



**GUARNIZIONI PER  
RACCORDI IN OTTONE  
Senza amianto  
Colore Verde**

75415	GUARNIZ S/AM x RACC OT 1/4	L-G	P/C.100
75416	GUARNIZ S/AAI x RACC OT 3/8	L-G	P/C.100
75417	GUARNIZ S/A M x RACC OT 1/2	L-G	P/C.100
75418	GUARNIZ S/AM x RACC OT 3/4	L-G	P/C.100
75419	GUARNIZ S/AM x RACC OT 1	L-G	P/C.100
75420	GUARNIZ S/AM x RA OT 1.1/4	L-G Art. 03SA11418	P/C.100
75421	GUARNIZ S/AM x RA OT 1.1/2	L-G Art. 03SA11218	P/C.100
75422	GUARNIZ S/AM x RA OT 2	L-G	P/C.100

## Guarnizioni Gomma Telate

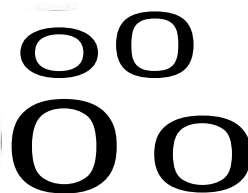

Guarnizioni gommate

70163	GUARNIZIONE COM/TELA 1/2	LEO Art. 1712	P/C. 100
70170	GUARNIZIONE GOM/TELA 3/4	LEO Art. 1713	P/C.100
70171	GUARNIZIONE GOM/TELA I	LEO Art. 1714	P/C.100
70172	GUARNIZIONE GOM/TELA 1.1/4	LEO Art. 1715	P/C.100
70173	GUARNIZIONE GOM/TELA 1.1/2	LEO Art. 1716	P/C.100

### Cordina Per Fare Guarnizioni



### NASTRO AL PTFE PER TENUTA FILETTI.

a

Rotoli trafilato PTFE autoadesivo per tenuta su flange o altre parti metalliche.

Sez. x lungh.: mm 5 x mm 2 x ml 20.  
Confezioni da 1 rotolo.

70199 CORDA AUTOADES PTFE 5x2x20 TIR Art. 797800PF P/C.1

### Guarnizioni Per 1 illtoni Del Rubinetti Tradizionali



Gomma morbida

75435	GUARN GOM SED/RUB FOR 3/8	LEO Art. 1661	P/C.100
75436	GUARN GOM SED/RUB FOR 1/2	LEO Art. 1662/G	P/C.100
75437	GUARN GOM SED/RUB FOR 3/4	LEO Art. 1663	P/C.100
75438	GUARN GOM SED/RUB FORAT 1	L-G	P/C.100

### Guarnizione Por illtoni Rispetti Da 1/2



Gomma rigida

74218 GUARNIZIONE x VITONE RAP Art. 0020071000 P/C.100

**Guarnizioni Per I Vitoni Dei  
Rubinetti Tradizionali Qualità Super**



In gomma extra-forte.

70159 GUARNIZ TENAX x RUBIN 3/8	LEO Art. 1621	P/C.100
70160 GUARNIZ TENAX x RUBIN 1/2	LEO Art. 1622	P/C.100
70161 GUARNIZ TENAX x RUBIN 3/4	LEO Art. 1623	P/C.100
70162 GUARNIZ TENAX x RUBIN 1	TIR Art. 1001000T1P/C.100	

**Set Composto Di 2 Guarnizioni  
Una Piana E Una Conica**



**Guarnizioni EXTRA**

75426 GUARN 2PZ GOMMA CON 1/2	L-G	P/C.1
75427 GUARN 2PZ GOMMA CON 3/4	L-G	P/C.1
75428 GUARN 2PZ GOMMA CON 1	L-G	P/C.1
75429 GUARN 2PZ GOMMA CON 1.1/4	L-G	P/C.1
75430 GUARN 2PZ GOMMA CON 1.1/2	L-G	P/C.1

**Set Composto DI 3 Guarnizioni  
Una Piana ,Una Conica E Una Metallica**

at



75431 GUARNIZ 3PZ x PILET 1/2	LEO Art. 1542	P/C.1
75432 GUARNIZ 3PZx PILET 3/4	LEO Art. 1543	P/C.1
75433 GUARNIZ 3PZx PILET 1	LEO Art. 1544	P/C.1
75434 GUARNIZ 3PZx PILET 1.1/4	LEO Art. 1545	P/C.1

Or Confezioni Da 5 Pzz.

**ANELLI O'RING  
IN GOMMA NITRILICA**

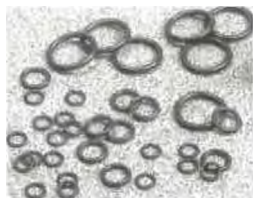

Misure mm	Pz. x conf.
5,7 x 1,9	5
6,4 x 1,9	5
7,2 x 1,9	5
12,1 x 2,7	5
13,6 x 2,7	5
15,1 x 2,7	5
18,77 x 1,78	5
27,8 x 3,6	5
34,1 x 3,6	5
37,3 x 3,6	5
36,1 x 3,53	5
37,3 x 3,6	5
44,45 x 3,53	5
58,74 x 3,53	5

Grti

70100 ANELLO OR 5.7X1.9 5PZ	TIR Art. 108500SR5	P/C.1
70102 ANELLO OR 6.4X1.9 5PZ	TIR Art. 108500SR5/A P/C.1	

70104 ANELLO OR 7.2X1.9 5PZ	TIR Art. R6	P/C.1
70106 ANELLO OR 12.1x2.7 5PZ	TIR Art. 108500SR10	P/C.1
70108 ANELLO OR 13.6x2.7 5PZ	TIR Art. 1085SFSR11	P/C.1
70110 ANELLO OR 15.1X2.7 5PZ	TIR Art. R12	P/C.1
70112 ANELLO OR 18.77X1.78 5PZ	TIR Art. OR2075	P/C.1
70114 ANELLO OR 27.8X3.6 5PZ	TIR Art. R21	P/C.1
70116 ANELLO OR 34.1x3.6 5PZ	TIR Art. 1087SFSR25	P/C.1
70118 ANELLO OR 36.1x3.53 5PZ	TIR Art. 1087.0R4143	P/C.1
70120 ANELLO OR 37.3x3.6 5PZ	TIR Art. 1087SFSR27	P/C.1
70122 ANELLO OR 44.45x3.53 5PZ	TIR Art 10870049)	P/C.1
70124 ANELLO OR 58.74x3.53 5PZ	TIR Art. 1087SFSR162	P/C.1

**imbuto Di Gomma Per Collegare  
Il Tubo Scendente Al Wc**



75466 IMBUTO PARA SEMPLICE CLB Art. 146.00000 P/C.50

**Morsetti Di Gomma Per  
Raccordare Il Scendente Al Wc**



Morsetto in gomma bianca per  
vaso tipo Standard  
Ø 60 x 30

75515 MORSETTO WC BIANCO 60 x 32 CLB Art. 151 -G6030 P/C.50



Morsetto in gomma  
bianca diam. esterno  
mm. 55 adattabile a  
canotti Ø 40-45  
diam. esterno mm. 60  
adattabile a canotti  
Ø 40-45

75516 MORSETTO WC BIANCO 55 x 40 CLB Art. 153-2001 P/C.50

75517 MORSETTO WC BIANCO 60 X 40 CLB Art. 153-2002 P/C.50



Morsetto maggiorato  
in gomma bianca  
Ø 55 x 30

75518 MORSETTO WC BIANCO 55 x 32 CLB Art. 150-M5530 P/C.50

Morsetto in gomma bianca  
Ø 50 x 30

75520 MORSETTO WC BIANCO 50x 32 CLB Art. 149-N5030 P/C.50



### Galleggianti Per Cassette



#### RUBINETTI A GALLEGGIANTE

**Attacco basso.**  
**Tipo silenzioso con**  
**=fina regolabile.**  
**Sede nylon.**  
**Attacchi: 3/8 - 1/2.**  
**Confezioni da 10 pezzi.**

**70167 GALLEGGIANTE ATT/BASSO 3/8 TIR** Art. 6495090L38 P/C.1



#### RUBINETTI A GALLEGGIANTE

**Attacco basso.**  
**Tipo silenzioso con**  
**ostina regolabile**  
**e rubinetto d'arresto.**  
**Sede nylon.**  
**Attacchi: 3/8 - 1/2.**  
**Confezioni da 10 pezzi.**

**70168 GALLEGG AT/BASSO C/RUB 3/8 TIR** Art. 6495100L38 P/C.1



#### RUBINETTI A GALLEGGIANTE

**Attacco alto.**  
**tipo silenzioso nichelato**  
**con astina in ottone ricotto.**  
**Sede acciaio.**  
**Attacchi: 3/8 - 1/2.**  
**Confezioni da 10 pezzi.**

**70169 GALLEGGIANTE ATT/ALTO 3/8 TIR** Art. 6496010N36 P/C.1



**70184 RUB.GALLEG. AST/DEF-SF 3/8 TIR** Art. 6803000L38 P/C.1

### Galleggianti



Asta tonda OT 63 per 3/8 - 1/2  
filetto sfera 1/4

Sede di tenuta inox



**76501 GALLEGGIANTE 5 COPP PR 3/8 S-T** Art. 274A1- 3/8 P/C.20



Asta piatta su 3/4 e  
per sfere cote scorrevole

Sede di tenuta inox

**76502 GALLEGGIANTE 5 COPP PR 1/2 S-T** Art. 274A1- 1/2 P/C.25

**76503 GALLEGGIANTE 5 COPP PR 3/4 S-T** Art. 274A2- 3/4 P/C.1



Sede di tenuta inox

Asta piatta su 1 1/2 - 1 1/2 - 2 - 2 1/2  
3 - 4 per sfere con scorrevole

**76508 GALLEGGIANTE 5 COPP 2.1/2 S-T** Art. 274A3-2.1/2 P/C.1



#### RUBINETTI A GALLEGGIANTE IN BARRA SILENZIOSI - SEDE INOX

Asta fissa  
3/8 - h 2 -



**76509 GALLEGG. SILENZ. INOX 3/8 S-T** Art. 215A- 3/8 P/C.25

**76510 GALLEGG. SILENZ. INOX 1/2 S-T** Art. 215A- 1/2 P/C.20



**PER USI INDUSTRIALI - IDRAULICI  
FUSI CONCHIGLIA**

MISURA  
\*S:ARICO  
ATM.  
LITRI  
MINUTO  
MISURA  
ASTA  
MISURA  
SF. IKAST  
MURA  
SF RASE

76528 GALLEGGIANTE INOX 3/4	S-T Art. 32018 3/4	<b>Mi</b>
76529 GALLEGGIANTE INOX 1	S-T Art. 320/B 1	P/C.1
76530 GALLEGGIANTE INOX 1.1/4	S-T Art. 320/B 1.1/4P/C.1	
76531 GALLEGGIANTE INOX 1.1/2	S-T Art. 320/B 1.1/2P/C.1	
76532 GALLEGGIANTE INOX 2	S-T Art. 320/B 2	P/C.1

AF' I nO



76511 SFERA PLASTICA PIATTA S-T Art 291- 90 P/C.1

CO.



76512 SFERA PLASTICA TONDA § 90 S-T Art. 293- 90 P/C.1

Sfere plastica tonda A.(71" SCOFWVt.:-)  
120 150 180 220



76513 SFERA PLASTICA TONDA §120 S-T Art. 295-120 P/C.1

# 49

Sfere in rame  
Ø 85 - 90 -100 con nottolino filetto 1/4  
Ø 120 - 150 - 180 - 200 - 220 - 250 - 280  
300 con scorrevole saldato

76514 SFERA RAME SALDATA § 85	S-T Art. 297- 85	P/C.1
76515 SFERA RAME SALDATA § 100	S-T Art. 297-100	P/C.1
76516 SFERA RAME SALDATA § 120	S-T Art. 297-120	P/C.1
76517 SFERA RAME SALDATA § 150	S-T Art. 297-150	P/C.1
76518 SFERA RAME SALDATA § 180	S-T Art. 297-180	P/C.1
76519 SFERA RAME SALDATA § 200	S-T Art. 297-200	P/C.1
76520 SFERA RAME SALDATA § 220	S-T Art. 297-220	P/C.1
76521 SFERA RAME SALDATA § 250	S-T Art. 297-250	P/C.1



76525 NOTTOLINO FIL 1/4 x SF RAM S-T Art. 120C1 P/C.1



**Cassette Con Scarico Alto**

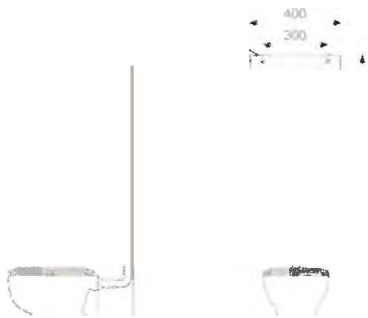

**78601 CERVO CASSETTA C/SIF-CAMP** IGP Art. PMV405 P/C.10

**78603 CERVO CASS SIF/CAM/PUL/GAL** IGP Art. pmvai oorrN/ P/C.1

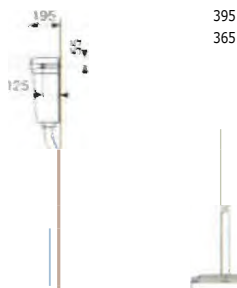

**78602 DAINO CASSETTA C/SIF-CAMP** IGP Art. PMD200 P/C.10

**78604 DAINO CASS SIF/CAWPUL/GAL** IGP M. pmceosarrNi PIC.1

**Accessori Per Cassette Igp**



PRIDC2 (669, eno per cassette ohe  
ribcddo Fui Dono • (ervo F52,1

**78702 DAINO CAMPANA**

IGP Art. PRIDC2 P/C 1

oiort ppeerr (cassette ahe  
A Dmno (erro

**78703 DAINO SIFONE**

IGP Art. PRIDC1 P/C. 1

L  
- **1,13**

gitlf94 (odo pee Itxgoo  
**Joe** o &Mena di Mie It  
rossetta ritte govnone

**78706 DAINO CONTRODADO**

IGP Art. PRIF04 P/C.1

PRIF09 L  
le cassetti  
meccanico  
e comparsi  
o viene e

**78707 DAINO LEVA C/PERNO**

IGP Art. PRF109N P/C.1

**78705 DAINO LEVA C/PERNO NUOVO**

IGP Art. PRIF09N P/C.



**78708 DAINO BUSTINA RICAMBI**

IGP Art. PRIDC3N P/C.1

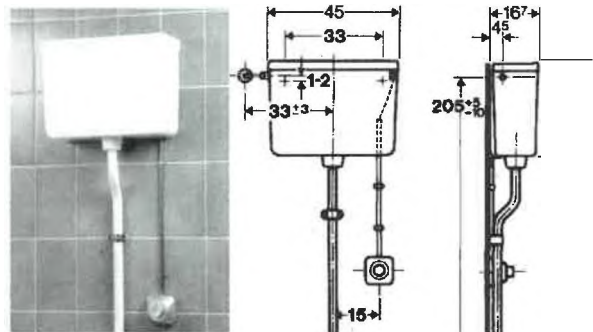

**79007 CASSETTA PNEUMC/COP L 10**

GEB Art. 123303.11 P/C.1

**Tirante Per Risciaequamento Cassette Alte**

6

4

74811 PULL COMPLETO M 1.20 B LEO Art. 1113 P/C.1

**Batteria Pneumatica Per Cassette Alta**

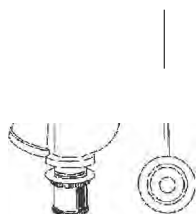

**Tipo Catis**

73030 BATTERIA x CASSETTA ALTA TRE Art. 159 P/C.1

**Tubi Di Cacciata >e 32 Per Cassette Alte**

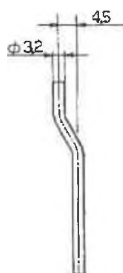

78720 TUBO DI RACC.CASS.x WC EST IGP Art. PAC100(A) P/C.1

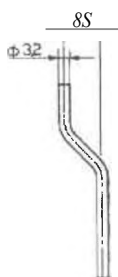

78721 TUBO DI RACCASS.x WC INC IGP Art. PAC101(B) P/C.1

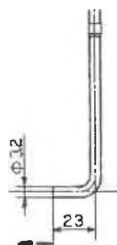

78722 TUBO DI SCARICO INF x WC IGP Art. PAC100(C) P/C.1



78723 TUBO DI SCARICO INFxTUR/I IGP Art. PAC1 03(D) P/C.1

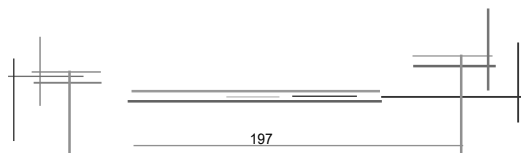

78730 TUBO DI SCAR INF DIRxTUR/E IGP Art. PAC102(E) P/C.1

**Sifone Per Turca**

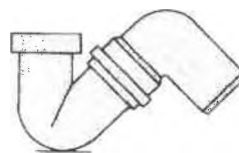

79473 SIFONE TURCA 45° A PER + ' OLV Art. 900653 P/C.1

**Cassette Kariba A Zaino**



44.5

79201 CASSETTA KARIBA BIANCA KAR Art. 325008 P/C.5



**Capacità di scarico 6/9 litri**  
**Coibentata contro il trasudamento**  
**Riempimento rapido e silenzioso**  
**Rumorosità inferiore a 12 DbA**  
**Possibilità di interruzione dello scarico (start/stop)**  
**Rubinetto di arresto cromato da 1/2"**  
**Galleggiante NORMA e valvola di scarico a norme NF-DIN**  
**Alimentazione tateana e dal basso destro sinistra, e posteriore**  
**Kit di fissaggio a parete, con accessori e dima**  
**Garanzia 10 anni**

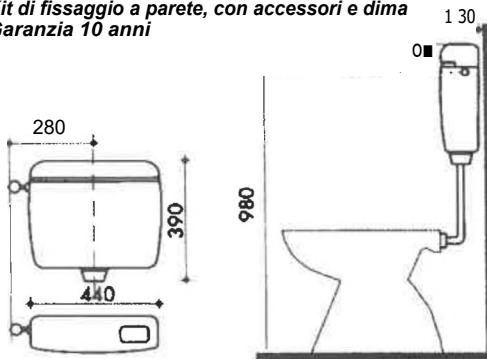

79203 CASSETTA SUPER KARIBA BIAN KAR Art. 334008 P/C.5

79204 CASSETTA SUPER KARIBA CHAM KAR Art. 334008CH P/C.5



Capacità di scarico 6/9 litri  
 Coibentata contro il trasudamento  
 Riempimento rapido e silenzioso  
 Rumorosità inferiore a 12 DbA  
 Possibilità di interruzione  
 dello scarico (start/stop)  
 Rubinetto di arresto cromato da 1/2"  
 Galleggiante NORMA e valvola di scarico  
 a norme NP-101N  
 Alimentazione laterale destra,  
 sinistra e posteriore  
 Kit di fissaggio a parete, con accessori e clima  
 Garanzia 10 anni

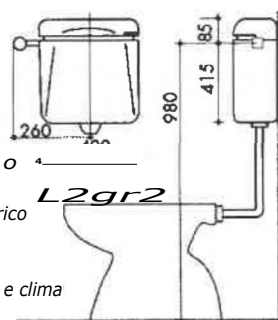

**79206 CASSETTA KARIBA LUX**

KAR Art. 335100 P/C.5



**cassetta senza pulsante  
 (da completare  
 con art. 79322 o 79318)**

**79200 CASSETTA KARIBA LUXPNEU**

KAR Art. 335130 P/C.5



Sistemi a funzionamento pneumatico di elevato affidabilità,  
 di semplice e rapida installazione per tutti i tipi di cassette.

**Comandi**

- nei Pneu incasso e a parete/pavimento viene dato in dotazione il tubetto in nylon+tubo corrugato di mt 2 e scatola incasso da murare
- nei Pneu esterni viene dato in dotazione il tubetto nylon do mt 2 + 3 tubetti rigidi da cm 50 e cavallotti, viti e tasselli

**79322 PULSANTE PNEU INCAS BIANCO** KAR Art. 400101 P/C.1

**79318 PULSAIVTE PNEU EST BIANCO** KAR Art. «mos P/C.1

«Lati

ar Mb ■ Mb MIA  
 ani mar ara



**Cassetta a zaino di linea nuova, moderna ed elegante con dimensioni e caratteristiche conformi ai più elevati standard europei. Dotata di meccanismo economizzatori a doppio comando per risparmio dell'acqua.**

**Capacità di scarico: completo: 6/9 litri  
 parziale: 3 litri**

Coibentata contro il trasudamento  
 Riempimento rapido e silenzioso  
 Rumorosità inferiore a 12 DbA  
 Rubinetto di arresto cromato da 1/2"  
 Galleggiante NORMA e valvola di scarico a norme NF-DIN  
 Alimentazione laterale destra,  
 sinistra e posteriore  
 Garanzia 10 anni  
 Colori: Bianco

**79202 CASSETTA TOP DUO § 40 BIAN**

KAR Art. 336200 P/C.

**Cassette Kariba Incasso**



Cassetta do incasso dalle innovative caratteristiche tecnologiche, progettata, realizzata con la tecnologia del soffiato quindi priva di saldature, costruito in conformità agli standards europei e protetta da diversi brevetti internazionali.

**Versione: 6/9 litri con rete o foderino antitrasudamento, 12 litri solo con rete**

Riempimento rapido e silenzioso  
 Rumorosità inferiore a 12 DbA  
 Possibilità di interruzione dello scarico (start/stop)  
 Rubinetto di arresto cromato da 1/2"  
 Galleggiante NORMA e valvola di scarico a norme NF-DIN  
 Garanzia 10 anni

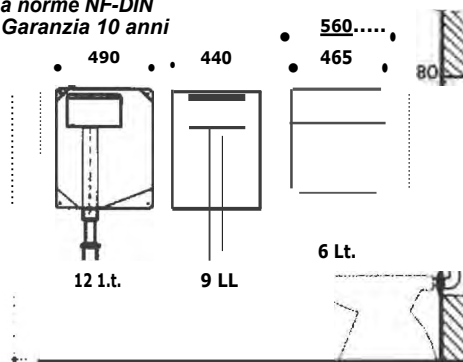

**79207 CASS INC 9L C/PLACCA/CANOT**

KAR Art. 365101 .305003

**Ricambi E Accessori Kariba**



**Bianca  
per cassette  
costruite fino al 1995**

**79324 PLACCA x CAS WC 9L x365101 KAR Art. 305003 - BI P/C.1**



**Bianca  
per cassette  
costruite dopo il 1995**

**79325 PLACCA NUOVA x CAS WC 9L KAR Art. 305203 - BI P/C.1**



Rubinetto galleggiante, omologato NF e DIN, prodotto su uno nuovo linea automatica integrata, che permette di stampare, assemblare e testare tutti i singoli pezzi prodotti.

**Riempimento rapido = 0,12 litri secondo, con alimentazione bocchettone 3/8"**

**Silenzioso: classe acustica I**

**Esami effettuati presso i laboratori CSTB - AFNOR 8**

**26.02.95**

**Possibilità di utilizzarlo con bocchettone da 1/2"**

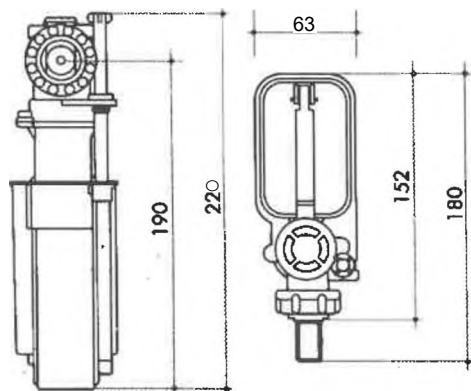

**79314 GALLEGG. UNIVERS.NORMA 3/8 KAR Art. 300384 P/C. 1**



**79303 RUBINETTO ARRESTO 3/8 CR KAR Art 300800 P/C. 1**

**79319 RUBINETTO ARRESTO 1/2 CROM KAR Art. 300801 P/C.1**



Per cassetta Kariba modello vecchio.

**79302 LEVA COMANDO CASSETTA KAR KAR Art. 314403 P/C.1**



**79327 PULSANTE-LEVA KAR/2005 BIA KAR Art. 300514**



**79312 LEVA x AARIBA KAR Art. 300512 P/C. 1**



**79310 LEVA COMANDO S/KARIBA KAR Art. 330021 P/C. 1**

**79313 GRUPPO PISTONCINO GALLEGG KAR Art. 314706 P/C. 1**

-0>

i 14.5

**79321 COPERCHIO x KARIBA 2005 BI KAR Art. 300606 P/C.1**



79323 COPERC C/PULS x KAR 2001 B KAR Art. 300608 P/C.1



79317 COPERCHIO C/PULS LUX KARI KAR Art. 335201 P/C.1



79320 COPERCHIO C/PULS x S/KARIB KAR Art. 330011 P/C.1



Tubo scomponibile 50 x 32 x 980 curvo 45°  
drena mediai:11M, bianco

79210 TUBO 2 PZ BIANCO KAR Art. 255353 P/C.25

79209 TUBO 2 PZ CHAMPAGNE KAR Art. 255351 P/C.25



Tubo 50 x 32 x 1000  
altezza media/alta, bianco

79211 TUBO 50/32x100 BIANCO KAR Art. 215313 P/C.25



Tubo 50 x 32 x 325 altezza normale, bianco

79213 TUBO SCAR 50x40x325 BIANCO KAR Art. 205433 P/C.25



Curva 90° con rosone per  
raccordo cassette alte e 32, bianco

79298 CURVA 90° C/ROS§32 CAS/AL KAR Art. 243326 P/C.1



79326 ANCORINA LUNGA SERIE 2001 KAR Art. 301153 P/C.1



79330 GRUP SOLLEV PNEUMATICO KAR Art. 400021 P/C.1



79340 POLMONE ESPANSIONE PNEUMAT KAR Art. nome



Per trasformare l'attacco § 50 della  
cassetta al tubo scendente di § 32

79300 DADO x CASSETTA KARIBA §30 KAR Art. 410067 P/C.1



Completo di guarnizioni.

79301 DADO CASSETTA KARIBA B KAR Art. 214031 P/C.1

79304 GUARNIZIONE DADONE KAR Art. 114005 P/C.1

79309 ANELLO SLITTAMENTO KAR Art. 114007 P/C.1



Adattatore per trasformare  
lo scarico di § 50 in § 32  
per tubi scendenti

79299 DADONE CANOTTO §32 C/GUARN KAR Art. 214032 P/C.1

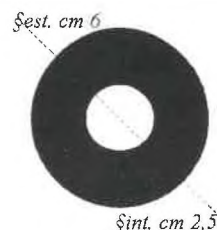

GUARNIZIONI PER STRAMAZZO KARIBA

79305 = ø est. 78 mm - ø int. 20 mm

79307 = ø est. 60 mm - ø int. 23 mm

79308 = ø est. 60 mm - ø int. 19 mm

79305 GUARNIV. VALV SCAR. 78X20 KAR Art. 114017 P/C.50

79307 GUARN. VALV SCAR. 60X23 KAR Art. 410070 P/C.50

79308 GUARNIZIONE FONDO 60x19 KAR Art. 112151 P/C.50



**79306** GUARIV. VALV. SCAR. TIPO NUOVO **KAR** Art. 112152 P/C. 1



+1L ji

**79315** VALVOLA SCARICO TIPO NUOVO **KAR** Art. 300162 P/C. 1

*Per chiudere attacco laterale dove non vi è il galleggiante.*

**79316** TAPPO LATERALE x SUPERKAR **KAR** Art. 300701 P/C. 1



**79311** GRUPPO FORCELLA **KAR** Art. 300500 P/C. 1

**Cassette Oliver A Zaino**



Cassetta per fissaggio a muro In posizione bassa o a media altezza. Viene prodotta nella "versione" originale corredata di rubinetto JOLLY UNI e valvola di scarico "in un solo pezzo" azionata da pulsante o doppio effetto per rinterruzione dello scarico.

E' un prodotto di gamma medio-alta già fabbricato in elevato numero di esemplari con esperienza trentennale e con rapporto prezzo qualità estremamente vantaggioso



**79501** CASSETTA SMERALDO BIANCA OLV Art. 401201 P/C. 5



Modello da parete (re) posizione (X) 1.5.5.1. Merit  
la sua linea oggi in standard Europea, si adatta armonicamente in ogni situazione di "Arreda-in-mina"  
E' dotata di "meccanismi" Olive, di assoluta affidabilità  
Il doppio pulsante permette lo scarico automatico o l'interruzione della stessa consentendo un'azione sensibile ed economica.  
Garanzia 10 anni



**79503** CASSETTA TOPAZIO BIANCA **OLV** Art. 411201 P/C. 5



**79502** CASSETTA TOPAZIO NEW98 BIA OLV Art. 416201 P/C. 5

(\*J)  
**OLIVER INTERNATIONAL**





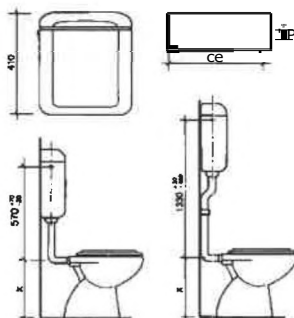

**CASSETTA 01 RISCIAQUAMENTO 8/9 LITRI PER INSTALLAZIONE A PARETE A BASSA E MEDIA POSIZIONE.**  
 Cassetta di tipo tradizionale: elegante, di elevata qualità e a basso consumo d'acqua grazie al pulsante basculante che consente l'interruzione dello scarico per piccole erogazioni d'acqua.  
 - Silenziosa, efficace nel lavaggio e nella velocità di scarico (circa 2,2 litri/sec.).  
 - Isolata contro la condensa.  
 - Spessore 18 cm.  
 - Garanzia totale di 10 anni.  
 - A norme DIN 19542.  
 - Rubinetto d'arresto unificato (tre in uno).  
 - Rubinetto galleggiante classe unificata INF.  
 - Regolazione della quantità d'acqua di risciacquo sul rubinetto galleggiante (8/9 litri).  
 Con la sostituzione della valvola con quella pneumatica (cod. 520800) si può rendere la cassetta già installata pneumatica.

**79500 CASSETTA ZAFFIRO .55' 40 BIAN** OLV Art. 430201 P/C.5

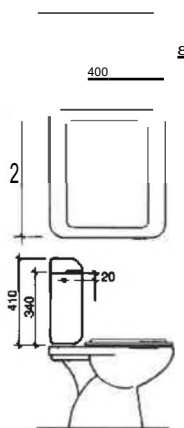

**CASSETTA DI RISCIAQUAMENTO MONOBLOCCO PER TUTTI I VASI IN CERAMICA - 6/9 LITRI.**  
 Cassetta elegante, di elevata qualità e a basso consumo d'acqua grazie al pulsante basculante che consente l'interruzione dello scarico per piccole erogazioni d'acqua. Appositamente studiata per l'allacciamento a tutti i vasi in ceramica.  
 - Silenziosa, efficace nel lavaggio e nella velocità di scarico (circa 2,2 litri/sec.).  
 - Isolata contro la condensa.  
 - Spessore limitato a 16 cm.  
 - Garanzia totale di 10 anni.  
 - A norme DIN 19542.  
 - Rubinetto d'arresto unificato (tre in uno).  
 - Rubinetto galleggiante classe unificata INF.  
 - Regolazione della quantità d'acqua di risciacquo sul rubinetto galleggiante (6/9 litri).  
 Con la sostituzione della valvola con quella pneumatica (cod. 520800) si può rendere la cassetta già installata pneumatica.

**79512 CASS MONOBLOC ZAFFIRO EST OLV** Art. 420001 P/C.5



**OLIVER INTERNATIONAL**

## Cassette Oliver Alta

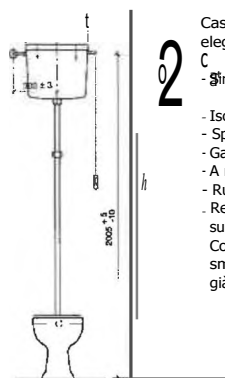

**Cassette ad alta posizione di tipo tradizionale: elegante e di elevata qualità con azionamento a tirante.**  
 - Silenziosa, efficace nel lavaggio e nella velocità di scarico (circa 2,2 litri/sec.).  
 - Isolata contro la condensa.  
 - Spessore limitato a 14 cm.  
 - Garanzia totale di 10 anni.  
 - A norme DIN 19542.  
 - Rubinetto galleggiante classe unificata INF.  
 - Regolazione della quantità d'acqua di risciacquo sul rubinetto galleggiante (8/9 litri).  
 Con l'applicazione della valvola pneumatica (cod. 520800) si può rendere la cassetta già installata pneumatica.

**79510 CASS ALTA TURCHESE + RUB B ouf** Art. 440201 P/C.5

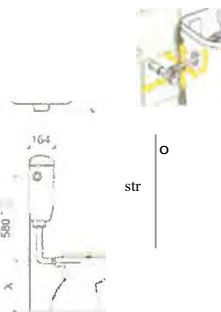

**CASSETTA DI RISCIAQUAMENTO 3 6 LITRI 37.5 LITRI PER INSTALLAZIONE A PARETE A BASSA E MEDIA POSIZIONE CON POSSIBILITÀ DI SCEGLIERE TRA 2 QUANTITÀ D'ACQUA.**  
 Cassetta di tipo tradizionale, elegante di elevata qualità e a basso consumo d'acqua grazie al doppio pulsante che consente di scegliere la quantità d'acqua per il risciacquo (3.6 - 3.7.5 litri).  
 - Silenziosa, efficace nel lavaggio e nella velocità di scarico (circa 2.2 litri/sec.).  
 - Isolata contro la condensa.  
 - Garanzia totale di 10 anni.  
 - A norme DIN 19542.  
 - Rubinetto galleggiante classe unificata INF.  
 - Regolazione della quantità d'acqua di risciacquo sulla valvola (scarico regolabile 3.6 litri • 3.7.5 litri).  
 • Allacciamento laterale DX SX regolabile

**Pred sposta per attacco basso e posteriore**

**79504 CASSETTA HAVANA DUE** OLV Art. 386201 P/C.1

### Ricambi Oliver



**79514 KIT LEVA + PULL x TURCHESE** OLV Art. 493140 P/C.1



**79515 ANCORINA PER CASS TURCHESE** ou Art. 493331 P/C.1

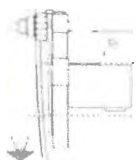

6 litri

• rd

9 litri

Il rubinetto galleggiante è fornito da OLIVER INTERNATIONAL regolato a 9 litri, per un risciacquo di solo 6 litri bisogna regolare l'altezza del medesimo.

**79519 RU8 GALLEG X TURCHESE 3/8** OLV Art. 560200 P/C.1

### Cassette Faismilani

- CESTELLO E COPERCHIO: in plastica faesilica antiurto.
- BATTERIA DI SCARICO: in plastica tipo aletta.
- DIMENSIONI: larghezza 470 mm - altezza 360 mm - spessore 190 mm.
- BOCCHETTONE DI USCITA: 0 interno 47 mm.
- SCARICO UTILE: 12 litri
- VELOCITÀ DI SCARICO: 5" a tubo libero.
- TUBO DI SCARICO: plastica, bianco o cromato, compreso nella confezione.
- ATTACCO IMMISSIONE ACQUA: laterale alto destro o sinistro.
- RUMOROSITÀ: norme UNI.

**78410 CASSETTA ANGOLO RENO PL B** FAI Art. 5360110 P/C.2



- CESTELLO E COPERCHIO: in plastica
- BATTERIA DI SCARICO: in plastica tipo aletta
- DIMENSIONI: larghezza 440 mm - altezza 340 mm - spessore 110 mm.
- BOCCHETTONE DI USCITA: e interno 47 mm.
- SCARICO UTILE: 11 litri.
- VELOCITÀ DI SCARICO: 5" a tubo libero.
- TUBO DI SCARICO: plastica, bianca o cromata, compreso nella confezione.
- ATTACCO IMMISSIONE ACQUA: laterale alto destro o sinistro.
- RUMOROSITÀ: norme UNI.

**78403 CASSETTA TAGO PLAST ABS B** FAI Art. 5330110 P/C.1



- CESTELLO: monoblocco in polistirolo faesilico antiurto ad elevatissimo grado di isolamento termico.
- DIMENSIONI: larghezza 420 mm - altezza 600 mm - spessore 75 mm.
- BOCCHETTONE DI USCITA: o interno 40 mm.
- SCARICO UTILE: regolabile da 10 a 14 litri.
- VELOCITÀ DI SCARICO: 6" a tubo libero.
- ATTACCO IMMISSIONE ACQUA: alto sinistro o destro.
- PLACCA DI COPERTURA: regolabile ed adattabile agli spessori di rivestimento fino a 40 mm.
- RUMOROSITÀ: norme UNI.

**78402 CASSETTA DORA PLASTICA** FAI Art. 5070110 P/C.1

### Ricambi Faismilani



**78507 GALLEGGIANTE COMPLETO TAGO** FAI Art. 3.220.110 P/C.1



**78541 TUBO PLASTICA TAGO L.60** FAI Art. 1220120 P/C.1



**75550 STRAMAZZO TAGO** LEO Art. 1294 P/C.25

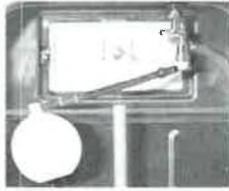

**75540 GALLEGGIANTE DORA** FAI Art. 3220010 P/C.1



**75542 STRAMAZZO DORA** LEO Art 1275/B P/C.25

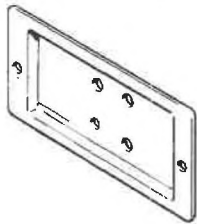

*Per cassetta Dora*

**78395 PLACCA INT x DORA P80 BIANC** FAI ArtL 3730015 P/C.1



**PLACCA OI COPERTURA:**  
Regolabile ed adattabile agli  
spessori di rivestimento

**78397 PLACCA PL.x DORA P80 BIANC** FAI Art. 3680010 P/C.1



**75541 PLACCA INT. DORA C/PULSANT CL.B** Art. 120-0000 P/C.1



*Per cassetta Dora*

**78349 PULS. PLAST.DORA CROMATO** FAI Art 365p170 P/C.1

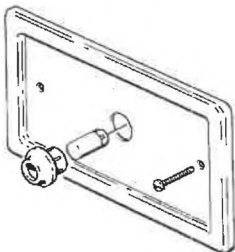

*Per cassetta Dora*

**78358 PLACCA PLAST x DORA BIANCA** FAI Art. 3670010 P/C.1

**78396 PLACCA PLASTICA CHAMPAGNE** FAI Art. 3670140 P/C.1



*Per cassetta Dora*

**78361 VITE x PLACCA** FAI Art. 1280210 P/C.1



*Per cassetta Dora P80*

**78399 PROLUNGA P80** FAI Art. 3250410 P/C.1



*Sfera tipo Dora*

**78385 PALLINA PARA X CASS. DORA** LEO Art. 1273/B P/C.1



**78370 ESTRAITORE UNIVERS x DORA** FAI Art 8550005 PIC.1

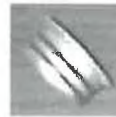

*Per cassetta Dora*

*Piccolo § 40 mm  
Grande § 42,5 mm*

**78386 INSERTO x DORA PICCOLO** FAI Art. 1270010 P/C.1

**78398 INSERTO x DORA GROSSO** FAI Art. 1270015 P/C.1



*Per cassetta Dora*

**78348 IMBUTO PLASTICA CROMATO** FAI Art. 3650110 P/C.1



*Per cassetta Tago*

**74920 GRUPPO PULSANTE RETI** FAI Art. 26860101 PIC.1

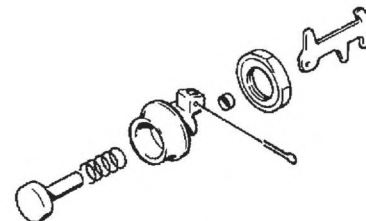

**78528 GRUPPO PULSANTE TONDO** FAI Art 3770015 P/C.1

**O** *Per TAGO EXPORT in lamiera*

**78519 GUARNIZIONE PARA FONDELLO** FAI Art. 1340010 P/C.1



*Cassette Pucci*



**78002 CASSETTA PUCCI RAME L 14** PUC Art. 1214 P/C.1



**78005 CASSETTA PUCCI L 14** PUC Art. 60421440 P/C.1

*Ricambi Pucci*



**75536 GALLEGGIANTE COMPL. PUCCI CLB Art. 132-09150 P/C.1**

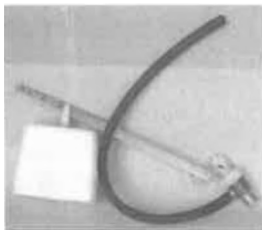

**78009 GALLEGGIANTE COMPL T.NUOVO PUC Art. 9151 P/C.1**

**78011 PLACCA BIANCA PER PUCCI** CLB Art. 132-09066 P/C.1



**75538 PISTONCINO x CASS PUCCI** CLB Art. 132-09115 P/C.10



**75533 PULSANTE COMPLETO PUCCI CLB Art. 132-09034 P/C.1**

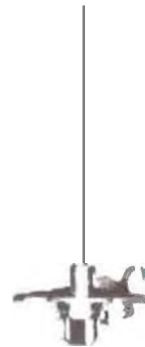

**75530 ESTRATTORE PER CASS. PUCCI CLB Art. 132-00001 P/C.1**

**75531 CONF.PUC.GAMBET-DADI-PAST** CLB Art. 132-09028 P/C.10

**Placca completa di telaio  
con rosone filettato,  
bottoni e prolunga fino  
a cm 3, bianco**

**78010 CONF. PLAC/ROS/BOT/PROL BI** PUC Art. 80007510 P/C.1



**75532 ROSONE E BOCC. CROMPUCCI** CLB Art. 132-09033 P/C.1





**75534 CONF.SFERA TENUTA PUCCI** CLB Art. 132-09039 P/C.1



**75535 SPORTELLO INT.SCAR.00 PUCC** CLB Art. 132-09076 P/C.1



**Accessori di gomma per cassetta Pucci**

**74801 SET GUARNIZIONI PUCCI** LEO Art. 1213 P/C.1

**O** Accessori di gomma per cassetta Pucci  
**1212 - Anello di tenuta di gomma**

**Note: sacchetti** di plastica polietene da 100 pezzi.

**75546 GUARNIZIONE FONDO x PUCCI** LEO Art. 1212 P/C.1

**e** § est. 19 mm.  
 Per Pucci e Dora

**78336 GUARNIZIONE A SCODELLINO** FAI Art. 1340910 P/C.100

**Cassette Geberit A Zaino**

**■ GEBERIT**

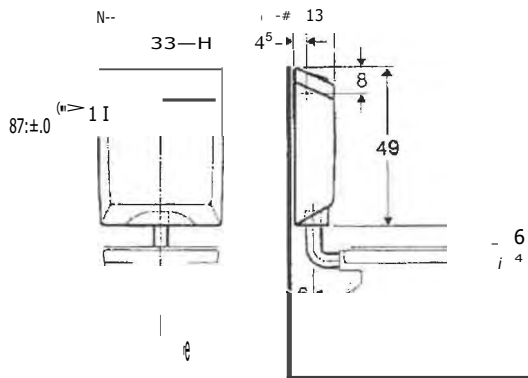

**79002 CASSETTA ESTERNA BIAN** GEB Art. 123001.11 P/C. 1

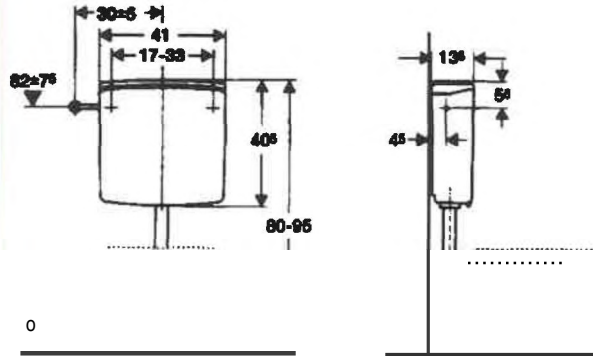

**79082 CASSET EST 6/9 LT CHAMPAGN** GEB Art. 140301.39 P/C.1

**Cassette Geberit Incasso**

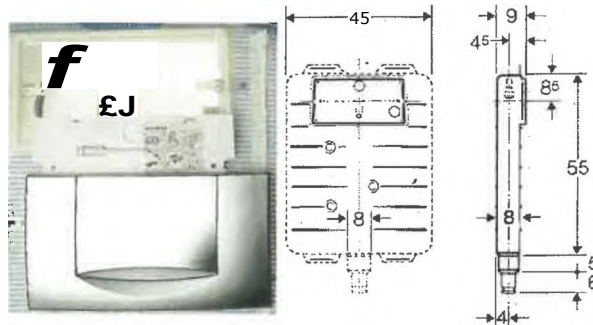

**79011 CASSETTA INCAS. L 10 C/TUB** GEB Art. 110700.00 P/C.1

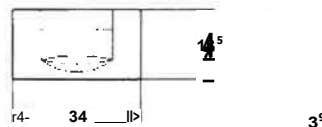

**Placca di copertura con tasto di comando**  
 Consente l'interruzione del risciacquo.

**79126 PLACCA BIANCA 1 COMANDO** GEB Art. 115294.11 P/C.1

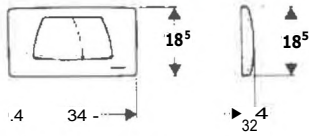

**Placca di copertura  
con doppio tasto di comando**

79125 PLACCA BIA. X 110700 2 COM GEB Art. 115894.11 P/C.1

79128 PLACCA CROMOSAT. X 110700 GEB Art. 11589445 P/C.1

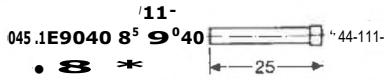

79012 CANDITO ALLAC. VASO BIANCO GEB Art. 118026.11 P/C.1

79013 CANOTTO ALLAC. VASO CROMAT GEB Art. 118026.21 P/C.1

**Combifix Montaggio Sanitari Sospesi**

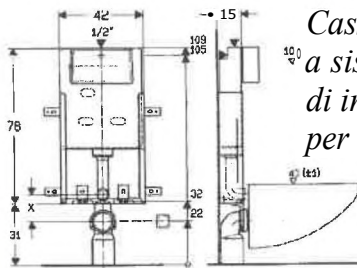

*Cassetta combinata  
a sistema  
di installazione pronto  
per wc sospesi.*

79000 COMBIFIX x VASO SOS

GEB Art. 110850.00 P/C.1

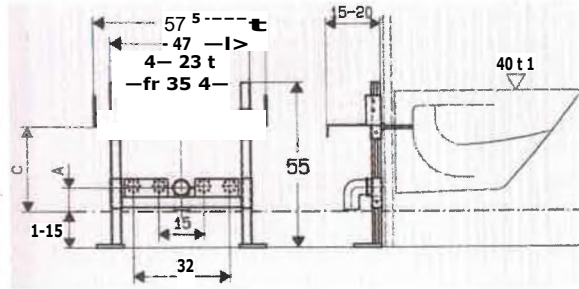

79001 COMBIFIX x BIDET

GEB Art. 457800.00 P/C.1



*Staffe di sostegno per combifix  
registrabili in altezza.*

79102 SUPPORTI x COMBIFIX

GEB AI. 457872.26 P/C.1

**Ricambi Geberith**



79143 COMANDO MANUALE PNEUMATICO GEB Art. 115440 Inc.1

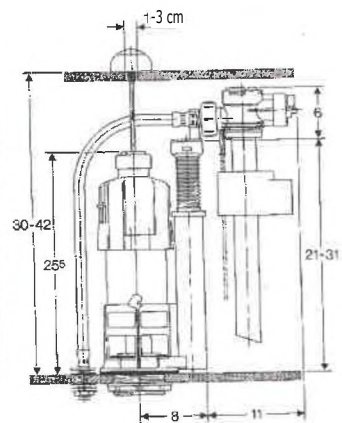

79099 BATTERIA x CASSET UNIVERS

GEB Art. 240158.21 P/C.1



*Adatta per cassette Incasso  
mod 110700 costruite prima  
del 1990. NO Mica*

79163 CAMPANA x CASS.110700

GEB Art. 215299.00 P/C.1



**Campana per cassette GEBERIT alta posizione prodotte tra il 1977 e il 1984**

**79161 CAMPANA COMPL. TELESCOP.** GEB Art. 240113.00 P/C.1



**Per Eurostar**

**79159 CAMPANA COMPLETA x EUROSTA** GEB Art. 890095.00 P/C.1



**Campana per cassette GEBERIT alta posizione mod. 123.300 prodotte dal 1993 in poi**

**79160 CAMPANA C/BACIN x CASS 123** GEB Art. 889992.00 P/C.1



25  
+14-16<sup>s</sup> → l

**Per vaso scarico a parete.**

**79100 ROSONE BIANCO 110** GEB Art. 242026.11 P/C.1

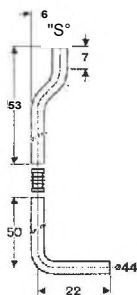

**Per montaggio cassetta esterna rialzata.**

**79190 TUBO RISCIAQUO BIANCO** GEB Art. 119097.11 P/C.1



**79153 GUARNIZ. CAMPANA DM 63x32** GEB Art. 816418.00 P/C.10

**79155 GUARNIZ. CAMPANA DM 58x32** GEB Art. 816179.00 P/C.10

**79157 GUARNIZ. CAMPANA DM 63x23** GEB Art. 891015.00 P/C.10



**Per cassette ad incasso**

**79095 RUBINETTO GALLEGG.x110700** GEB Art. 240077 P/C.1



**Per cassette ad incasso ed esterne. Con kit di montaggio dx,sx e posteriore Sostitutivo Uniti! 215419**

**79096 RUBINETTO GALLEGGIANTE** GEB Art. 240112 P/C.1

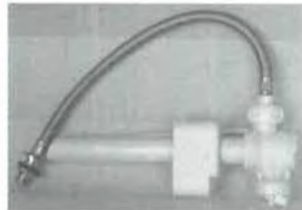

**Per tutte le cassette esterne e ad incasso. Detto: Nuovo Uniti! Universale**

**79097 RUBINETTO GALL COMPL 3/8** GEB Art. 215419.00 P/C.1

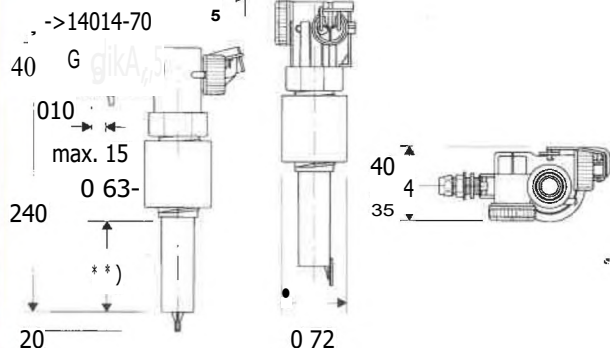

**74712 VALVOLA CARICO**

GROArt 37095 P/C.1

## Ricambi Per Cassette Stil-Blitz

75548 *PLACCA EST BIA STIL-BLITZ* **CLB** Art. 126-00003 P/C.1

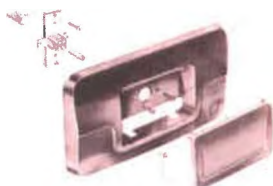

75549 *PLACCA KIT EST STIL-BLITZ* **CLB** Art. 126-00001 P/C.1



75543 *PULSANTE STIR-BLITZ* **CLB** Art. 124-00000 P/C.1

75544 *GALLEGGIANTE STIR-BLITZ* **CLB** Art. 130-00000 P/C.1



Asta c/sfera 141t SBV

75545 *STRAMAZZO STIR-BLITZ* **CLB** Art. 116-0000V P/C.25

### Ricambi Per Cassette Ramo



**Valvola di gomma para  
per cassetta Ramo**

75560 *SFERA x CASSETTA RAMO* **LEO** Ai1. 1291 Re 1



Rubinetto galleggiante per cassette incasso tipo "R"  
completo di sfera, o/attacco da 3/B"

75557 *GALLEGGIANTE COMPL. RAMO* **CLB** Art. 131-000R1 P/C.1

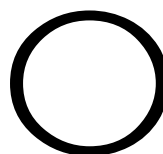

70157 *MEMBRANA x BATTERIA MON.* **TIR** Art. 208500PN P/C.1

## GUARNIZIONI A SCODELLINO

e  
se  
e.  
ce

0	Pz. x
18	100
17	100
18,5	100
21	100
23	100
24	100

**Per rubinetti a galleggiante.  
In gomma morbida.**

**Colore: rosso**



70174 *SCODELL. §23* **TIR** Art. 152200GR23 P/C.100

## GALLEGGIANTE SFERA DI TENUTA

**In para rossa.  
= 68 mm.**

**Nottolino ottone filetto 5/32"  
Confezioni da 24 pezzi.**

70188 *SFERA TENUTA CYNOTTOLINO* **MAV** Art. 00013 P/C.1



## FLAP IN PVC

**Con guarnizione in para.  
Completo di cordino.  
Confezioni da 24 pezzi. Milo'**

70189 *FLAP PVC x BATTERIA* **TIR** Art. 207300PB P/C.1



**Per vasi monoblocco  
completa di guarnizioni  
e tiranti. In plastica**

73001 *BATTERIA PNEUMATICA AZZURR* **IDN** P/C.1



**Batterie Di Scarico Per Cassetta Pneumatiche Todini**



**UNIBOX entrata laterale**

- Pulsante di comando pneumatico.
- Gruppo di scarico centrale,
- Rubinetto a galleggiante attacco laterale/posteriore.
- Tappo ABS cromato.
- comprese guarnizioni e viti per accoppiamento vaso-

Caratteristiche Tecniche		
Altezza di installazione	cm	38 - 68
Diametro del tubo di scarico	mm	50
livello di sopravanzo	cm	22 - 42
Sistema di azionamento		pneumatico
Velocità di deflusso	1/3	2,0

Materiali Impiegati	
●	Ottone laminato OT 67 UNI 5705/65 per rosette
●	Ottone anfibio OT 63 UNI 5705/65 per tubi
●	Ottone trohlato OT 58 UNI 5705/65 per particolari torniti
●	Ottone esimo OT 58 IN 5705/65 per podicolari stampati a caldo
●	Acciaio inox AISI 304
●	Poro naturale additivato al silicone per le guarnizioni di chiusura
●	Pulsante del comando pneumatico dotato di guarnizione o labbro in NBR•75

**73102 BATTERIA UNIBOX ATT.LATERA** ITS Art. 5.00L/M P/C.1



**UNMOX entrata bassa**

- Pulsante di comando pneumatico.
- Gruppo di scarico centrale.
- Rubinetto a galleggiante attacco basso.
- Comprese guarnizioni e viti per accoppiamento vaso-cassetta.

Caratteristiche Tecniche		
Altezza di installazione	cm	38 - 68
Diametro del tuba di scarico		50
livello di sopravanzo	CT	22 - 42
Sistema di azionamento		pneumatico
Velocità di deflusso	1/5	2,0

Materiali Impiegati	
●	Ottone laminato OT 67 IN 5705/65 per rosette
●	Ottone trofilata OT 63 UNI 5705/65 per tubi
●	Ottone trafilato OT 58 UNI 5705/65 per particolari torniti
●	Ottone estruso OT 58 UNI 5705/65 per paticalari stampati a caldo
●	Acciaio iosa AISI 304
●	Para naturale additivato al sITicone per le guarnizioni di &usura
●	Pulsante del comando pneumatico dorato di guarnizione o labbro in NFR75

**73103 BATTERIA UNIBOX BASSO** ITS Art. 5.00T/M P/C.1

**Ricambi Per Batterie Pneumatiche Todini**



*FLUIDMASTER attacco alto galleggiante universale made in USA.*

**73116 RUB.GALLEGG FLUID LATERALE** ITS Art. 3.01 P/C.1



*FLUIDMASTER attacco basso galleggiante universale made in USA.*

**73117 RUB.GALLEGG.FLUID BASSO/TE** ITS Art. 3.01/T P/C.1

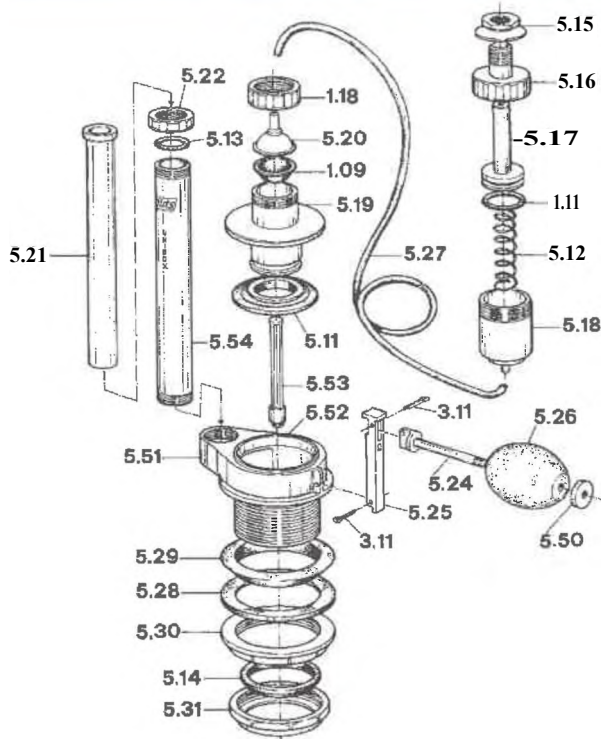

*Ricambi batteria  
PNEUMATICA UNIBOX*

- 1.09 Cappello di sollevamento
- 1.11 O-RING di tenuta del pulsante
- 1.18 Ghiera di serraggio del cappello
- 3.11 Coppiglia Inox
- 5.11 Membrana di chiusura
- 5.12 Molla inox per pulsante di comando
- 5.13 O-RING di tenuta del sopravanzo telescopico
- 5.14 Guarnizione premistoppa 0 50
- 5.15 Borchia del pulsante di comando
- 5.16 Coperchio del cilindro di comando
- 5.17 Pulsante di comando
- 5.18 Cilindro di comando
- 5.19 Campana
- 5.20 Cupoletta di presa aria
- 5.21 Tubo sopravanzo telescopico
- 5.22 Ghiera di serraggio del telescopio
- 5.24 Perno di bloccaggio
- 5.25 Leva di bloccaggio
- 5.26 Galleggiante di polistirolo
- 5.27 Tubo flex PVC
- 5.28 Guarnizione piana 2"
- 5.29 Guarnizione conica 2"
- 5.30 Ghiera di serraggio alla cassetta
- 5.31 Ghiera di serraggio del tubo 0 50
- 5.50 Contropeso
- 5.51 Base
- 5.52 Anello inox
- 5.53 Perno di sollevamento
- 5.54 Tubo inferiore del sopravanzo
- 5.80 Campana completa (art 1.18+5.20+1.09+5.19+5.11)

<b>73165</b>	<i>MOLLA INOX PULSANTE UNIBOX</i>	ITS M. 5.12	P/C.1
<b>73168</b>	<i>CAMPANA x UNIBOX</i>	ITS Art. 5.19	P/C.1
<b>73163</b>	<i>MEMBRANA C'HIUSURA x UNIBOX</i>	ITS Art. 5.11	P/C.1
<b>73155</b>	<i>CAPPELLOTTA SOLLEVAMUNIBOX</i>	ITS Art. 1.09	P/C.1
<b>73157</b>	<i>O-RING x PULSANTE COMANDO</i>	ITS Art. 1.11	P/C.1
<b>73159</b>	<i>SERR. CAPPELLOTTA</i>	ITS Art. 1.18	P/C.1
<b>73170</b>	<i>CUPOLETTA PRESA ARIA</i>	ITS Art. 5.20	P/C.1
<b>73172</b>	<i>LEVA DI BLOCCAGGIO</i>	ITS Art. 5.25	P/C.1
<b>73174</b>	<i>GALLEGGIANTE POLISTIROLO</i>	ITS Art. 5.26	P/C.1
<b>73176</b>	<i>GHIERA .SERRAGLIO CASSETTA</i>	ITS Art. 5.30	P/C.1



**Adatto per tutte  
le batterie pneumatiche**

<b>73177</b>	<i>GRUPPO DI COMANDO</i>	ITS Art. 5.91	P/C.1
--------------	--------------------------	---------------	-------



<b>73160</b>	<i>RUBINETTO ARRESTO A SQUADR</i>	ITS Art. 5.09	P/C.1
--------------	-----------------------------------	---------------	-------



<b>73161</b>	<i>TAPPO COPRIFORO ABS CROMAT</i>	ITS Art. 5.10	P/C.1
--------------	-----------------------------------	---------------	-------

*Per collegare galleggianti in cassetta  
con attacco basso tipo Ideal Standard.*

<b>73108</b>	<i>RACCORDO ATTACCO BASSO</i>	ITS Art. 5.05	P/C.1
--------------	-------------------------------	---------------	-------



**Completo per cassetta  
monoblocco**

Accessorio per l'accoppiamento  
vaso-cassetta completo di:

- Guarnizione di supporto tipo standard
- 0115mm.
- Coppia di tiranti in ottone.

<b>73111</b>	<i>COMPLETO x CASS MONOBLOCCO</i>	ITS Art. 5.01	P/C.1
--------------	-----------------------------------	---------------	-------



**Completo per cassetta sifonic (vaso ad aspirazione)**



- Tubo di collegamento cassetta-vaso 0 50 - 50, L-190 mm., in ottone cromato.
- Rosone sotto cassetta in ottone cromato.
- Morsetto vaso tipo siFonic.

73112 COMPLETO x CASS SIFONIC ITS Art. 5.04 P/C.1

MOblig  
 rathgrafhc  
 Pienale avari  
 Rubinetto o pulsante in ottone cromato con getta tegolebde  
 Accumulo d acqua teft.geroto It  
 Setboiano vcomknotote "Di cubetucor,  
 Gruppo tugonlero ermetico uenziuse des w 130/v 220  
 Polon tr - nrco d. protezione , mino - utente outornotico termostato Pi egokmone  
 Unzeon. lino,  
 MAGIA' iv mod X 1 noolloto lmito  
 POSO nero kg 25 800  
 PER F iteSEPittatiONC OCCORRE presa d'acqua 3/8 stanco 0 30 mm peso dein«. 224.

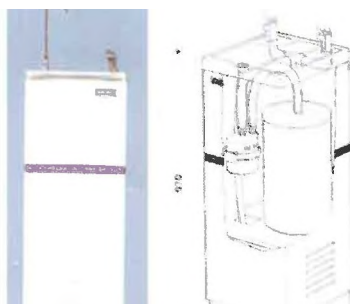

73184 REFRIGERATORE FRESHBOX ITS Art. 11.00/P

**Per la purificazione dell'acqua grazie a filtrazione meccanica. Con MICROPEDE per alimenti. Acqua filtrata a 0,1 micron.**

X-1	
Csiteccio	RS-1SG
Mirante	0,1 micron
Por olo	4 limin
Capacità (*)	4.0001.
POSO	1,4 Kg
Dimensioni	012,2 x H 13,7 an

73181 CARTUCCIA RS-1SG x FRESHB ITS Art. 10.13 P/C.1

**Doccetta C/Pulsante**



**Filetto adatto al flessibile art 74635**

74848 DOCCETTA C/PULSANTE BIANCA REAV Art. 01706 BIANC P/C.1

**Flessibile Per Doccetta**



**Flessibili per doccia in ottone cromato per monoforo**



74635 FLESSIBILE x MONOF 3/8x150 COT Ad. 110 020 150 P/C.1

**Flessibile Per Doccia In Ottone Cromato**



**Cromato e aggraffato**

74629 FLESSIBILE x DOCCIA 100 cm COT Art. 110 010 100 P/C.1

74630 FLESSIBILE x DOCCIA 120 cm COT Art. 110 010 120 P/C.1

74631 FLESSIBILE x DOCCIA 150 cm COT Art. 110 010 150 P/C.1

74632 FLESSIBILE x DOCCIA 200 cm COT Art. 110 010 200 P/C.1

**Flessibile Per Doccia Con Doppia Aggraffatura In Ottone Cromato**



**Thbo flessibile in ottone cromato. Doppia aggrattatimi. Attacchi 1/2 FE Completo di guarnizioni. Confezionato singolarmente. Lungh.: 120 cm Lungh.: 150 cm Lungh.: 200 cm QUALITA' SUPER**

74561 FLEXDOC OT/CR D. GRAF 120 C FX Art. 16210C120CR P/C.1

74562 FLEX DOC OT/CR D. GRAF 150 CFX Art. 16210C150CR P/C.1

74563 FLEX DOC OT/CR D. GRAF 200 C FX Art. 16210C200CR P/C.1

**Flessibile Per Doccia Con Gomma**



**Tubo flessibile in PVC nero/cromo. Attacchi: 1/2 FE. Completo di guarnizioni. Confezionato singolarmente. Lungh.: 120 cm Lungh.: 150 cm Lungh.: 200 cm**

74503 FLESSIBILE 120 PLAST.CROMO EMU Art. 301 P/C.1

74505 FLESSIBILE 150 PLAST.CROMO EMU Art. 301 P/C.1

74507 FLESSIBILE 200 PLAST. CROMO EMU Art. 301 P/C.1

**Flessibile Per Doccia Con Doppia Aggraffatura  
In Ottone Cromato Gommato Grohe**

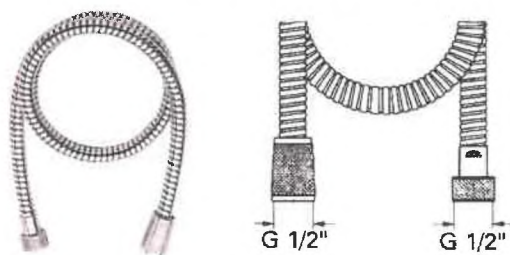

- 74737 FLESSIBILE 125 cm** GROArt. 28150 P/C.1  
**74741 FLESSIBILE 150 cm** GROArt. 28151 P/C.1  
**74743 FLESSIBILE 200 cm** GROArt. 28155 P/C.1

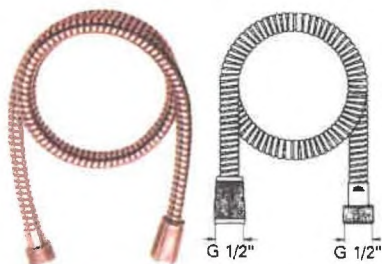

**Flessibile RELEXAFLEX**  
 1/2" x 1/2", lungo 1250mm,  
 1/2" x 1/2", lungo 1500mm  
 1/2" x 1/2", lungo 2000mm.

- 70718 FLESS.DOCCIA 150 CM CR/ORO** GROArt. 28151 -IG P/C.1

**Flessibile Per Doccia Con  
Gommatura Esterna Colorate**



Tubo di plastica stretch-flex con raccordo  
conico 1/2"x1/2" FF.

- 74469 FLESSIBILE 150 CONICO OTTO** CFX Art. 16295C1500r P/C.1  
**74513 FLESSIBILE 150 CONICO BIAN** CFX Art. 16295C150CL P/C.1  
**74514 FLESSIBILE 200 CONICO BIAN** CFX Art. 16295C200CL P/C.1

**Supporti Per Doccette Con  
Sede Conica A Muro**



**SUPPORTO DOCCIA FISSO**  
 Realizzato in ABS.  
 Colore **cromato**.

- 74540 SUPPORTO A BAIONET CON CR** FRS Art. 8120 P/C.20



**SUPPORTO ORIENTABILE**  
 Realizzato in ABS.  
 Con ghiera in ottone.  
 Colore **cromato**.

- 74535 SUPPORTO GIREVOLE CROMATO** FRS Art. R132 P/C.1



**Supporto TOP**

**Supporto fisso da  
scegliere come atteincitiva  
al safiscent  
CROMATO**

- 74365 SUPPORTO REGOLAB TOP CRO** VSN Art. SUP51CR P/C.1

**Supporto murale fisso**

per manopola doccia o per  
portasapone

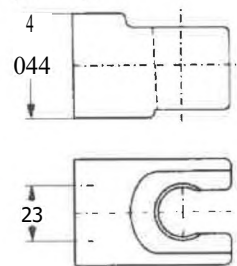

- 74752 SOSTEGNO DOCCIA MURO FISSO** GROArt. 28622 CR P/C.1

**Supporto murale regolabile**

per manopola doccia.

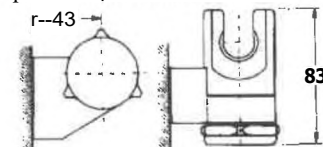

- 74753 SOST. DOCCIA MURO REGOL** GROArt. 28623 CR P/C.1



**SUPPORTO PER DOCCIA  
In ABS. Con attacco conico.**  
 Colore: **cromato**  
**Confezioni da 5 pezzi.**

- 74475 SUPPORTO SNODO ATT/CON CRO las** Art. 63500/STA P/C.1

- 74476 SUPPORTO SNODO ATT/CON BIA IAS** Art. 63502/STA PIC.1

- 74477 SUPPORTO SNODO ATT/CON DORIA s** Art. 2184 P/C.1

**Prese Acqua Per Plesbill  
Sallsoendl Docola**



**GOMITO IN OTTONE  
CROMATO MM**

**Misura Pz. per Conf.**  
 1/2 50

- 58075 275 GOMITO CROMATO MM 1/2** EDR Art. 1.474 P/C.10

er(

G1/2"  
067

**Raccordo erogatore**  
a muro da 1/2", con parte  
frontale satinata,  
o cromata lucida.

9-19  
G1/2"

- 74756 RACCORDO EROG. DOCCIA LUC. GRO Art. 28636 P/C.1
- 74755 RACCORDO EROG. DOCCIA SAT. GRO Art. 28626 P/C.1
- 74774 RACCORDO EROGATORE BIANCO GRO Art. 28626L P/C.1

**Raccordo erogatore**  
a muro da 1/2", con supporto  
per manopola doccia.

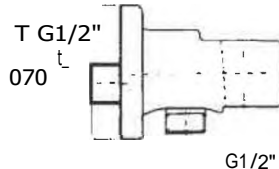

9-19

- 74757 RACCORDO EROG. DOCCIA CROM GRO Art. 28628 P/C.1



**PRESE D'ACQUA**  
101ROSANITACA  
Tonda.  
Cromata.  
Attacco Maschio 1/2 x 1/2  
**Colore: cromato**  
Confezioni da 5 pezzi.

- 74487 PRESA ACQUA MM A TONDA CRO las Art. 66300/STA P/C.1

**Accessori Per Bracci Doccia  
Soffioni E Saliscendi**

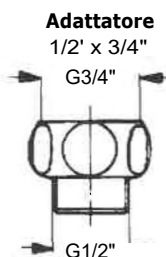

- 74760 ADATTATORE 1/2x3/4 CROMATO GRO Art. 28817 P/C.1



**Solo supporto**

- 74677 SUPPORTO REGOLAB x EURO 90 cor P/C 10

*Saliscendi Grohe*



**Relaxa plus**  
Set asta doccia lunga 600 mm.  
completo di:  
supporto scorrevole.  
manopola **anticalcare** a due getti,  
portasapone scorrevole  
e flessibile da 1500 mm  
Cromo.

- 74762 ASTA DOCCIA CROM C/P 600MM GRO Art. 28669 P/C.

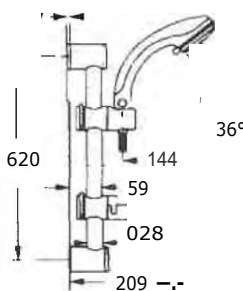

**Set asta doccia lunga 600mm.**  
con supporto scorrevole,  
completo di:  
asta doccia  
manopola **anticalcare**  
**REGOLABILE** a due getti  
stretto forte e largo normale  
portasapone scorrevole  
e flessibile

- 74764 ASTA DOCCIA 2/GETT P/SA CR GRO Art. 28643 P/C.1

**GROHE**

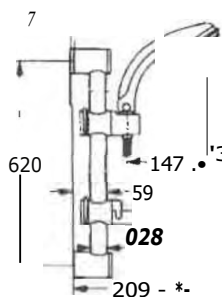

**Set asta doccia lunga 600mm.**  
 con supporto scorrevole,  
 completo di:  
 > asta doccia  
 manopola **anticalcare**  
**MASSAGGIO SOFT** a due getti  
 normale e "massaggio soft"  
 portasapone scorrevole  
 e flessibile

**74766 ASTA DOCCIA C/DOC SOFT CR** GRO Art. 28646 P/C. 1

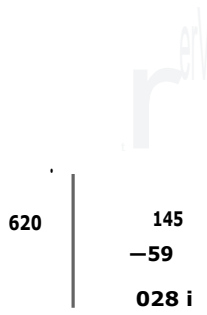

**Set asta doccia lunga 600mm**  
 con supporto scorrevole,  
 completo di:  
 16° asta doccia  
 36° manopola anticalcare  
**IDROMASSAGGIO** a due getti  
 normale e "idromassaggio"  
 portasapone scorrevole  
 e flessibile

**74765 ASTA DOCCIA C/DOC COMPL CR** GRO Art. 28648 P/C. 1

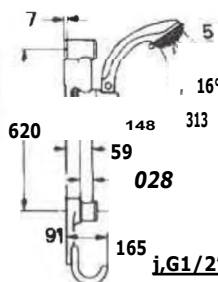

**Set asta doccia lunga 600mm.**  
 con supporto scorrevole,  
 completo di:  
 asta doccia  
 manopola **anticalcare** TOP 4 a  
 quattro getti: largo normale,  
 stretto forte, massaggio soft e  
 idromassaggio  
 portasapone fisso  
 e flessibile

**74768 ASTA DOCCIA TOP 4 CROMATA** GRO Art. 28650 P/C. 1

**Distanziatore trasparente**  
 da 7,5mm. per aste doccia

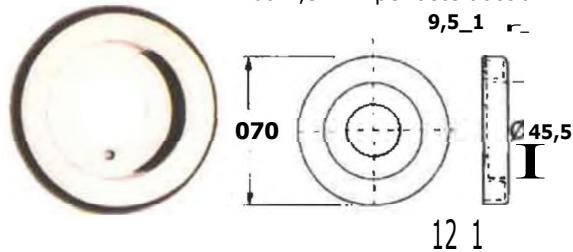

**74719 DISTANZIATORE x ASTA** GRO Art. 45459 P/C. 1

**Accessori Saliscendi Grohe**

**028 Portasapone scorrevole**  
 per aste doccia  
 (per tutti i nuovi modelli)

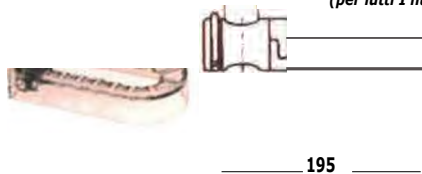

**74770 PORTASAPONE SCORREVOLE §28** GRO Art. 28631 P/C. 1

**025 Portasapone scorrevole**  
 per asta doccia  
 oppure per set asta doccia  
 (per vecchi modelli o 25 mm  
**Friedrich Grohe**)

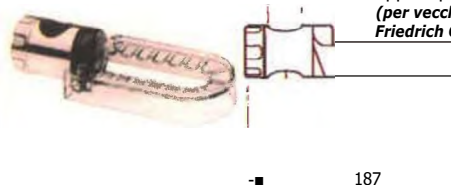

**74777 PORTASAPONE PER SALISC. CR** GRO Art. 28856 P/C. 1





**Portadoccino o 29 mm**  
**Adatto per il montaggio**  
**su tutte le aste doccia**  
**OROHE di nuova produzione**

**74796** SUPPORTO SCORREV x 28620 GROArt. 45650 IP P/C.1



**SUPPORTO. SCORREVOLE**  
**per saliscendi o 25 mm**  
**(vecchi modelli Friedrich Grohe)**

**74797** SUPPORTO SCORREVOLE GROArt. 07659 P/C.1

**Saliscendi**



**Saliscendi MONOCLEAN**  
**Con portasapone.**  
**Lung. asta: 65 cm**  
**o asta: 24 mm**  
**Flessibile: 145 cm**  
**Doccia con sistema**  
**rapido ANTICALCARE.**  
**getto: Normale**  
**Colore: cromato**

**73539** SALISCEN P.SAP MONOCLEA CR SOL Art. 62546.C P/C.10



**Saliscendi DUOCLEAN**  
**Con portasapone.**  
**Lung. asta: 65 cm**  
**o asta: 24 mm**  
**Flessibile: 145 cm**  
**Doccia con sistema**  
**rapido ANTICALCARE.**  
**3 getti: Normale**  
**Soft**  
**Massaggio**  
**Colore: cromato**

**73538** SALISCEN P.SAP DUOCLEAN CR SOL Art. 62545.C P/C.10



**Saliscendi ONDAPLUS**  
**Lung. asta: 65 cm**  
**o asta: 24 mm**  
**Flessibile: 145 cm**  
**3 getti: Normale**  
**Soft**  
**Massaggio**  
**Colore: cromato'**

**73587** SALISCENDI P.SAP ONDAPL CR SOL Art. 58519-C P/C.10

**73588** SALISCENDI P.SAP ONDAPL BI SOL Art. 58519-NE

**73592** SALISCEN ONDAPL C/PS CR/OR SOL Art. 58519-DC P/C.10



**Saliscendi NORDIN**  
**Con portasapone.**  
**Lung. asta: 60 cm**  
**o asta: 24 mm**  
**Flessibile: 145 cm**  
**Doccia con sistema**  
**rapido ANTICALCARE.**  
**3 getti: Normale**  
**Soft**  
**Massaggio**  
**Colore: cromato**

**73586** SALISCENDI P.SAP NORDIN CR soL Art. 62542.c P/C.10

**Accessori Per Saliscendi**



**ASTA PER DOCCIA**  
**Lung. asta: 65 cm**  
**o asta: 24 mm**

**73540** ASTA SALISCENDI C/SUPP CR SOL Art. 58514.C P/C.10

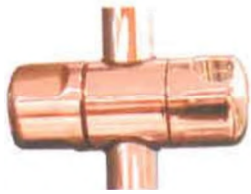

**SUPPORTO SCORREVOLE  
per saliscendi**

**73599 CENTRALINA SCORR x SALISC** SOL Art. 67316-C P/C.10



*Per bordo vasca*

- Centrale in ottone 80 mm o 3/4
- Innesto per flex con calotta conica

**74371 PORTA FLES/DOC/B/VASCA CRO** VSN Art. CENO3CR P/C.1



**Ag :SALISCENDI  
IDROSANITARIA MAGIC**

**Colore bianco..**  
**Getto:** pioggia - massaggio - areato  
**Altezza:** 80 cm  
**Con portasapone**



**74445 SALISCENDI C/PORTASAP BIA** IAS Art. 6582+3209 P/C.1

**Doccette Grohe**



Flelexa plus  
▶ Manopola doccia

- sistema anticalcare "Speed Clean"
- sistema integrato "Grohclick"

**74769 DOCC 2G STRETTO E LARGO** GRO Art. 28172 P/C.1

**GROHE**



**Manopola doccia**

**"MASSAGGIO SOFT"** a due getti normale e "massaggio soft" con sistema anticalcare "Speed Clean" e sistema integrato Grohclick per un facile cambio e per impedire l'attorcigliamento del flessibile. Adatta anche per scaldabagni istantanei.

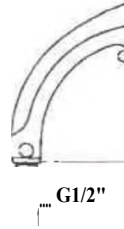

147

**74721 DOCC 2G NORMALE/MASSAGGIO** GRO Art. 28174 P/C.1

**70719 DOCC 2G NORMALE/MASS CR/OR** GRO Art. 28174-160 P/C.1



**Manopola doccia**

**"IDROMASSAGGIO"** a due getti normale e "idromassaggio" con sistema anticalcare "Speed Clean" e sistema integrato Grohclick per un facile cambio e per impedire l'attorcigliamento del flessibile. Adatta anche per scaldabagni istantanei.

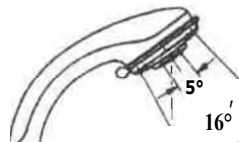

G1/2"

L--145

**74722 DOCC 2G NORMALE/IDROMAS** GRO Art. 28176 P/C.1



**Manopola doccia**

**"TOP 4"** a quattro getti: largo normale, stretto forte, "massaggio soft" e "idromassaggio" con sistema anticalcare "Speed Clean" e sistema integrato Grohclick per un facile cambio e per impedire l'attorcigliamento del flessibile. Adatta anche per scaldabagni istantanei.

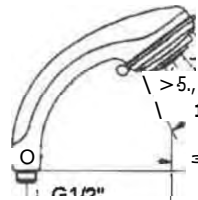

**74763 DOCC 4G TOP 4 CROM**

GRO Art. 28178 P/C.1





**SUPPORTO MURALE  
per DUPLEX**

74622 SUPPORTO NORM. DUP TRI MUR COT Art. 130 030 000 P/C.1



**GANCIO MURALE  
IN OTTONE  
Finiture cromate.**

- Supporto a muro in ottone per Doccia Jet

74368 GANCIO MURALE FIS077' CRO VSN Art. ACC08CR P/C.1



74810 GANCIO MURO x DOCC OTT/CRO NIAV Art. 2208 P/C. 1



**CURVA PER DUPLEX**

74627 CURVA FISSA x DUPLEX COT Art. 160 010 000 P/C.1



74367 SUPPORTO FIS C/GANCIO CRO VSN Art. GAN02CR P/C.1

**Doccette**



**DOCCIA VENERE PER DUPLEX**  
Doccia monogetto in ABS.  
Manopola bianca in ABS.  
Attacco: 1/2 M.  
Finiture cromate.  
Completa di guarnizione.

74626 DOCCIA VENERE x DUPLEX B COT Art. 150 050 000 P/C.12



**DOCCIA PESANTE PER DUPLEX**  
Doccia monogetto in ottone.  
Manopola bianca in ABS.  
Attacco: 1/2 M. Finiture cromate.  
Completa di guarnizione.

74628 DOCCIA PESANTE x DUPLEX B COT Art. 150 080 000 P/C.10

ra

'41914«

**FLAVIA CON CURVA DUPLEX**  
Doccia monogetto in ottone.  
Manopola bianca in ABS.  
Attacco: 1/2 M.  
Finiture cromate.  
Completa di guarnizione.

74321 DOCCET FLAVIA C/CURVA CRO VSN M. DFLO7CR P/C.1



Doccetta completa di duplex lusso cromato con flessibile di cm.150. Colore nero.

74619 DOCCCL4DUPLEX LUSO NORM. COT M 120 020 150 PIC.1



**ARDEA CON CURVA**  
Doccia monogetto in ottone.  
Manopola bianca in ABS.  
Attacco: 1/2 M.  
Finiture cromate.  
Completa di guarnizione.

74324 DOCCETTA ARDEA C/CURVA CRO VSN Art. DAR01CR P/C.1



- Doccia Beta monogetto attacco da 1/2 M

74316 DOCCETTA BETA CRO VSN Art. DBE01CR P/C.1



**ARDEA**  
Doccia monogetto in ottone.  
Manopola bianca in ABS.  
Attacco: 1/2 M.  
Finiture cromate.  
Completa di guarnizione.

74323 DOCCET7A ARDEA CRO ~Art. DAR03CR P/C.1

# mez

**FLAVIA**  
Doccia monogetto in ottone.  
Manopola bianca in ABS.  
Attacco: 1/2 M.  
Finiture cromate.  
Completa di guarnizione

**74320 DOCCETTA FLAVIA MAN/B CRO** VSN Art. DFLIXICR P/C.1

# 43

**DOCCIA NORMALE BIANCA**  
Doccia monogetto in ottone.  
Manopola bianca in ABS.  
Attacco: 1/2 M.  
Finiture cromate.  
Completa di guarnizione.

**74672 DOCCIA NORMALE BIANCA** COT M. 150 110 000 P/C.10

# 91. 1114

**DOCCIA PESANTE**  
Doccia monogetto in ottone.  
Manopola bianca in ABS.  
Attacco: 1/2 M.  
Finiture cromate.  
Completa di guarnizione.

**74670 DOCCETTA PESANTE BIANCA DR** curar/. 150 070 000 P/C.10



**JET**  
Doccia estraibile  
per lavelli monogetto con anello.  
Attacco: 1/2 M.  
Colore nero.  
Completa di guarnizione.

**74329 DOCCETTA JET C/ANELLO NER** VSN Art. DJEO1 NE P/C.1



**BETA Soft Clean**  
Doccia monogetto  
anticalcare.  
Attacco: 1/2 M.  
Finiture cromate.

**74317 DOCCETTA BETA SOFT CLEAN CRO** VSN Art. DBE2OCR P/C.1

# 4t,

**70194 DOCCETTA TELE!?** C/ANEL CROM INAV Art.01756BI P/C. 1



**EIP**  
**Doccia LIMPIDA**  
Con anticalcare  
"Quick Clean"  
Getto: pioggia  
**CROMATA BIANCA**

**74431 DOCCIA LIMPIDA CROMATA** IAS Art. 12100/LUX P/C.1

**74432 DOCCIA LIMPIDA BIANCA** IAS Art. 12102/LUX P/C.1



**DOCCIA**  
**CURVA-JET**

3 getti: pioggia - massaggio - mix  
Colore: cromata o bianca

**74423 DOCCIA CURVA-JET C/IDR BIA** IAS Art. 19002/LUX P/C.1



**Doccia CURVA-JET**  
3 getti: pioggia - massaggio - mix  
**CROMATA BIANCA**

**74422 DOCCIA CURVA-JET C/IDR CRO** IAS Art. 19000/LUX P/C.1

# 49-11110

**Doccetta DUOCLEAN**  
2 getti: pioggia - massaggio  
Con snodo antiarrotolemento.  
Colore cromato

**73579 DOCC'ETTA DUOCLEAN 2 GETTI** sot. An. 62417 RIC 1



**Doccia CASCADE**  
3 getti: pioggia -  
massaggio - mix  
**BIANCA**

**74430 DOCCIA CASCADE C/IDR BIA** IAS m 1 7002/LUX P/C.1



**Doccetta ONDAPLUS**  
3 getti: pioggia - massaggio - mix  
Con snodo antiarrotolemento.  
Colore cromato

**73580 DOCCETTA ONDAPLUS 3 GET CR** SOL Art. 58003-C P/C.1



**Doccetta NETTUNO**  
3 getti: pioggia - massaggio - areato  
Con anticalcare Easy Clean.  
Colore cromato

73705 **DOCCETTA NETTUNO CROM** CIS Art. DS01408021 P/C.1



**Doccia STAR**  
Con anticalcare "Quick Clean"  
3 getti: pioggia - massaggio - mix  
**CROMATA**

74433 **DOCCIA STAR MASS ACQUAP CR** IAS Art. 11000/STA P/C.1



**Doccetta NORDIN**  
3 getti: pioggia -  
massaggio - mix  
Con anticalcare.  
Colore cromato

73536 **DOCCETTA NORDIN 3 GETTI CR** soL Art. 62420-C P/C.1



**Doccetta SIRIO**  
3 getti: pioggia - massaggio - aree()  
Con anticalcare Easy Clean.  
Colore cromato /satinato.

73704 **DOCCETTA SIRIO CROMO/SAT** CIS Art. DS01407078 P/C.1

**Accessori Per Doccette**



**GUARNIZIONE  
PRE-DOCCETTA**  
con filtro INOX.  
Misura: 1/2".  
Confezioni da 50  
pezzi.

74376 **GUARN.CON FILTRO INOX 1/2** L-G Art. FI 012 P/C.1

74377 **GUARN.CON FILTRO INOX 3/4** L-G Art. FI 034 P/C.

**RIDUTTORE AUTOMATICO  
DI PORTATA PER DOCCIA  
A TARATURA FISSA**  
Permette di ridurre il consumo  
d'acqua grazie all'erogazione  
controllata di 7 lemin.  
indipendentemente dalla  
pressione del dispositivo  
di uscita. (da 0,5 a 9 bar)



71620 **RIDUTT AUT. DI PORI: 7L I/2** RVR Art. R00280/7 P/C.

**Braccio Doccia Senza Soffione**



74612 **BRACCIO NORM CROM 20 cm** COT Art. 170 010 020 P/C.1

74613 **BRACCIO NORM CROM 30 cm** COT Art. 170 010 030 P/C.1

74614 **BRACCIO NORM CROM 40 cm** COT Art. 170 010 040 P/C.1

**NIPPLES PER  
BRACCIO DOCCIA  
In ABS.**  
Attacco Maschio  
1 1/2" x 1 1/2"  
Colore: cromato



74490 **NIPPLES x BR/DOC 1/2 MM** IAS Art. 57910/srA P/C.1



11=54

74609 **BRACCIO DOCCIA PES. 1/2 M** COT Art. 170 120 020 P/C.1



74656 **BRACCIO FUSO C/GOWINO** COT Art. 170 040 020 P/C.1



**BRACCIO DOCCIA TONDO**  
In ottone.  
Colore: cromato  
Confezioni da 5 pezzi.

74441 **BRACCIO DOCCIA TONDO OT/CR** has Art. 54500/LUX P/C.1

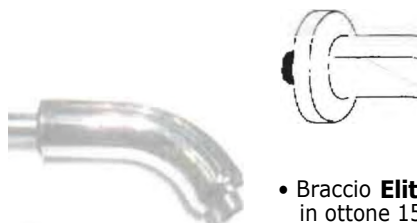

• Braccio **Elite Plus**  
in ottone 15 cm  
Rosone 0 55 mm  
Attacco 1/2 MM

74335 **BRACCIO DOCELITE PLUS CRO** VSN Art. BRA10CR P/C.1

## Soffioni Da Doccia

14

**SPIAGGIA**  
Soffione fisso  
INOX.  
Attacco: 1/2 F.  
Finiture cromate.  
Completo di guarnizione.

**74351 SOFFIONE SPIAGGIA CRO**

VSN Art. SOF13CR P/C.1



**CAMPANA**  
Soffione snodato  
in ottone.  
Attacco: 1/2 E  
Finiture cromate.  
Completo di guarnizione.

**74825 SOFFIONE DOCCIA A CAMPANA** MAV Art. 01955 P/C.1



**ECONOMY**  
Soffione snodato  
in ottone.  
Attacco: 1/2 E  
Finiture cromate.  
Completo di guarnizione.

**74349 SOFFIONE ECONOMY CRO** VSN Art. SOF07CR P/C.1



**74750 SOFFIONE DOCCIA** 1/2 CRO Art. 29400 P/C.1



**STELVIO**  
Soffione snodato in ottone.  
Attacco: 1/2 E  
Finiture cromate.  
Completo di guarnizione.

**74639 SOFFIONE DOCCIA STELVIO** COT Art. 180 050 000 P/C.1



**40r**

**APOLLO**  
Soffione snodato in ottone.  
Attacco: 1/2 E  
Finiture cromate.  
Completo di guarnizione.

**74346 SOFFIONE APOLLO** CRO VSN Art. SOF06CR P/C.1



**do.**

**ANTI-SCALE**  
Soffione snodato  
in ottone  
con dispositivo  
automatico anti-  
calcicare.  
Attacco: 1/2 E  
Finiture cromate.  
Completo di guarnizione.

**74354 SOFFIONE ANTI-SCALE CRO** VSN Art. SOF10CR P/C.1

**GAVER**  
Soffione snodato  
in ottone  
con dispositivo  
automatico anti-  
calcicare.  
Attacco: 1/2 E  
Finiture cromate.  
Completo di guarnizione.

**74601 SOFFIONE ANTICALCARE GAVER** COT Art. 180 030 000 P/C.1

**.42  
tt**

**do**

**Soffione TEAM-JET**  
**Con anticalcare**  
**"Quick Clean".**  
**Snodato.**  
**Getto: pioggia**  
**Colore: cromato**  
**Confezioni da 5**  
**pezzi.**

**74452 SOFFIONE DOC TEAM-JET CR** IAS Art. 59020/LUX P/C.1



• Soffione snodato **Softy Jet**  
a getto regolabile, in ottone  
Attacco 1/2" F

**74357 SOFFIONE SOFTY JET CRO** VSN Art. SOF12CR P/C.1



**Soffione HIMALAYA**  
**Snodato.**  
**2 getti: pioggia**  
**mix**  
**Colore: cromato**  
**Confezioni da 5 pezzi.**

**74456 SOFFIONE HIMALAYA 2GETT CR** las Art. 59580/LUX P/C.1



### Soffione TIPO Plus

Soffione con regolazione di getto isentini anticalcare  
Corfuccio cromato che ritarda la :oli i èclzione dei coloni :  
speciale filtro di siurezza<3  
ghiera per io selezione aei getti.  
**CROMATO**

74344 SOFFIONE TIPO PLUS CRO VSN Art. SOF30CR P/C.1



### Soffione MULTI-JET Snodato.

3 getti: pioggia  
massaggio  
mix

Colore: cromato  
Confezioni da 5 pezzi.

74455 SOFFIONE MULTI-JET MASS CR IAS Art. 59350/LUX P/C.1



### SOFFIONE DOCCIA TURBO-JET

Snodato.  
Getto: pioggia - massaggio - creato  
Colore: cromato  
Confezioni da 5 pezzi.

74453 SOFFIONE TURBO-JET MASS CR IAS" M. 59150/LUX



### Soffione TEAM-JET Con anticalcare "Quick Clean". Snodato.

3 getti: pioggia  
massaggio  
mix

Colore: cromato  
Confezioni da 5 pezzi.

74458 SOFFIONE PLURI-JET MASS CR IAS Art. 59300/LUX P/C.1



### Soffione POLO Plus

Soffione Doccia a tre getti:  
Nonno: ✓ Mossane.  
Cartuccia cromata c ne ritarda  
la tormazione dei calcrif,.,.  
speciale filtro di siurezza.  
ghiera per la selezione dei getti.  
**CROMATO**

74342 SOFFIONE POLO PLUS CRO VSN Art. SOF42CR P/C.1



G1/2"

### Soffione doccia laterale

a getto normale con  
sistema anticalcare  
- Speed Clean".

Completo di braccio e raccordo  
a sfera orientabile.



1. 160 052

74746 SOFFIONE LATERALE DOCCIA GROM. 28198 P/C.1



LATERALE  
Soffione fisso  
In ottone.  
Attacco: 1/2 M.  
Finiture cromate.

74602 SOFFIONE DOCCIA LATERALE COT Art. 180110 P/C.1

### Bracci Doccia C/Soffione Montato

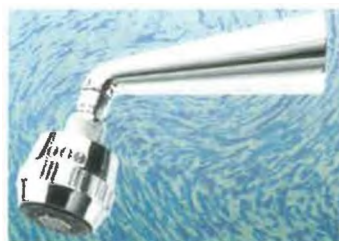

### BRACCIO DOCCIA TURBO-JET

IDROSANITARIA

Con soffione "Turbo-jet"  
Getto: pioggia - massaggio - creato  
Colore: cromato

74439 BRACCIO DOC C/SOF TURI? CRO IAS Art. 54600/LUX P/C.1



### Braccio Doccia CLIZIA

IDROSANITARIA

Con soffione e anticalcare  
Getto: pioggia  
Colore: cromato

74438 BRACCIO DOC C/SOF CLIZ CRO IAS Art. 55630/LUX P/C.1

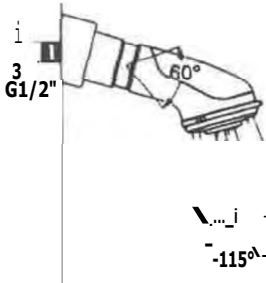

**Soffione doccia "IDROMASSAGGIO"** a due getti, normale e "idromassaggio" con sistema **anticalcare "Speed Clean"**. Completo di braccio e raccordo a sfera orientabile.

**74731 BRACCIO-SOFF-IDRO CROMATO** GROArt. 28194 P/C.1

**Accessori Bagno In Ceramica Da Incollare Export Bianca**

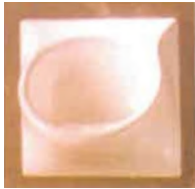

**mm.150x150**  
portasapone lavabo

**63600 PORTA SAPONE LAVABO BIAN** Art. 2001 R1 P/C.6



**mm. 150x75**  
portasapone bidet

**63602 PORTA SAPONE BIDET BIAN** C-L Art. 2003 R3 P/C.18

**mm. 150x150**  
portacarta con rullo in plastica

**63601 PORTA CARTA BIAN** C-L Art. 2002 R2 P/C.6



**mm.150x150**  
portabicchieri e spazzolini

**63603 PORTA BICCHIERE BIAN** C-1 Art. 2004 R4 P/C.6



**mm. 150x300**  
portasapone e spugna senza maniglia

**63604 PORTA SAPONE VASCA BIAN** CL Art. 2005 R5 P/C.4

**Accessori Bagno In Ceramica Da Incollare Export Champagne**

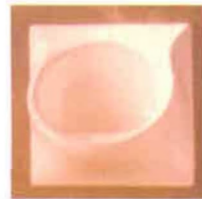

**mm.150x150**  
portasapone lavabo

**63606 PORTA SAPONE LAVABO CHAM** c-t. Art. 2001 R1 P/C.6



**mm. 150x150**  
portacarta con rullo in plastica

**63607 PORTA CARTA CHAM** C-L Art 2002 R2 P/C.6

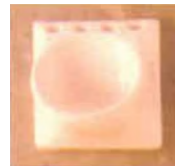

**mm.150x150**  
portabicchieri e spazzolini

**63609 PORTA BICCHIERE CHAM** C-L Art. 2004 R4 P/C.6

**Ar#Ini**

**mm. 150x300**  
portasapone e spugna senza maniglia

**63608 PORTA SAPONE BIDET CHAM** C-L Art 2003 R3 P/C.18

**Accessori Bagno In Ceramica Da Incollare Armonia Bianca**



portasapone lavabo

**63620 PORTA SAI' LAVAB INCOL BIAN** C-L Art. ARM1 P/C.6



portacarta

**63621 PORTA CARTA INCOL BIAN** C-1 Art. ARM2 P/C.6



portasapone bidet

**63622 PORTA SAI' BIDET INCOL BIAN** C-L Art. ARM3 P/C.18





cm. 30x11 cm. 56x11

**63708** PORTA SALVIETTE 60 cm BIAN **MPL** Ad. 110.286 P/C.1

**63709** PORTA SALVIETTE 30 cm BIAN **MPL** Art. 110.285 P/C.1



cm. 20x11

PORTAROTOLO/PORTASALVIETTA

**63710** PORTA ROTOLO APERTO BIAN **MPL** Art. 287 P/C.1



cm. 18x18

ANGOLARE DOCCIA

**63711** ANGOLARE BIAN **MPL** Art. 110.295 P/C.1



1  
0551

cm. 20x7

APPENDIABITO

**63712** APPENDIABITO TRIPLO BIAN **MPL** Art. 110.288 P/C.1



cm. L = 37

PORTASCIUGAMANI A SNODO

**63714** PORTA SALVIETTE SNODO BIAN **MPL** Art. 110.304 P/C.1

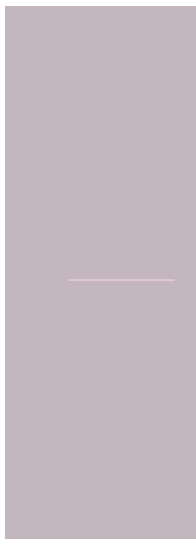

cm. Ø 27x h 160

PIANTANA PORTACCAPPATOIO

**63718** PIANTANA DANDY 2 ALTA BIAN **MPL** Art. 344 P/C.1



cm. Ø 30x39  
SGABELLO

**63716** SGABELLO TRIX BIAN **MPL** Art. 122 P/C.1

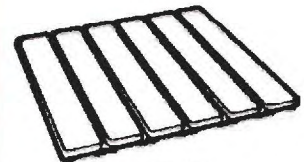

cm. 53x53  
BIANCA

**63724** PEDANA DOCCIA 53x53 BIAN **MPL** Art. 192 ZEBREPIC.1



cm. 31 x25x14

**63725** PORTA OGGETTI ANG. 2P BIAN **MPL** Art. 173 P/C.1



ALCUNE CONFIGURAZIONI

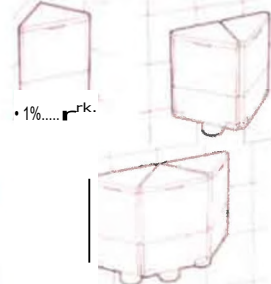

**63726** DISTRIB. SAPONE QUICK BIAN **MPL** Ad. 190 P/C.1

cm. 10x10x4  
PORTASAPONE

**63721** PORTA SAPONE CLIP APPOGGIO **MPL** Art. 334 B/CO P/C.1

METAFORM







**cm. 13x13x42**  
**PORTASCOPINO**

**63728 PORTA SCOPINO PENTA BLAN** MPL M. 156 P/C.1



**cm. h 74**  
**PIANTANA WC PORTAROTOLO/PORTASCOPINO**

**63730 PORTA SCORROT PENTA BLAN** MPL Art. 275 P/C.1



**cm. 13x13x12**  
**PORTAROTOLO**

**63731 PORTA ROTOLO PENTA BLAN** MPL M. 110.143 P/C.1



**cm. 15,5x10x9**  
**PORTABICCHIERE**

**63790 PORTA BICCHIERE EVY BLAN** MPL Art. 440 P/C.1



**cm. 15,5x10**  
**PORTASAPONE**

**63791 PORTA SAPONE EVY BLAN** MPL Art. 441 P/C.1



**cm. 47,5x11**  
**MENSOLA**

**63792 MENSOLA EVY BLAN** MPL Art. 442 P/C.1



**cm. 49x9**  
**PORTASCIUGAMANI**

**63793 PORTA SALVIETTE EVY BLAN** MPL Art. 445 P/C.1



**cm. 24x7x18**  
**PORTASCIUGAMANI AD ANELLO**

**63794 PORTA SALVANEL EVY BLAN** MPL Art. 453 P/C.1



**Qe)**

**cm. 8x6**  
**COPPIA APPENDIABITI**

**63795 COP APPENDIABITI EVY BLAN** MPL Art. 448 P/C.1



**cm. 13,5x12,5x8**  
**PORTAROTOLO**

**63796 PORTA ROTOLO EVY BLAN** MPL Art. 455 P/C.1



**cm. Ø 12x38**  
**PORTASCOPINO**

**63797 PORTA SCOPINO EVY BLAN** MPL Art. 456 P/C.1

**Accessori Bagno In Plastica  
Carrara E Matta**



**64558** *PORTA SCOPINO ANTILLE BIAN* C-M Art. 102481002 P/C.1



**64561** *PORTA SCOPINO ISEO BIAN* C-M Art. 101021002 P/C.1

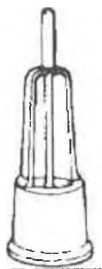

**64562** *PORTA SCOP. VERBANO BIANCO* C-M Art. 101024002 P/C.1



**64563** *PORTA SCOP. SPAZZOLO BIAN* C-M Art. 108225002 P/C.1



**64710** *PORTA SCOP. EGEO SET BIAN* C-M Art. 101032002 P/C.6



**64569** *SCOPINO ARNO BIAN* C-M Art. 108242002 P/C.1



**64552** *PORTA CARTA CHERSO BIAN* C-M Art. 101002002 P/C.1



**64711** *PORTA ROTOLO CRETA BIAN* C-M Art. 101007002 P/C.6



**64570** *SGABELLO CAPRI § 35 BIAN* C-M Art. 100942002 P/C.1



**64580** *MOBILE FARMACIA FREJUS BIA* C-M Art. 101413002 P/C.1

**64582** *MOBILE E VINCENT 65x48 BIA* CM Art. 104249002 PIC.1

Ir  
■ a

64583 MOBILE S.MORITZ 55x38 BIAN C-M Art. 104209002 P/C.1

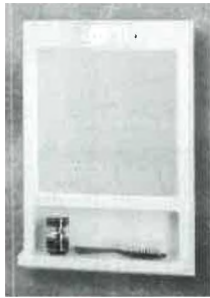

64585 SPECCHIERA GHANA C/LU BIAN cm Art. 102702002 P/C.1

**Porta Asciugamani Universali**  
(applicabili sui più diffusi modelli di termosifone)



67028 MOLLY PORTASCIUG 30/45 BIA DEA Art. 302

67029 MOLLY PORTASCIUG 50/90 BIA DEA Art. 602



111 111

67030 MOLLY PORTACCAPAT 40/55 BI DEA Art. 502

**Accessori Inda Per Il Bagno**



BELLO DEI BAGNO  
tonda



**Gancio per  
Plastica**  
**Bianco**

65006 GANCIO TENDA PLAST. BIANCO IND Art. 150 P/C.1

**Thbo per tenda doccia**

Estensibile.

\_\_\_\_\_ 4 L H P  
cm 60-90

\_\_\_\_\_ 4 L H P  
cm 85-135

\_\_\_\_\_ 4 L H P  
cm 130-220

**IMBALLO:** Scatola singola,  
completa di viti  
e tasselli.

65007 TUBO DOCCIA 60/90 CROM IND Art. A0146W P/C.1

65008 TUBO DOCCIA 85/135 CROM IND Art. A0146BAP P/C.1

65009 TUBO DOCCIA 130/220 CROM IND Art. A0146CAP P/C.1



Ad angolo.

L H P  
cm 80 80

Ad angolo.

L H P  
cm 170 70

Cromato

**IMBALLO:** Scatola singola,  
completa di viti  
e tasselli.

65012 TUBO DOCCIA L 80x80 CROM IND Art. A0148ACR P/C.1

65013 TUBO DOCCIA L 70x170 CROM IND Art. A0148BCR P/C.1



A 3 kat

L H P  
cm 70 70

Cromato

**IMBALLO:** Scatola singola,  
completa di viti  
e tasselli.

65014 TUBO DOC. U 70x70x70 CROM IND Art. A0148CCR P/C.1



**Thbo per tenda doccia**

Aousbox.

L H P  
cm 78 74

FINITURA: Cromato

**IMBALLO:** Scatola singola,  
completa di viti  
e tasselli.



65016 REGGIT.AQUABOX DOCC.0 CR IND Art. A01300CR P/C.1



**Thbo per tenda doccia**

Aquabox.

L 72    él    P 74  
cm

**FINITURE:** Cromato  
**IMBALLO:** Scatola singola,  
completa di viti  
e tasselli.

65017 REGGIT.AQUABOX DOCC.L CROMiND Art. A01310CR P/C.1

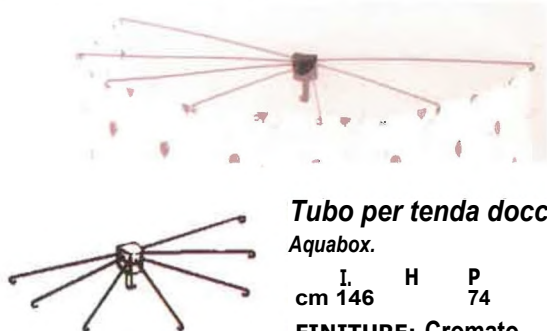

**Tubo per tenda doccia**

Aquabox.

I. 146    H    P 74  
cm

**FINITURE:** Cromato  
**IMBALLO:** Scatola singola,  
completa di viti  
e tasselli.

65018 RF,GGIT.AQUABOX VASC U CROM IND Art. A01320CR P/C.1



**Ancoraggio e soffitto,**

**Cromato**

L    H    P  
cm    60

**IMBALLO:** Scatola singola,  
completa di viti  
e tasselli.

65019 ATTACCO A SOFFITTO 60 CROM IND Art. A01470CR P/C.1



65033 TENDA VIN 8 GANCI 120x200 IND P/C.1

65034 TENDA VIN 11 GANCI 180x200 IND P/C.1

65035 TENDA VIN 15 GANCI 240x200 IND P/C.1



MANIGLIONE  
ottone cromato

TUV (1500N —150 kg)

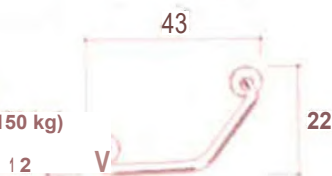

65039 MANIGLIONE 25 cm HANDY CRM IND Art. 491 P/C.1



**Fiocco di ricambio per scopini**

65040 FIOCCO RIC. x SCOPINO 3814 IND Art. 838140011 P/C.1



65042 RULLO PLASTICA C/MOL. BIAN IND Art. R03290 P/C.1



11 x 4 h x 7 cm

65044 REGGISAPOIVE A GRIGLIA IND Art. A05070CR003 P/C.1



Portasapone  
r» 100°69°

rr

cm 9 P

65258 PORTA SAPONE APPOGGIO BIAN IND Art. A05090BR P/C.1



SPANDISAPONE 0.5 LT  
ottone cromato  
con viti a vista



65045 SPANDI SAPONE A PULSANTE IND Art. EXP 567 P/C.1



**PORTAOGGETTI**  
con viti a vista

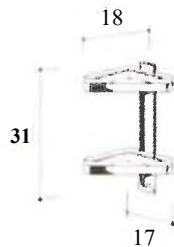

- 65043** PORTA OGGETTI ANG 2P CROM IND Art. A04320AL2 P/C.1  
**65255** PORTA OGG.ANG.2P BIAN IND Art. A4320BROZ P/C.1

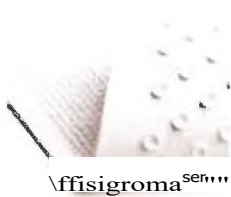

cm x 55 cm 40 x 90  
 Tappetino per doccia Tappetino per vasca

- 65051** TAPPETO DOCCIA 55x55 P/B/A IND Art. 198 P/C.1  
**65052** TAPPETO VASCA 40x85 B/V/P IND Art. 199/B P/C.1



29 x 4 h x 5 cm

- 65047** PORTA ABITO 3 GANCI CROM IND Art. EXP1225/3 P/C.1



07 x 11 h

- 65059** BICCHIERE APPOGGIO BIAN IND Art. COL 4401 P/C.1

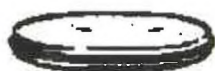

14x2hx11

- 65060** PORTA SAPONE APPOGGIO BIAN IND Art. COL 4402 P/C.1

**Accessori India Per Il Bagno Serie Colorelle**



8 x 11 h x 9 cm

- 65117** P.BICCHIERE COLORELLA CROM IND Art. A23100CRO3 P/C.1  
**65262** P.BICCHIERE COLORELLA BIA IND Art. A23100BR P/C.1  
**65244** BICCHIERE x COLOR/EXP BIAN IND Art. C.360 VETRO P/C.1



14 x 7 h x 14 cm

- 65118** P.SAPONE COLOR. TRAS SUP CR IND Art. A23110CRO3 P/C.1  
**65263** PORTA SAPONE COLOR.SUP BIA IND Art. A23110BR03 P/C.1  
**65245** BACINELLA x COLOR/EXP TRAS IND Art. C.311 VETRO P/C.1



19 x 21 h x 3 cm

- 65126** P.SALVIETTE ANEL.COLOR. CR IND Art. A2316TCR P/C.1  
**65265** P.SALV.ANEL.COLORELLA BIA IND Art. A2316TBR P/C.1



7 x 7 h x 43 cm

- 65119P** P.SALVIETSNODO COLOR.CROM IND Art. A23150CR P/C.1  
**65264** P.SALVIETTE SNODO COL. BIA IND Art. A23150BR P/C.1



cm 30 37 x 7 h x 8  
 cm 45 52 x 7 h x 8  
 cm 60 67 x 7 h x 8

- 65123** P.SALVIETTE COLOR.30 cm CR IND Art. A2390ACR P/C.1  
**65124** P.SALVIETTE COLOR.45 cm CR IND Art. A2390BCR P/C.1  
**65125** P.SALVIETTE COLOR.60 cm CR IND Art. A2390CCR P/C.1  
**65269** P.SALVIETTE 30 COLOREL.BIA IND Art. A2390ABR P/C.1  
**65270** P.SALVIETTE 45 COLOREL.BIA IND Art. A2390BBR P/C.1  
**65271** P.SALVIETTE 60 COLOREL. BI IND Art. A2390CBR P/C.1



13 x 12 h x 10 cm

- 65121** P.ROTOLO COLORELLA CROM IND Art. A23270CR P/C.1  
**65267** P.ROTOLO COLORELLA BIA IND Art. A23270BR P/C.1



20 x 7 h x 8 cm

- 65128 PROI OLO APERTO COLOR.CROMIND Art. A23250CR P/C.1
- 65273 P.ROTOLO APERTO COLOR.BIAN IND Art. A23250BR P/C.1



0 7 x 6 cm

- 65120 PORTA ABITO COLORELLA CROM IND Art. A23210CR P/C.1
- 65266 PORTA ABITO COLORELLA BIA IND Art. A23210BR P/C.1



24 x 7 h x 14 cm

- 65122 CEST.P.SPUGNA/SAP COLOR.CR IND Art. A23510CR P/C.1
- 65268 CESTINO P.SPUGNA/SAP. BIAN IND Art. A23510BR P/C.1



CESTINO  
ottone, cromato  
ca" viti a "1a 4

16

16

- 65131 CESTINO AD ANGOLO COLOR.CR IND Art. A04490CR P/C.1
- 65257 CESTINO AD ANGOLO BIAN IND Art. A04490BR P/C.1



• 21

55 x 88 h x 28 cm

-0

- 65116 PIANT.P.SALV.COLORELLA CR IND Art. A05840CR P/C.1
- 65274 PIANTANA P.SALVIETTE BIA IND Art. A05840BR P/C.1



wswe

55 x 57, x

- 65129 PIANTANA BASSA COLOR.CROM IND Art. A05850CR P/C.1
- 65260 PIANTANA BASSA COLOREL.BIA IND Art. A05850BR P/C.1



- 65127 PSCOPINO COMPL COLOR.CROMIND Art. A38140CR P/C.1
- 65272 PORTA SCOPINO COMPL. BIAN IND Art. A38140BR P/C.1



17 x 72 h n 28 cm

- 65130 P.SCOPINO+P.ROT.COLOR. CR IND Art. A23240CR P/C.1
- 65261 P.SCOPINO+ROTOLO COLOR.BLA IND Art. A23240BR P/C.1

Accessori inda Per 11 Bagno Serie Export Cromo



π  
L <7=e'''



- 65514 SUPPORTO VASC/BICC S/VETRO IND Art. 221000 P/C.1



Solo bicchiere  
In plastica

- 65549 BICCHIERE EXPORT PLAS.TRAS IND Art PL-110 P/C.1



**Solo bacinella  
in plastica**

**65550 BACINELLA EXPORT PLAS.TRAS** IND Art. PL.111 P/C. 1



5 x 7 h x 43 cm

**65517 P.SALVIETTE SNODO EXP.CRO** IND Art. A22150CR P/C.1



19 x 21 h x 3 cm

**65520 P.SALVIETTE ANELLO E., 2<sup>3</sup>.CRO** IND Art. A2216TCR P/C.1



cm 30 t5 x 8  
cm 45 \ i t i x 8  
cm 60 G h x 8

**65540 P.SALVIETTE 30 EXPORT CROM IND** Art. A2290ACR P/C.1

**65541 P.SALVIEITE 45 EXPORT CROM** IND Art. A2290BCR P/C.1

**65542 MANIGLIONE FISSO 60 cm** IND Art. A2290CCR P/C.1



13x 7hx10cm

**65532P.ROTOLO CHIUSO EXPORT CR** IND Art. A22260CR P/C.1



14 5/10

14 x 7 h x 11 cm

**65537 P.SAPONE C'ESTINO EXPORT CR** IND Art. A22490CR P/C.1



24 x 7hx14cm

**65539 PORTA SPUGNA/SAP A CESTINO** IND Art. A22510CR P/C.1

## Specchi Inda



SPECCHIO  
CON RIPIANO  
TRASPARENTE  
D'OTTIO

rom 31 51

50-60

13

**65049 SPECCHIO MET 60x51 CROM** IND Art. A0781 BCR P/C.1

**65050 SPECCHIO MET 50x51 CROM** IND Art. A0781ACR P/C.1



Con telaio. Spessore 3 mm.  
Con biseilo.

cm I H P  
70 90

**IMBALLO:** Scatola singola,  
completa di viti  
e tasselli.

**65577 SPECCHIO 70x90**

IND Art. A52350 P/C.1



Con telaio. Spessore 3 mm.  
Con biseilo

cm L H P  
60 80 3

**IMBALLO:** Scatola singola,  
completa di viti  
e tasselli.

**65579 SPECCHIO C/BISEL. 60x80**

IND Art. A07840 P/C.1



Con restio. Spessore 3 mm.  
(77, Con buel/°.

cm 60 H P  
80 3

**IMBALLO:** Scatola singola,  
completa di viti  
e tasselli.

**65580 SPECCHIO C/BISEL. 60x80**

IND Art. A21710 P/C.1

**inda**

IL SELLO DEL RAU K)



**PII** Bordo specchio da parete.  
Incandescenza 230V x 2 x 40W,  
lampadina esclusa Vetro satinato.



**L N P**  
cm 22 33 15

**IMBALLO:** Scatola singola,  
completa di viti  
e tasselli.

**65582 GRUPPO LAMPPAR. FA CROMO** IND Art. A0093ACR P/C.1



11)31 Bordo specchio da periste.  
Incandescenza 230V x 2 x 40W,  
~pedine escluse Vetro satinato.



**L H P**  
cm 29 25 19

**IMBALLO:** Scatola singola,  
completa di viti  
e tasselli.

**65583 GRUPPO LAMP.PAR. FB CROMO** IND Art. A0093BCR P/C.1



1P31 Bordo specchio con morsetto.  
Incandescenza. 230V x 60 W.  
lampadina esclusa. Vetro seti-  
nato.



**L H P**  
cm 8 13 11

**IMBALLO:** Scatola singola,  
completa di viti  
e tasselli.

Bianco azzurrato

**65585 FARETTO** CROMO IND Art. A00960BA P/C.1

### Lavali In Acciaio Inox Da Appoggio Ovvero Da Mettere Su Mobile

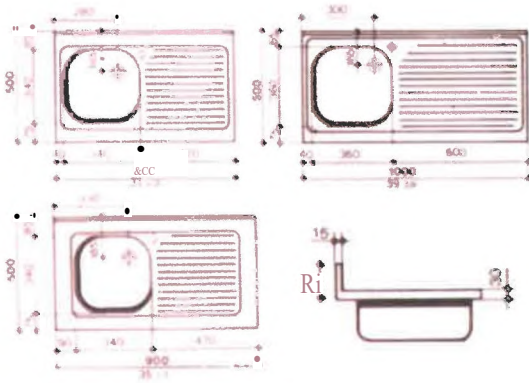

**65701 LAVELLO INOX SC/DS 80x50** MERArt. 718687 P/C.1

**65702 LAVELLO INOX SC/DS 90x50** MERArt. 718683 P/C.1

**65703 LAVELLO INOX SC/DS 100x50** MERArt. 718679 P/C.1



**65704 LAVELLO INOX SC/DS 120x50** MERArt. 718983 P/C.1

**114VS**  
Ne  
**GROUP**



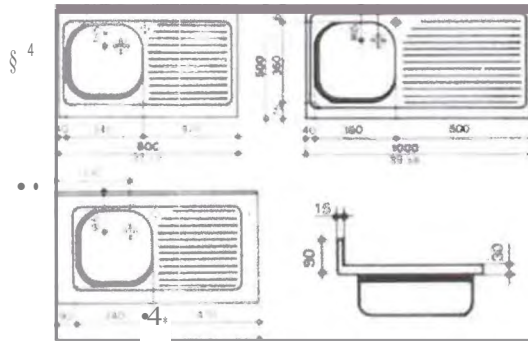
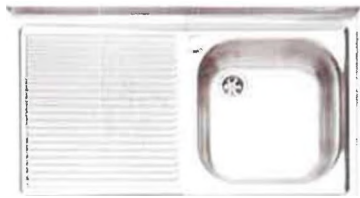

**65780** LAVELLO INOX SC/SN 80x50 MERArt. 718688 P/C.1

**65781** LAVELLO INOX SC/SN 90x50 MER Art. 718970 P/C.1

**65782** LAVELLO INOX SC/SN 100x50 MER Art. 718680 P/C.1



**65784** LAVELLO INOX SC/SN 120x50 MERArt. 718232 P/C.1

**Sottolavelli Per Ceramica Colore Bianco**

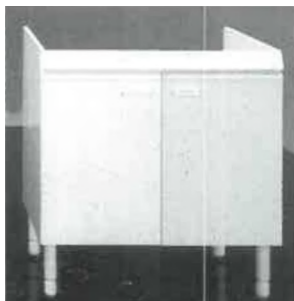

**65801** SOTTOL.x CERAM 80x45 BIAN PST Art. 605 P/C.1

**65802** SOTTOL.x CERAM 90x45 BIAN PST Art. 606 P/C.1

**65803** SOTTOL.x CERAM 100x45 BIAN PST Art. 607 P/C.1

**65806** SOTTOL.x CERAM 100x50 BIAN PST Art. 607 P/C.1

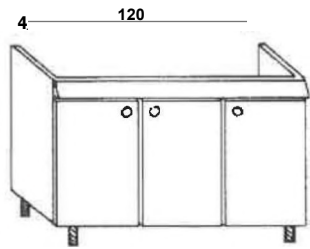
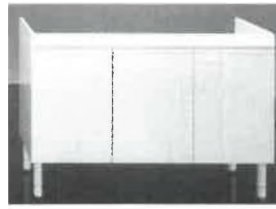

**65808** SOTTOL.x CERAM 120x50 BIAN Ps T Art. 608 P/C.1

**Sottolavelli Per Ceramica Colore Teak**

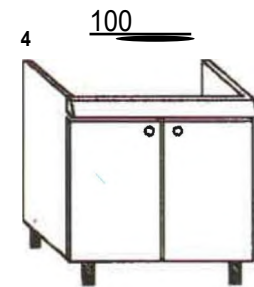

**65823** SOTTOL.x CERAM 100x45 TEAK PST Art. 607 P/C.1

**65826** SOTTOL.x CERAM 100x50 TEAK PST Art. 607 P/C.1

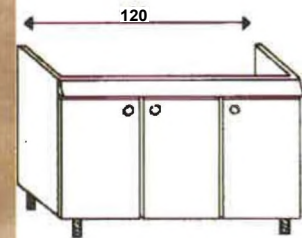

**65828** SOTTOL.x CERAM 120x50 TEAK PST Art. 608 P/C.1

**Sottolavelli Per Inox Colore Bianco**

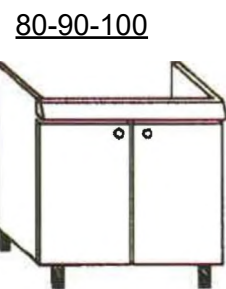

**65809** SOTTOL.x INOX 80x50 BIAN PST Art. 605 P/C.1

**65810** SOTTOL.x INOX 90x50 BIAN PST Art. 606 P/C.1

**65811** SOTTOL.x INOX 100x50 BIAN PST Art. 607 P/C.1

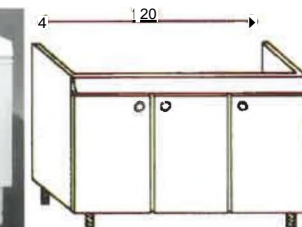
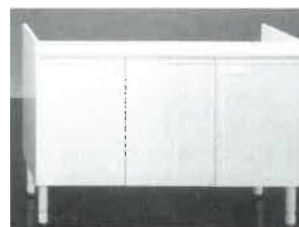

**65813** SOTTOL.x INOX 120x50 BIAN PST Art. 608 P/C.1

**Sottolavelli Per Inox Colore Teak**

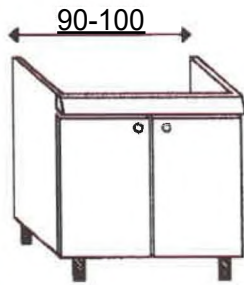

- 65830 SOTTOL. x INOX 90x50 TEAK PST P/C.1  
 65831 SOTTOL. x INOX 100x50 TEAK PST Art. 607 P/C.1

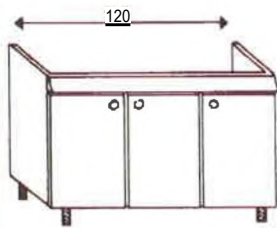

- 65833 SOTTOL x INOX 120x50 TEAK PST Art. 608 P/C.1  
**Mobili Con Lavello Inox Incorporato P/Lavast Montegrappa**

laellobb.



- 65918 SOTTOLAV.120 DXx LAVASTOV MTG Art. 230314001 P/C.1  
 65920 SOTTOLAV.120 SN x LAVASTOV MTG M. 230315001 P/C.1

**Mobili Con Lavello Inox Incorporato Montegrappa Serie Bassano**

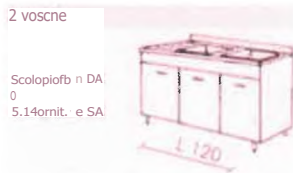

- 65956 MOBILE 3 SPORT 120 DS BIAN i MTG Art. 240214001 P/C.1  
 65957 MOBILE 3 SPORT 120 SN BIAN MTG Art. 240215001 P/C.1

**Montegrappa**

**Lavatoio Completo Di thoe In Termoplastico C/Cesto P/Blanchena Serie Lavello Montegrappa**



Struttura In nobilitato idrorepellente V100 con onte in trucidare postformato rivestito in laminato bianco.  
**CON ASSE TERMOPLASTICO**  
 DISPONIBILE:  
 - CON CESTO PORTABIANCHERIA  
 - SENZA CESTO PORTABIANCHERIA t

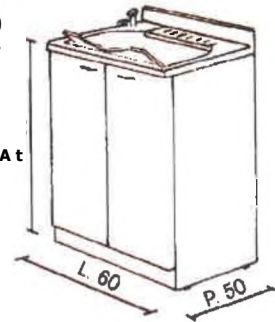

- 65986 MOBILE LA VAT. 60x50 C/CEST MTG Art. 140022000 P/C.1  
 65993 MOBILE LAVAT. 60x50 S/CEST MTG Art. 140020000 P/C.1



Snaturato In nobilitato idrorepellente V100 con onte in truciolare postformato rivestito in laminato bianco.  
**CON ASSE TERMOPLASTICO**  
 DISPONIBILE;  
 - CON CESTO PORTABIANCHERIA  
 - SENZA CESTO PORTABIANCHERIA

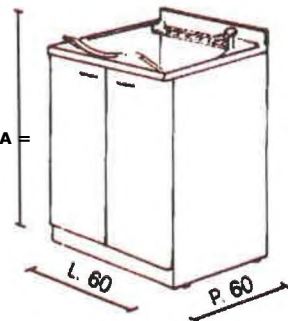

- 65991 MOBILE LAVAT. 60 cm C/CEST MTG Art. 140122000 P/C.1  
 65992 MOBILE LAVAT. 60 cm S/CEST MTG Art. 140120000 P/C.1

**[Non egrappa**



Struttura in nobilitato idrorepellente V100 con ante o trucidare posiformato investiti 10 in lamine bianco.  
**CON ASSE TERMOPLASTICO**  
**DISPONIBILE:**  
**- CON CESTO PORTABIANCHERIA**

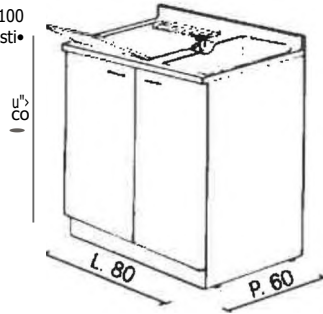

**65990 MOBILE LAVAT. 80 cm C/CEST** MTG Art. 140172000 P/C.1

**Lavatoio Completo Di Vasca In Termoplastico  
 C/Asse Plastica Serie Lavella Montegrappa**



6  
 85  
**LAVELLA 4D**  
 cerniere a destra  
**LAVELLA 4S**  
 cerniere a sinistra  
**LAVELLA 4DC**  
 cerniere a destra con cesto  
**LAVELLA 4SC**  
 cerniere a sinistra con cesto  
**VASCA IN TERMOPLASTICO**  
 con asse termoplastico o  
 legno a richiesta

**65998 MOBIL. LAVAT. 45X50 DX S/CES** MTG Art. 140.002.001 P/C.1

**Lavatoio Completo Di Vasca In Termoplastico  
 C/Asse Plastica Serie Lavella Montegrappa**



Struttura in nobilitato idrorepellente VI CO con ante in trucidare posiformato investiti 10 in laminato bianco.  
**CON ASSE TERMOPLASTICO**  
**DISPONIBILE:**  
**-SENZA CESTO PORTABIANCHERIA con**  
**CON CERNIERE A DESTRA**

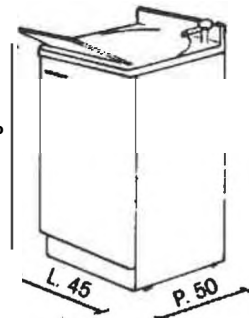

**65999 MOBILE x LAVAT. 109 BIAN** MTG Art. 142002000 P/C.1

**Mobiletto Porta Pilozzi in Gres  
 Per Lavanderia Montegrappa**

A



Pratico frontalino a ribalta.  
 Ghiera regolabili di livellamento  
**COLORE: bianco**

**65994 PILOZZO LAVATOIO PERU 45cm** MTG Art. 180002000 P/C.1

**65995 PILOZZO LAVATOIO PERU 60cm** MTG Art. 180120000 P/C.1

**Montegrappa**

**gmon egrappa.**

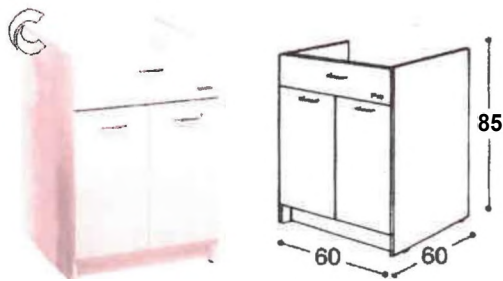

**65996** MOBILE C/LAVABO 70x50 BIANCO MTG Art. 120050000 P/C.1

**Mobiletto Porta Pilozzi In Gres  
Per Lavanderia Bencini**

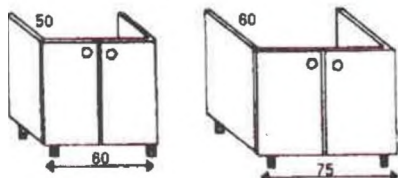

Per lavatoi "Messi o" DOLOMITE (vedi pag. 38)

**65842** MOBILE LAVAT MESSICO 75x60 PST Art. 508 P/C.1

**65843** MOBIL.LAV. MESSICO NUOVO 60 PST Art. 507 P/C.1



50

Per lavatoio "laide 60" Galassia  
(vedi pag. 23)

**65844** MOBILE LAVATOIO ISIDE PST Art. 507 P/C.1

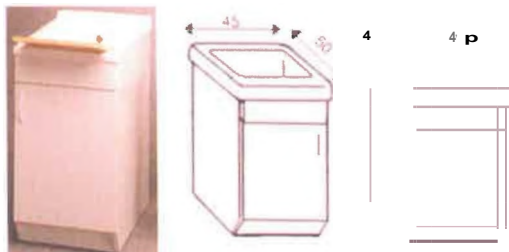

**66054** MLAVATOIO 45x50 TORRENT.B PST Art. 1201300 P/C.1

**66055** MLAVAT010 45x60 TORRENTB PST Art. 1211300 P/C.1

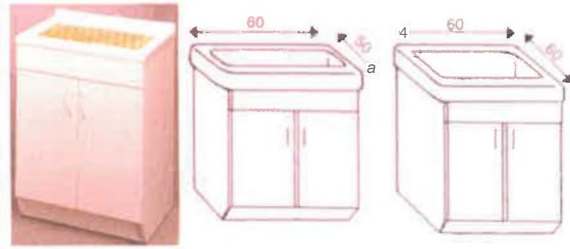

**66056** M. LAVATOIO 60x50 TORREMBI PST Art. 1221300 P/C.1

**66057** MLAVAT010 60x60 TORREN.BI PST Art. 1231300 P/C.1

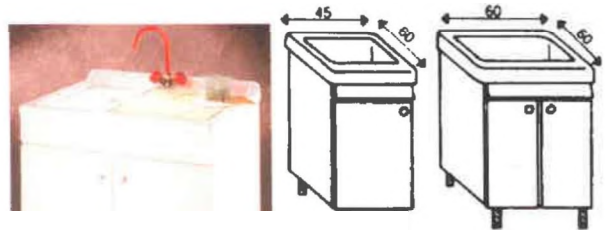

Mobile con lavatoio M acrilico  
ad alto spessore.  
Costruito in nobilitato idrofugo con ante  
curvate in laminato per una maggiore  
resistenza all'umidità.  
Colore: bianco

In dotazione:  
piatta sifone  
asse

Completo di lavello in plastica  
c/sportelli

**66050** MOBILE C/LAVAT 45x60 BIA PST Art. 102 P/C.1

**66052** MOBILE C/LAVAT 60x60 BIA PST Art. 104 P/C.1

**66063** ASSE IN LEGNO x LAVAT 60 DIW Art. 13099 P/C.1

**66401** ASSA x LAVATOIO 60 PST Art. 357130 P/C.1

**66402** ASSA x LAVATOIO 75 DIW P/C.1



**Scaldabagni Sitam Elettrici Verticali  
5 Anni Di Garanzia**



a:3

**Dell'4gilitati\*\*010111110,015\$Wellifk ~**  
 Tipo **A 5 C D** **Peso con Dimensioni Potenza d** **Tempo**  
Imballo 0c91 nnbilin 0") Watt dimm005mm/ tt 45 C

- 59575** SCALDAB. L50 EL VER VET 5A SIT Art. VH5I-50 P/C.1
- 59576** SCALDAB. L80 EL VER VET 5A SIT Art. VH5I-80 P/C.1
- 59577** SCALDAB. L100 EL VER VET5A SIT Art. VH5I-100 P/C.1

**Scaldabagni Boschetti elettrici verticali  
3 anni di garanzia**

e  
**1)joisi chietti**  
 linier  
 T'

Caratteristiche / Characteristics		Dimensioni / Dimensions		
Modello	Tensione/Voltage	Capacità/Capacity	Ø mm.	Altezza H mm.
1200	220-230	56	440	580
1300	220-230	80	440	780

- 54001** SCALDAB. ELET VERT 50L 3A **BST** Art. 91223100 P/C.
- 54002** SCALDAB. ELET YERT 80L 3A **BST** Art. 91223200 P/C.

**Scaldabagni Sitam Termoelettrici Verticali  
5 Anni Di Garanzia**



**Dati tecnici e ~sornioni d'ingombro gin min)**

ila+o A P/ e<< wmw.atm illo bruhrallo irnm) Wolt st 4, r.

- 59580** SCALDAB. L80 T/E VER DX 5A **SIT** Art. VHSTI-80 Dx P/C.1
- 59581** SCALDAB. L80 T/E VER SX 5A **sir** Art. VHSTI-80 Sx P/C.1

**Scaldabagni Sitam Elettrici Orizzontali  
2e5 Anni Di Garanzia**



**Tipo OR/F Garanzia 2 anni**

**Dati tecnici • dimensioni d'ingombro (in mm)**

Tipo **Peso con Dimensioni** **w.rtp** **ine0 rp**  
 (kg) tralabbo (mm) **.4cinmente**  
 815x500x500 **'kt 41 C**

- 59584** SCALDAB. L80 ORIZZ ELET 2A **SIT** Art. OR. 80F 82150F P/C.1

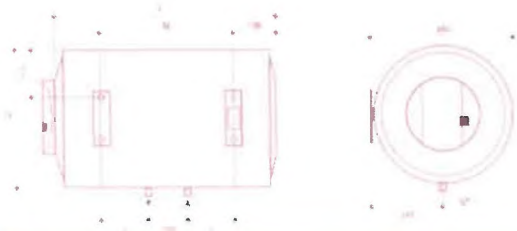

**Dati tecnici e dimensioni d'ingombro (in mm)**

Tipo	D	L	M	Entrata	Uscita	Potenza Watt	Tempo di riscaldamento t <sub>45°C</sub>
Elettrico 80	450	765	394	1/2"	1/2"	1200	4h 15'

59585 SCALDAB.L80 ORIZ EL VET 5A SIT Art. OH.80 P/C.1

**Scaldabagni Sitam A Gas Verticali  
3 Anni Di Garanzia**



CE t+411/4

**Dati tecnici e dimensioni d'ingombro (In mm)**

Tipo	A	B	C	D
50 V	373	<50	245	279
80 V	601	450	245	279
100 V	745	450	245	279
120 V	907	450	245	279

E: Entrata acqua fredda G 1/2"  
U: Uscita acqua calda G 1/2"  
G: Ingresso gas G 1/2"  
F: Scarico fumi (ø mm) 80

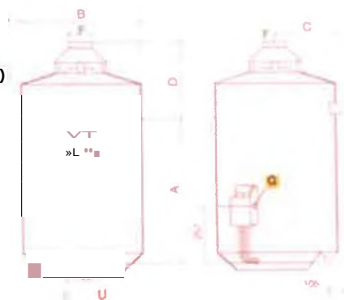

**Dati tecnici**

	50	80	100	t 20	
Capacità	Mn	4;	ai	98	
Potenza utile	kW	2,05	4,4	4,4	4,4
Tempo di riscaldamento (3T= 25C)	h, nn	0,54	0,58	1,13	1,28
Acqua a 40°C h un prelievo	rt n'eri	0,30	0,32	0,41	0,49
Consumo metano h 24 h senza pna bevi	Mtri	103	161	200	255
Pressione di esercizio	m"	0.37	0.56	0.56	0.55
Pressione di esercizio	bar	8	8	8	8
Peso netto	kg	24	30	34	40

\* in condizioni standard: 19°C, 1013 mbar

59610 SCALDAB. L50 GAS VET 3A SIT Art. APS.50 P/C.1

59611 SCALDAB. L80 GAS VET 3A SIT Art. APS-80 P/C.1

59612 SCALDAB. L100 GAS VET 3A SIT Art. APS-100 P/C.1

59613 SCALDAB. L120 GAS VET 3A SIT Art. APS-120 P/C.1

**Scaldabagni Sitam Verticali  
A Legna E Legnaelettrici  
3 Anni Di Garanzia**

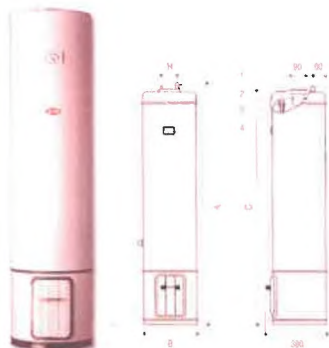

**Dati tecnici e dimensioni d'ingombro (in mm)**

Tipo	A	B	C	H	Entrata	Limita	Tempo di riscaldamento t <sub>45°C</sub>
Legna 80	1480	350	1440	100	1/2"	1/2"	1200
Legna elettrico 80	1480	350	1440	100	1"	1"	4h 30'

59661 SCALDAB. L80 LEGNA 3A SIT Art. 401 P/C.1

59662 SCALDAB. L80 LEGNA/ELET 3A SIT Art. 403 P/C.1

**Scaldabagni Boschetti a legna  
3 anni di garanzia**



Caratteristiche / Characteristics	Dimensioni / Dimensions
Legna Elettro, Wood Electric, Electrico	Capacità / Capacity
1000, ~220, 230	litri
	Ø mm
	H mm
	Attacco H2O
	1/2"

54015 SCALDAB. LEGNA PORC 80L 3A BST Art. 91300200 P/C.

**Pezzi Di Ricambio Per  
Scaldabagni Merloni**

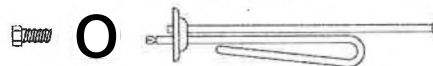

59783 RESIST x SCALD BLUK 50-80L MERArt. 816768 P/C.1

59784 RF, SI x SCALD PERL 10-15L MERArt 810786 P/C.1

59785 RESIST x SCALD PERL 30L MERArt. 810766 P/C.1



59786 TERMOST x SCALD BLUKER MERArt. 691069 P/C 1

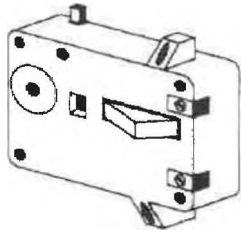

**59787** TERMOST x SCALD PERLINA MERArt. 691599 P/C. 1



**59789** TERMOST x SCALD PERLA MERArt. 691564 P/C. 1



**59796** PULSANTE ACCEND.PIEZO MERArt. 200254 P/C. 1



**59981** TERMOCOPPIA UNIVERS. L 600 CLB Art. 161-00060 P/C.1

**59982** TERMOCOPPIA UNIFIC. L 900 CLB Art. 161-00e80 P/C.1

**59983** TERMOCOPPIA UNIFIC. L1000 CLB Art. 161-00100 P/C.1



**Filettata**

**59984** RESISTENZA 1.1/4 1200 W CLB Art. 511-RT12D P/C.1

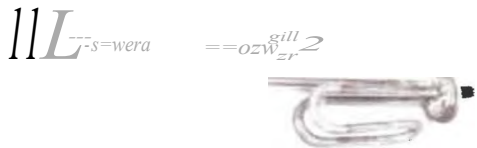

**Flangiata**

**59985** RESISTENZA FLANG. 1 200 DIR CLB Art. 605-RF12D P/C.1



**Scaldabagno Doccia 13 Lt Elettrico Radi**



**Dati tecnici e dimensioni d'ingombro (in mm)**

Tipo	A	B	C	D	Entrata	Uscita	Poten Watt	Tempo di riscaldamento t 45C
------	---	---	---	---	---------	--------	------------	------------------------------

T = con doccetta    C con beccuccio **sopralavello**

**59827** DOCCIA ELETT EUREKA T 13 L MERArt. 410672 P/C. 1

**59828** DOCCIA ELETT EUREKA C 13 L MERArt. 410897 P/C.1

**Scaldabagni Elettrici Bluker 2 Anni Di Garanzia (Economico)**



Veortkoh 50/80/100

Ortiz63618:- 33

**BLUKER 2 - garanzia 2 anni**

53V	510	33		536	Oi	'x , X 3e: 47	h	220
"ci"	lie i	366..7-	652	7.	ii.5	4ff	214	220
83O	738	338	453	AZC	'1'	/X + . . . 773 21 43	25:	220
88 NAV	1,1,3e	564.	250_173	165	4E0	t3C f 3C 210 4:	1: >X?	227
'05V	890	718	455	165	»O	lir. -c 7Ic zz	53:	22:
'000	890	310	42	680	"3	/t. /X		
V ...,		53:	3::	"M	<4.0	3E: 93 63		
8)toor	LUC 61C	\$35	35:	"Mi	IME"	3E0 48 63		
SME 1941	germis	awo	V...31.	C.Umareo.			'23:	233

- 59803 SCALD.RADI-BLUK EC L50 2A MERArt. 821115 P/C.1  
 59804 SCALD.RADI-BLUK EC L80 2A MERArt. 821116 P/C.1  
 59805 SCALD.RADI-BLUK EC L100 2A MERArt. 821117 P/C.1  
 59814 SCALDAB.BLUK.ORIZ EL 80 2A MERArt. 821118 P/C.1

**Scaldabagni Elettrici' Radi  
2 Anni Di Garanzia**



Dati tecnici	10 SP	10ST	15 W	15 ST	307	
Capautk	io	10	10	15	15	30
Peso netto	kg	6.5	6.5	1.1	7.1	11.2
Presone max esercizio	bar	8	8	8	8	8
Pceerua	W	1200	1200	1200	1200	1500
Vitaggio	V	230	230	230	230	230
Tempo ck nitaklarmento ST 45°C	min	30	30	45	45	70
Acqua calda 2 40°C dopo misceiadone	kin	16	16	24	24	45
Dispersa:in, temette m 24 h laT 50°C1	kwII	0.5	0.67	0.7	0.87	0.9

- 59800 SCALDAB. PERLINA L10 SP 2A MERArt. 820412 P/C.1  
 59801 SCALDAB. PERLINA L10 ST 2A MERArt. 820413 P/C.1  
 59817 SCALDAB. PERLINA L15 SP 2A MERArt. 820409 P/C.1  
 59802 SCALDAB. PERLINA L30 EC 2A MERArt. 820407 P/C.1

**Scaldabagni Elettrici Radi  
5 Anni Di Garanzia**



Dati tecnici	10W	10ST	15W	15ST	309	
CaPiElit	IO	IO	15	15	30	
PESO netto	kg	6.5	6.5	7,1	7.1	11.2
Pressione ma escano	bar	3	8	8	8	8
Potenza	V/	1200	1200	1200	1200	1500
~go°	V	230	230	230	230	230
Tempo di riscaklarmento .ST 45°C	min	30	30	45	45	70
kaua calda a 40PC dopo ~buone	*	16	16	24	24	45
Dispersioni termiche m24 h 01 seq	▶ Vih	0.5	0.67	0.7	0.87	0.9

- 59806 SCALDAR. PERLINA I,10 SP 5A MERArt. 820128 P/C.1  
 59807 SCALDAB. PERLINA L10 ST 5A MERArt. 820129 P/C.1  
 59810 SCALDAB. PERLINA L30 SP 5A MERArt. 820130 P/C.1

**Scaldabagni Elettrici Radi  
10 Anni Di Garanzia**



Dati tecnici	10 SP	10ST	15 SP	15 ST	307	
Capacità	len	10	10	15	15	30
Peso netto	ki;	6.5	6.5	7.1	1.1	11.2
Pressione max esercizio	Dar	8	8	8	8	8
Poteva	W	1200	1200	1200	1200	1500
Voltaggio	✓	230	230	230	230	230
Terni di riscaldamento .ST 45°C	min	30	30	45	45	70
Aroma calda a 4TC dopo macelamone	nei	16	6	24	24	45
Dispersioni termiche in 24 h 1ST 50°C1	KVIIh	0.5	0.67	0.7	0.87	0.9

- 59809 SCALDAI3.PERLINA L IO SP IOA MERArt. 820707 P/C.1  
 59813 SCALDAB. PERLINA 110 ST IOA MERArt. 820708 P/C.1  
 59811 SCALDAB. PERLINA L15 SP IOA MERArt. 820709 P/C.1  
 59812 SCALDAB.PERLINA L30 SP IOA MERArt. 820711 P/C.1

**Scaldabagni Elettrici Radi  
15 Anni Di Garanzia**



Dad tecnici	10W	10ST	15SP	15ST	»P	
Cap <sup>301a</sup>	IATI	10	10	15	15	30
Peso netto	tiq	6.5	6.5	7.1 •	7.1	11.2
Pressione cnak esercizio	bar	8	8	8	8	8
Potenza	W	1200	1200	1200	1200	1500
Miraggio	V	230	230	230	230	230
Tempo oi riscaldamelo .ST 45°C	miri	.10	30	45	45	70
Acqua calcia a 40°C dopo miscelanone	em	16	16	24	24	45
Dispersioni termiche le 24 h 1,17 50°C1	kw/h	0.5	0,67	9.1	0.87	0.9

- 59808 SCALDAB. PERLINA L15 SP SA MERArt. 820126 P/C.1  
 59815 SCALDAB. PERLINA L15 ST 2A MERArt. 820408 P/C.1



## Scaldabagni Elettrici Verticali Radi 3 Anni Di Garanzia



Caldaia in acciaio, testata a pressione di 12 bar.  
Protezione con doppio strato di zinco più multistrato.  
Isolamento poliuretano Zero CFC.  
Valvola di sicurezza idrica.  
Anodo di magnesio intercambiabile.  
Termostato di funzionamento dotato di 3<sup>^</sup> sicurezza prodotto in stabilimento certificato 150 9001.  
Spia funzionamento.  
Resistenza corazzata prodotta in stabilimento certificato 150 9001.



Modello	A	O	C	DE	Feer	ma	l	N	O	P
50V	553	450	100	-	170	100	310	165	.	.
80V	78	450	300	-	170	100	310	165	.	.
800	78	450	100	-	.	.	245	358	224	189
800/	78	450	100	401	350	170	1130	310	165	215
80M0	705	450	100	-	235	-	245	358	224	189
103V	933	450	100	-	170	100	310	165	.	.
ICOMV	933	450	100	553	350	170	100	310	165	245

Dati tecnici	50 V	800	1000	1000	1000	1000	1000
CaDat.5	bel	SC	80	80	79	79	100
neo nero	kg	17	223	22.3	25.2	26	78.5
Predone ma, eied93	bar	8	e	8	8	8	
Puma	W	1200	1200	1200	1200	1500	ISOC
Vataggio	V	230	230	230	230	230	230
re p9 01 Mcaliamento 41'	W	2125	3/50	3750	3150	3/50	7150
ACM calda a 406 0:0o momiumme	atri	75	120	120	118	118	150
Chance cerrade in 29 n AT 5064 0461	O22	1.02	1.12	1.02	1.12	1.26	1.26

**59835 SCALD. PERLA V/EL L 50 3A** MERArt. 842571 P/C.1

**59836 SCALD. PERLA V/EL L 80 3A** MERArt. 842572 P/C.1

## Scaldabagni Termoelettrici Radi Orizzontali 3 Anni Di Garanzia

- Caldaia in acciaio testata a pressione di 12 bar.
- Protezione con doppio strato di zinco più multistrato isolamento poliuretano Zero CFC.
- Valvola di sicurezza idrica.
- Anodo di magnesio intercambiabile
- Termostato di funzionamento dotato di 3<sup>^</sup> sicurezza prodotto in stabilimento certificato 150 9001
- Spia funzionamento.
- Resistenza corazzata orodotta in stabilimento certificato 150 9001

	50	80V	800	800/	8000	1005	100 IN
048 lemon							
IVAILTJ	abi		10	79	79	100	°.
5) Betre	ug	17	22.3	25.2	26	26	28.9
4...er n.4 n''>	tre	8	6	8	8	8	8
k.e.e,	W	1200	1203	1200	1200	1200	1200
4012990	V	230	220	230	200	140	750
6-6. nrixi~e6 Sr 456	ve,	2/25	3/50	3150	W0	3150	3/50
Acqua (dina a .0.0 dopo natalancre	.4-	75	120	120	336	118	350
Caperson 4-604 r i° n or UN	n7/n	082	1.02	1.12	1.02	1.12	1.24

**59838 SCALD.PERLA OR T/EL 80 D3A** MERArt. 842565 P/C.1

**59839 SCALD.PERLA OR T/EL 80 S3A** MERArt. 842579 P/C.1

## Scaldabagni Elettrici Radi Verticali 5 Anni Di Garanzia



- Cadaa acualiz tema a pretto:nese 16 kat ~nuore kkajj.iss
- Cabentanone poeuretano espanso a Zero CFC
- V4voda di IKLIEVA idrica
- Regolazione esterna temperanra da 40°C a 80°C trame 150 e 200 ktril
- Angelo ck magnesio intercammiatkie
- Termosrato al funzionamento dotato cil 3<sup>^</sup> sècurezza prodotto In stabilimente certificato 50 9001
- Spa funzionamento.
- Resistenza coraizzata prodotta in ~mento collimo 609001

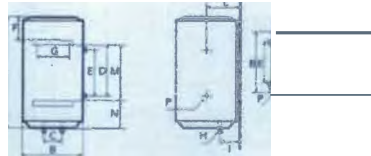

	B	I	MNO				
50V	535 495 103	214 150	329 G 112" 108				
80 V	Mie 495 100	214 150	129 G 1ft 108				
800	680 495 100		G1/2" 37 325 258 160				
80 MV	680 495 100 291 340 214	350	32961/2" rce c3/4				
100V	850 495 100	214 350	329 G 11" 106				
1000	850 495 100		G 1ff 257 258 160				
100 W	850 495 100 m	340 231 150	329 G112" 108 257 (.3/4)				
Dati teaid	50V	000	800	800?	1000	1000	1000
CaPadit	kg	50	80	80	79	100	100
Pese netti	kg	19	23	23	26	29	32
Premorte	Gr	8	8	8	e	8	8
Nenia	W	1200	1200	1200	1200	1500	1500
Voltaggio	V	230	230	230	230	230	230
tempo di riscaldamento 6T 45°C Wiroki	2/20	3/44	3/44	3/44	3/44	3/44	3/44
Acque cada a et+c dopo rriscelazione	75	120	320	118	150	150	1+8
DisperaOM termiche n 24 li ist siry	618/11	0.677	0.968	1.120	0.909	1.046	1.270

**59844 SCALD. PERLA V/EL L 50 5A** MERArt. 1342446 P/C.1

**59845 SCALD. PERLA V/EL L 80 5A** MERArt. 642447 P/C.1

**59846 SCALD. PERLA V/EL L100 5A** MERArt. 042451 P/C.1

## Scaldabagni Termoelettrici Orizzontali Radi 5 Anni Di Garanzia



- Lodai n ansa aroma o\*... ne al 16 fax / 011 ~ Ken "
- Oistenlanone n poeuretano manto a 'Leso GO'
- Ve8/01a di sicurezza lenta
- Regolazione esterru tengserama da 40K a 50°C (danne t % e ZOO >il
- Modo di magnesio eiterunalblie
- Tennoamo a IlirMIONan\*WS due di I" sicurezza prudono in siebereerreo ~do 50 9001
- Soia funzionamento
- Re ariacolazaa pacato ikabeimeMo smaltato 50 9001

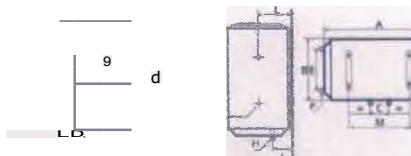

144041446	ARCDEF	G	H	I	6	8N	N	O	P
50V	535 495 100	214	150	329	G	IR	108	-	
80 V	680 495 100	-	214	750	329	G	117	'Ce	
80 O	690 495 100	-			G	1/7	157	325	258 160
80 UV	680 495 1130 291 340 214	150	329	0	1n	108	257	-	- 6311
100V	850 495 100	214	150	329	G	1/7	1a		
100 O	OSO 495 100				0	tir	257	258	160
10068/	850 495 100 291 340 274	150	329	G	1/2'	108	257		
040 tecnici		50V	80V	800	(066/	100V	1000	100	100 W
CaPaCIM	l	50	80	80	79	100	100	100	99
Peso netto	kg	19	23	23	26	29	29	32	32
erezione max esercizio	ber	8	8	8	8	8	8	8	8
Patema	W	1200	1200	1200	1200	1500	1500	1500	1500
Voltaggio	V	230	230	230	230	230	230	230	230
Tempo di riscaldamento 87 45 °C Mrin	2/20	3/44	3/44	3/44	3/44	3/44	3/44	3/44	3/44
Acqua calda a 40°C dopo	azione	75	120	120	118	150	150	148	
Dispersioni termiche	kwm	0.677	0.908	1.120	0.909	1.046	1.270	1.046	
n 24 h tir	50°C/1								

**59847 SCALD.PERLA T/EL DX L80 5A** MERArt. 842450 P/C.1

**59848 SCALD.PERLA T/EL SX L80 5A** MERArt. 842449 P/C.1

**59849 SCALD.PERLA T/EL DX L 1005A** MER Art 842444 P/C.1

**59850 SCALD.PERLA T/EL SX 1,1005A** MER Art. 842445 P/C.1

### Scaldabagni Gas Accumulo Radigas Economico Radi

Dati tecnici		50V	80V	100V	120V
Capacità	litri	47	76	96	116
Potenza utile	O:	2,95	4A	4,4	4,4
Tempo ai riscaldamento A' 25 c	min	30	32	42	49
Tempo di riscaldamento ST 45°C	mal.	54	58	73	88
Temperatura di esercizio	°C	103	167	211	1'25
Pressione di esercizio	bar	0,37	0,55	0,55	0,55
	15	1013	mbar		

Modello	A	B	C	E	F
COSMOS EURO 50 V	373	450	81	245	279
COSMOS EURO 80 V	601	450	81	245	279
COSMOS EURO 100 V	754	450	81	245	279
COSMOS EURO 120 V	907	450	81	245	279

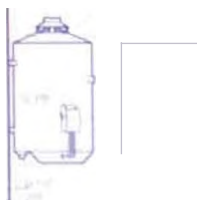

**59830 SCALDAB. RADIGAS 1,50** MER Art. 002210-PF45 P/C.1

**59831 SCALDAB. RADIGAS L.80** MER Art 003010 P/C.1

**59833 SCALDAB. RADIGAS L 100** MER Art. 004062 P/C.1

### Scaldabagni Gas Accumulo Supercosmos Radi



r G H i

**59824 SCALDAB. SUPERCOS. L50V 3A** MER Art. 002120 P/C.1

**59825 SCALDAB. SUPERCOS. L80V 3A** MERArt. 003028 P/C.1

**59826 SCALDAB. SUPERCOS. 1100V 3A** MERArt. 004017 P/C.1

## Scaldabagni Gas Accumulo Rettangolare Compatto Radi

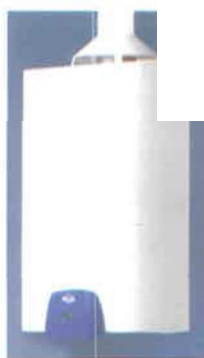

II F-SERDSATIVE SALIENTI  
II ILTIENETS MIESCI

... Irddip 174.  
II  
Acq  
subo  
Paga  
500  
...  
Paci  
e III  
Kin .bl. 11. 111.00 1. 1h.  
1111.21"  
... 11 eh  
1111.17111

Catiactta  
Potenza termica KW 6,2  
Potenza utile KW 44  
Tempi m rtm,lichuttinto ut 45°C - 42 i I h tntr C, 32  
Tempo di riscaldamento t T 25T - 42 h mio ci i ti  
thianlita etitttvalente a 444  
Consumo metano 0 55  
Consumo 901 • tyri alti  
Pressiont. MATtsith3 .I sSESJ:Q tu( 8  
Rencitmentt: 85\*  
Pesci netto lig 22  
a mm 937  
D mm 400  
mm

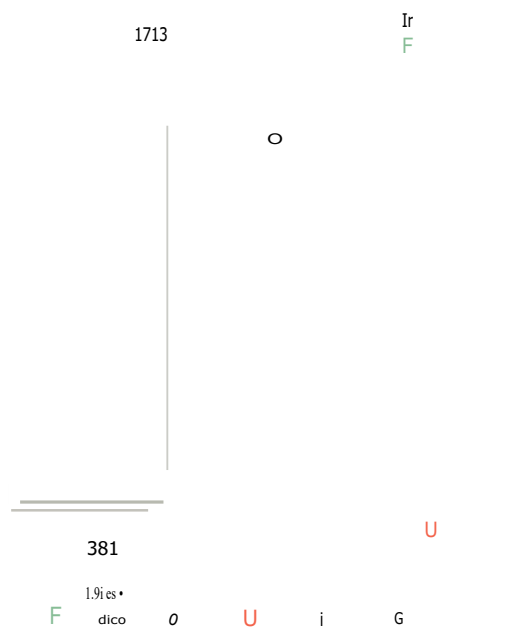

## Scaldabagni Gas A Terra Radi Accumulo Di Grande Portata



Dati tecnici 306 406 506 80 6  
9 • 5

rt 4 71  
30G-400-506 806



Morrle A 8 mm 1/12.  
COSMOS 30 G 4 9 5 11 17  
... 495 1361 230 175 , 5  
M514r,35 5<sup>3</sup> (t 61/ 230 7  
b.

- 59834 SCALDA B. GAS VER/PAVL 115 MERArt. 007700 P/C.1
- 59840 SCALDAB. GASPAVIML 155 MERArt. 007701 P/C.1
- 59841 SCALDAB. GASPAVIML 195 MERArt. 007702 50GM P/C.1
- 59842 SCALDAB. GASPAVIML 300 MERArt. 006122 P/C.1

59829 SCALDAB. GAS 45 L MIGRO MERArt. 002065 TON P/C.1

**Scaldabagni Gas Accumulo Flusso Bilanciato  
Supercosmos Radi**



Dati tecnici		80 V	100 V
(apdcita)	litri	15	95
Peso netto	kg	32	38
Pressione max esercizio		8	8
Portata termica nominale	kW	3.3	3.3
Potenza utile	kW	2.9	2.9
Tempo di riscaldamento .ST 15°C	mr	44	58
Tempo di riscaldamento .1145 °C	r	84	107
Acqua calda a 40°C dopo miscelazione	litri	16!	209
Consumo gas per riscaldamento ST 45 °C	m 'M	0 35	0.35
Metano (GPL)	ikgm	i0 26	10.26
Consumo: in 14h senza orci", Mularii	m-	0.27	0.31



Modello	A	8	C	D
SUPER COSMOS 80 FB	495	345	945	701
SUPER COSMOS 100 PB	100	395	1'15	847

**59822 SCALD. SUPER.FLBILL80V3A** MERArt. 0e6042 P/C.1

**59823 SCALD.SUPER.FLBILL100V3A** MERArt. 006043 P/C.1

**1111r3  
GROUP**

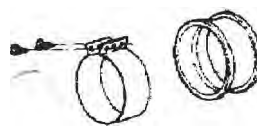

**59733 FASCETTA + MANICOTTO § 80 B1** MER Art. 705271

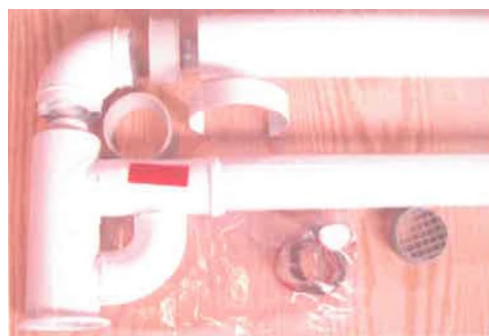

- A. Corpo edoppiatore
- R. Guavrtzforte in neoprene
- C. Tubo \*W Le1000 W/M (asp)
- O. Guarnizione\* labbro
- E. (xminale oS0 (aspirazione)
- P. Tappo per loro .35
- G. Falcetto amen& manicotto (\* vili)
- H. Manicotto tenuta tubo e100/curva coassiale
- L. Curva costatale 0100 M • Wo50 F-F
- L. OR e60 M tenuta
- M. Tubo aree Le50 Wel
- N. Tubo .100 Le995 WM
- O. Tubo 060 Le1025 11/P
- P. Molla distanziamici
- O. Cappa mia
- R. Riduzione lumi

**59757 SDOPPIATORE X S CALD BILANC** MERArt. 705507

**O-RING PER TUBO Ø 80**



**59764 0-RINGx SCAR/SDOPPIATO**

ATI Art. ORLOBS

**MrIS  
GROUP**

### Scaldabagni Gas Accumulo Flusso Forzato Radi Supercosmos (Tubo Coassiale Da 75 Cm Incluso)

**IP45**

- Massima protezione all'ingresso dell'acqua alle parti elettriche IP45. Per il più sicuro controllo degli impianti.
- Installazione semplice, veloce.
- Controllo in 40°C (standard).
- Anodi di magnesio.
- Isolamento in Polistirene espanso (EPS) 2000°C ad alta densità.
- Flussore in lega Alluminio-GAS.
- Progettato per Gas Metano con kit di trasformazione GPL.
- Regolazione temperatura da 40 a 72°C.
- Controllo gas con cartello elettronico e con flussore di sicurezza dotato di un'emissione di auto-temperatura sempre adeguata in caso di malfunzionamento o di rilevazione di gas.
- Accessorie a richiesta: sonda di temperatura, sonda di gas, sonda di pressione.
- Tre possibilità di installazione:
  - Verticale in camera stagna.
  - Orizzontale in camera stagna.
  - Orizzontale in camera stagna.



Dati tecnici		80 V	100 V
Capacità	litri	75	95
Peso netto	kg	35	49
Pressione max esercizio	bar	8	8
Portata termica nominale	kW	3.4	3.4
Potenza utile	kW	3.0	3.0
Tempo di riscaldamento M 25°C	min	44	58
Tempo di riscaldamento AT 45°C	min	84	107
Acqua calda a 40°C dopo miscelazione	litri	161	209
Consumo gas per riscaldamento	m <sup>3</sup> /in	0.36	0.36
AT 45°C Metano i.GP..!	kg/m <sup>3</sup>	10.267	(0.2671)
Consumo in 24h senza prelievi Metano	litri	0.23	

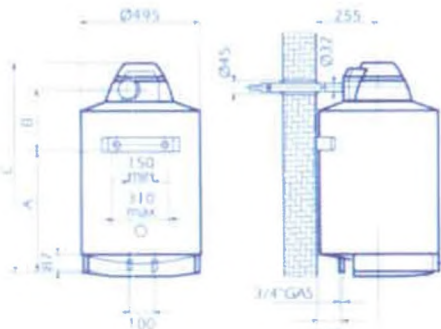

Modello	A	B	C
SUPER COSMOS 80 FFI	495	230	863
SUPER COSMOS 100 FFI	640	240	1018

**59820** SCALE). SUPER.FL.FOR.L80V3A MERArt. 006160 P/C. 1

**59819** SCALD. SUPER.FL.FOR.100L3A MERArt. 006161 P/C. 1

### Kit Sdoppiato Ff Per Scaldabagni Accumulo Tubi E Curve Merloni

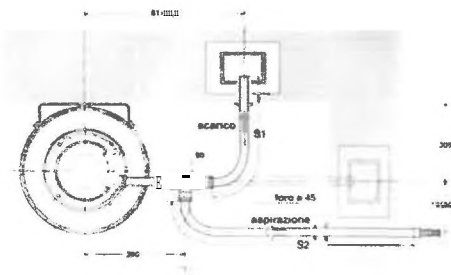
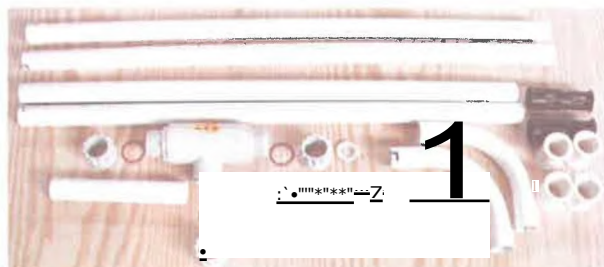

**59717** KIT SDOPPFUMI FFI ACCUM MERArt. 107996 P/C. 1

**59718** TUBO PROLUNG.FUMI §32 FFI MERArt. 107862 P/C. 1



**59719** CURVA SCAR.FUMI §32 FFI MERArt. 107863 P/C. 1

### Kit Scarico Coassiale Verticale Ff Per Scaldabagni Accumulo Radi

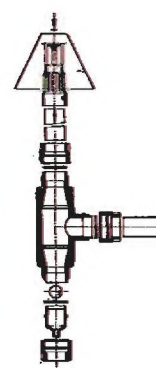

**59720** KIT SCARICO VERT § 32 FFI MERArt. 107861 P/C. 1

**Scaldabagno Rapido A Metano  
Radi Flusso Forzato**



1011/IFFI 13114FR

a  
U  
F

**Dati tecnici**

10MFFI 13114FR

Pressione minima ingresso gas Metano	mbar	<b>1b</b>	
Pressione minima ingresso gas Propano	Inbar	<b>37</b>	<b>37</b>
Consumi gas G PI 630/631	kg/il	<b>1 8</b>	<b>1 J</b>
Consumi gas G PI 630/631	kg/il	<b>4(3)</b>	
Pressione minima acqua	bar	<b>0.6</b>	<b>1 0</b>

59857 SCALD.RAP.FL/F0 IONO 10 L MERArt. 580014 P/C. 1

59858 SCALD.RAP.FL/F0 IONO 13 L MERArt. 580018 P/C. 1

**F FI - CAMERA APERTA  
TIRAGGIO NATURALE**

Accensione piezoslettrica (mod. F)

Accensione a batteria con controllo a ionizzazione di fiamme (mod. FI)

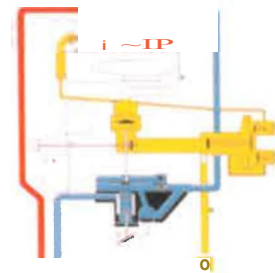

10F 13F 10F1

**Dati tecnici**

Pressione minima ingresso gas Metano	mbar	<b>1b</b>	
Pressione minima ingresso gas Propano	Inbar	<b>37</b>	<b>37</b>
Consumi gas G PI 630/631	kg/il	<b>1 8</b>	<b>1 J</b>
Consumi gas G PI 630/631	kg/il	<b>4(3)</b>	
Pressione minima acqua	bar	<b>0.6</b>	<b>1 0</b>

59852 SCALD.RAP.COSMOS D10 1A MERArt. 832616

59853 SCALD.RAP.COSMOS D13 1A MERArt. 832618

59855 SCALD.RAP.RHD 10 FjGPL MERArt. 560011



**Kit Coassiale Verticale Ff  
Per Scaldabagni Rapidi Merloni**

## KIT COASSIALE VERTICALE 1400

### COMPOSIZIONE:

- Tubi concentrici Ø 60/90  
lunghezza = 1400 mm

**59713K/T VERT. SGI FF L=1400**

**MER** Art. 705277 P/C. 1

**Kit Sdoppiato Ff Per Scaldabagni Rapidi Merloni**



**59714MT SDOPP.FUMI SGI FF RAP**

**ATI** Art. S08080513 P/C.1

**Scaldabagni Rapidi Tiraggio Naturale  
Accensione Piezo**



Nese:ioni

**59440 SCALD UNYC 11 METANO**

**SYL** Art. S00035 P/C.1

**59441 SCALD UNYC 11 GPL**

**SYL** Art. S00036 P/C.1



Tipo G.

Ihnrwati

**59442 SCALD UNYC 14 METANO**

**SYL** Art. 500084 P/C. 1

**Scaldabagni Rapidi Tiraggio Naturale  
Accensione Elettronica A Pila**

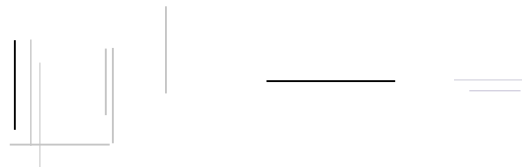

**59439 SCALD UNYC 11 IEB GPL**

**SYL** Art. S00074 P/C.1



**Scaldabagni Rapidi Tiraggio Forzato  
Accensione Elettronica**



Modello	W	Scaldabagni	ACAD
59445	13	13	13
59446	13	13	13

tipo gas	Metano	GPL
59445	13	13
59446	13	13

Dimensioni	
Altezza	130
Larghezza	400
Profondità	130
Peso Netto	13
Peso Lordo	13

**59445 SCALD DEVYL 13 LE.FF MET** SYL Art. 1550393 P/C.1

**59446 SCALD DEVYL 13 LE.FF LIQ** SYL Art. 1550395 P/C.1

**Accessori Per Devyl**



**59450 KIT COASSIALE A PARETE** SYL Art. 1550109 P/C.1

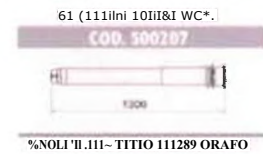

**59452 KIT COASSIALE A TETTO** SYL Art. 1550119 P/C.1



**59453 TEGOLA TETTO INCLINATA 41°** SYL Art. 1550169 P/C.1



**59466 PROLUNGA COASSIALE § 100** SYL Art. 1550129 P/C.1

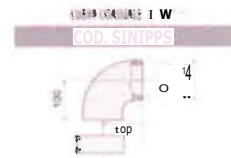

**59467 CURVA COASSIALE 90°** SYL Art. 1550139 P/C.1

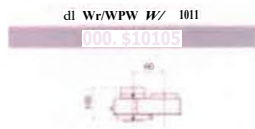

**59460 KIT SDOPPIATO** SYL Art. 1550229 P/C.1

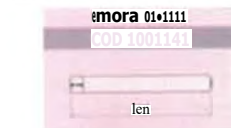

**59470 PROLUNGA § 80** SYL Art. 1550269 P/C.1



**59471 CURVA § 80 90°** SYL Art. 1550249 P/C.1

**Ricambi Scaldabagni Skarn**



**59900 GUARNIZIONE x RESISTENZA** SIT Art. 570118 P/C.1



**59901 GUARNIZIONE INTEGR x FLANG** SIT Art 570393 P/C.1

**59902 GUARNIZIONE § 98x37** SIT Art. 469068 P/C.1



**59903 GUARNIZIONE ANELLO 125x102** SIT Art. 469072 P/C.1



**59904 ACCENSIONE LAMPADA SPIA** sir Art. 469104 P/C.1



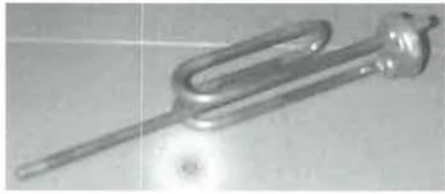

**59906 RESISTENZA 1200 FLANG NUOV** SIT Art. 810316 P/C. 1



**59907 TERMOMETRO x SCALD ELE7TR** Sir Art. 573427 P/C. 1

**59908 TERMOMETRO x APS** SIT Art. 469183 P/C. 1

**59909 TERMOMETRO x VHST - VE TON** SIT Art 570394 P/C. 1

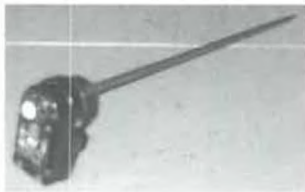

**59910 TERMOSTATO M270 RS** SIT Art. 695552 P/C. 1



**59911 TERMOSTATO NUOVO SITAM** SIT Art. 697113 P/C. 1



**59912 TERMOST x VHSI LEVA/BIA/BA** SIT Art. 691692 P/C. 1



**59945 ANODO L350 M6 FLAN** SIT Art. 469001 P/C. 1



*Valvola per scaldabagni*

**59946 VALVOLA SCALDAB. GAS ACC** SIT Art. 230271 P/C. 1



*Attacco maschio n. 8.*

**59947 ANODO PASSO M8 NUOVO** SIT Art. 570285 P/C. 1



*Originale* 

**59948 TERMOCOPPIA** SIT Art. 200165 P/C. 1



*Cm. 75, attacco 1,1/2" filettato*

**59949 RESIST. SCALD. LEGNA-ELETT** SIT Art. 469153 P/C. 1



**59986 VALVOLA SICUREZZA 3/8** CLB Art. 510-00038 P/C. 1

**59987 VALVOLA SICUREZZA Itif 1/2** CLB Art. 510-00012 P/C. 1



**VALVOLE PER SCALDABAGNO**

*Tipo pesante con funzioni di ritegno, sicurezza e scarico. Attacchi: MF 7/2" - MF 3/4". In ottone sbiancato. Confezioni da 10 pezzi.*

**70186 VALVOLA x SCALD.SIC MF 3/4** TIR Art. 6458000S34 P/C. 1



**59788 VALVOLA SICUR F3/4 x 1/2M** MERArt. 230224 P/C. 1



**Griglie Di Areazione Tonde In Plastica C/Molle**



Griglia tonda cOn rete (anti-insetti) e con molla

TUR 125	135	80+125	10	100	16	24
TUR 160	175	125-160	14	135	20	24
TUR 200	235	165-220	17	220	30	12

\*\*Legge 46/90 (6 cm<sup>2</sup> x 1000 watt)

- 21910 GRIGL.O/RETE TONDA §80-125 EDP Art. GTM 80 P/C.4
- 21912 GRIGL.O/RETE TONDA § 125-160 EDP Art. GTM 160 Pi.C.4
- 21914 GRIGL.C/RETE TONDA §160-200 EDP Art. GTM 200 P/C.6

**Griglie Di Areazione Tonde In Plastica**



Griglia tonda con rete (anti-insetti) e con molla

TUR 125	135	80-125	10	100	16	24
TUR 160	175	125-160	14	135	20	24
TUR 200	235	165-200	17	220	30	

\*\*Legge 46/90 (6 cm<sup>2</sup> x 1000 watt)

- 21922 GRIGL.C/RE/MOL TON §135 RA EDP Art. TUR125RA P/C.6
- 21923 GRIGL.C/RE/MOL TON §175 RA EDP Art. TUR160RA P/C.6
- 21924 GRIGL.C/RE/MOL TON §235 RA EDP Art. TUR200RA P/C.6

**Griglie Di Areazione Tonde In Rame C/Molle**



Griglia tonda in metallo con rete (anti-insetti) e con molla

GRA fu 125R 1131 rame' 80+125 I	8	55	19	36
GRA TU 160R 175 rame 125-160	8	30	13	24

\* \*Carico di lavoro come da Legge 46/90 (6 cm<sup>2</sup> x 1000 watt)

- 21937 GRIGL.RAM-FRET TONDA §135 EDP Art. GRA TU125R P/C.36
- 21938 GRIGL.RAMI-RET TONDA §175 EDP Art. GRA TU160R P/C.24

**Griglie Di Areazione Tonde In Alluminio C/Molle**

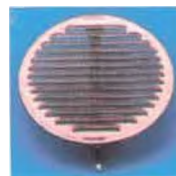

Griglia tonda in metallo con rete (antri-insetti) e con molla

GAL TU 125R I 131allun	80	125	55	19	36
GAL "r0 160R 1175 all'un	125.160	8	80	13	24

\* "Carico di lavoro come da Legge 46/90 (6 cm<sup>2</sup> x 1000 watt)

- 21939 GRIGLALL+RET TONDA §135 EDP Art. GZK TU125R P/C.36
- 21940 GRIGLALL+ RET TONDA §175 EDP Art. GAL TU160R P/C.24

**Griglie Di Areazione Tonde In Rame Incasso**



Griglie tonde In rame da Incasso con rete antiinsetti

Modello	Ø esterno mm	Ø imbocco mm	Passaggio Aria cm'
GTR 80R	100	80	30
GTR 100R	110	95	45
GTR 125R	125	115	65
GTR 140R	175	135	95
GTR 150R	175	145	108
GTR 200R	220	188	202

- 21941 GRIGL.RAM+ RET INC T080-100 EDP Art. GTR SOR P/C.30
- 21942 GRIGL.RAMI-RET INC TO95X110 EDP Art. GTR 100R P/C.30
- 21943 GRILL. RAM' RET INC 115X125T EDP Art. GTR 125R P/C.24
- 21944 GRIGL.RAA44 RET INC 135X175T EDP Art. GTR 140R P/C.24
- 21945 GRIGL.RAM1 RET INC 145X175T EDP Art. GTR 150R P/C.24
- 21946 GRIGL.RAM+ RET INC 188X220T EDP Art. GTR 20013 P/C.18

**Griglie Di Areazione Rettangolari In Plastica C/Molle**



Griglia in plastica con rete (anzi-insetti) e con molla

IAMR 200 120x230	140+2001	20	180	30	3
B.MR 140 183x154	100+140	20	100	16	48

\*\*Legge 46/90 (6 cm<sup>2</sup> x 1000 watt)

- 21916 GRIGL.O/RETE. RETT.204x230 EDP Art. AMR200B P/C.36
- 21918 GRIGL.O/RETE. RETT.183x154 EDP Art. BMR140B P/C.48



DESCRIZIONE	Q	CONF.
whau€ nericmckAn'	2:0z155	40
DA,Ne mo	370a130	40

ortform1 alle norme  
**UNI - CIG - 5A5**

- 21919** GRIGLIA PL RET INC 370X130 EDP Art. GAMA  
**21920** GRIGLIA PL RET INC 200X150 EDP Art. GAMA

DESCRIZIONE	Q	CONF.
-------------	---	-------



GRIGLIE QUADRE LA sovagppoRef, "Cr; v	230x230	60
---	---------	----

canformn. alle norme  
**A5**

- 21921** GRIGLIA PL QUADRA 230X230 EDP Art. GAMA

**Griglie Di Areazione Rettangolari In Rame Cit4t1**



**Griglia in metallo da applicare con rete**

Codice	Metano	Mimo,*	met. atm	l'as.. aria cm'	Pc. h con.
GRA IOR	Rame	140x140	5	40	10
GRA 24R	Rame	240x240	5	170	10

\*•Legge 46/90 (6 cm2 x 1000 watt)

- 21925** GRIGL RAM+RET QUAD 140x140 EDP Art. GRA 10R P/C.10  
**21932** GRIGL RAM+RET QUAD 240x240 EDP Art. GRA 24R P/C.10



**Griglia in metallo da applicare con rete**

(*udire	Molano	Mit un.	Spe, mut	l>xv.. ari.'cm'	Pr, i con.
GRA 20R	Rame	240x140	5	80	10

"Legge 46/90 (6 cm2 x 1000 watt)

- 21926** GRIGL RAM+RET RETT 240x140 EDP Art. GRA 20R P/C.10

**/=2/Lik**  
**PLAST**



**Griglia verticale in metallo da applicare con rete**

%tetano	%I bue. men	Spe. men	l>v..* Aria cm	Pc. % n'e
Rame	340x140	5	85	10

"Legge 46/90 (6 cm2 x 1000 watt)

- 21927** GRIGL RAM+RET RETT' 340x140 EDP Art. GRA 30R P/C.10



**Griglia in metallo da applicare con rete**

Codice	Nicioilo	Misuro	Soc. mm	Pois. aria cm'	Pi. i rimi
GRA 5424R	Rame	540x240	5	425	

"Legge 46/90 (6 cm2 x 1000 watt)

- 21934** GRIGL RAME RETTANG 540x240 EDP Art. GRA 5424 P/C.5



**Griglia verticale in metallo da applicare con rete**

l' mmm**	'artAL.	l' It.tire	4 INC. mm	l' v. * 41,3 pmm	P, i Jimi
GRA 1424R	Rame	140x240	5	85	10

"Legge 46/90 (6 cm2 x 1000 watt)

- 21931** GRIGL RAM+RET RETT 140x240 EDP Art. GRA 1424R P/C.10



**Griglie rettangolari 500 x 227 mm**

Realizzate in plastica

Spessore: 20 mm

Passaggio aria: 500 cm<sup>2</sup>

Colore bianco

AR 5023B Griglia con rete

AMR 50238 Griglia con rete e con molla

- 21935** GRIGL RETT C/RETE 500x227 EDP Art. AR 5023B P/C.5

- 21936** GRIGL RET C/RE/MOL 500x227 EDP Art. AMR 502313 P/C.5

### Griglie Di Areazione Rettangolari In Rame Da Applicare



**Griglie quadrate da sovrapporre**  
Griglia in lamiera ferrosa  
**Spessore: 5 mm**  
**Dimensioni: 140 x 140 mm**  
**Passaggio aria: 40 cm<sup>2</sup>**  
**Colore bianco**

BIANCO  
RAL 9016

21950 GRIGELAM+RET QUAD 140x140 EDP Art. GL 10RB P/C.10



### Griglie rettangolari da sovrapporre

Griglia in lamiera ferrosa CON RETE ANTIINSETTI

Spessore: 5 mm

Colore bianco N

GL 20RD

Dimensioni 240 x 140 mm

Passaggio aria: 80 cm<sup>2</sup>

GL 30RB

Dimensioni: 340 x 140 mm

Passaggio aria: 120 cm<sup>2</sup>

21951 CRIGL.LAM+RET RETT 240x140 EDP Art. GL 20RB P/C.10

21952 GRIGELAM-1-RET RETI 340x140 EDP Art. GL 30RB P/C.10

### Telaio Per Incasso Griglie Di Ventilazione



21965 TELAIO LAMZINC mm 104x104 EDP Art. CT 1010 P/C.8

21966 TELAIO LAM ZINC mm 146x83 EDP Art. CT 1483 P/C.4

21967 TELAIO LAMZINC mm 146x146 EDP Art. CT 1414 PIC.8

### Imbuto Di Raccordo Rett-Tondo Per Griglie Di Ventilazione



21971 RACC 100x100 QUAD xTOND100 EDP Art. IMB 1010100 P/C.1

21972 RACC 140x140 QUAD xTOND100 EDP Art. IMB 1414100 P/C.1

### Griglie Di Ventilazione Rettangolari In Bronzo

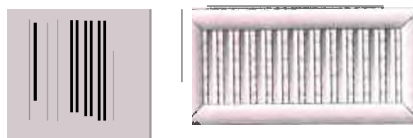

### Con valvola apri e chiudi

135x135: foro 96x96, profondità 79, m<sup>3</sup>/h 96

178x115 : foro 138x75, profondità 79, m<sup>3</sup>/h 106

175x175: foro 137x137, profondità 79, m<sup>3</sup>/h 200

21960 GRIGL.BRONZ C/SERR 135x135 EDP Art. GBRS 1010 P/C.6

21961 GRIGL.BRONZ C/SERR 178x115 EDP Art. GBRS 1483 P/C.4

21962 GRIGL.BRONZ C/SERR 175x175 EDP Art. GBRS 1414 P/C.6

### Ventilatore Per Estrazione Aria Bagni Temporizzato Technik



modelle,

8-10M

8-12M



### Con Timer Incorporato

59100 ESTRAT.INC.C/SERR 5100 T. TCH Art. B 10 MT P/C.1

59101 ESTRAT.INC. USER §120 T TCH Art. B 12 MT P/C.1

**PLAST**

**Tubo Flessibile Alluminio Bianco**



**ALLUMINIO VERNICIATO**

**Costruzione:** Verniciatura con polveri epossidiche bianco/moro

**Spesa. lamina:** 150 pm 120 lan

**Temp. d'impiego:** Fino a + 200°

**Caratt.** Prodotti preferiti in ambienti domestici per necessità di ambientazione, estetica, ecc.

**Campi d'impiego :** Impianti di aspirazione fumi per seppe.

13813	TUBO PIEGHETT BIAN	§ 80	MRL	P/C.6
13814	TUBO PIEGHETT BIAN	§ 90	MRL	P/C.6
13815	TUBO PIEGHETT' BIAN	§100	MRL	P/C.6
13816	TUBO PIEGHETT BIAN	§110	MRL	P/C.6
13817	TUBO PIEGHETT BIAN	§120	MRL	P/C.6
13818	TUBO PIEGHETT BIAN	§130	MRL	P/C.6
13819	TUBO PIEGFIETTBIAN	§140	MRL	PC.6
13820	TUBO PIEGHETT' BIAN	§150	MRL	P/C.6
13821	TUBO PIEGHETT BIAN	§160	MRL	PC.6

**Tubo Flessibile Alluminio Naturale**



**ALLUMINIO NATURALE**

**Costnalone:** Lega 3003 Alluminio al 99,9

**Spess. lamina:** 150 fan 120 ian

**Temp. d'impiego:** Fino a 4. 300°

**Caratt.** Prodotti di elevata qualità per robustezza Alta flessibilità, praticità di facile lavorazione.

**Campi d'Impiego :** Impianti di condizionamento, di aerazione e ventilazione, scarico fumi, cucine, ospedali, scuole, stabilimenti. Aspirazione fumi compatibili con il materiale in laboratori, industrie tessili, tipografie, tintorie, lavanderie, ecc.

13850	TUBO PIEGHETTALLUM § 80	MRL	P/C.6
13851	TUBO PIEGHETTALLUM § 90	MRL	P/C.6
13852	TUBO PIEGHETTALLUM § 100	MRL	P/C.6
13853	TUBO PIEGHETTALLUM § 110	MRL	P/C.6
13854	TUBO PIEGHETTALLUM § 120	MRL	P/C.6
13855	TUBO PIEGHETTALLUM § 125	MRL	P/C.6
13856	TUBO PIEGHETT ALLUM § 130	MRL	P/C.6
13857	TUBO PIEGHETTALLUM § 140	MRL	P/C.6
13858	TUBO PIEGHETTALLUM § 150	MRL	P/C.6
13859	TUBO PIEGHETTALLUM § 160	MRL	P/C.6

13861 TUBO PIEGHETTALLUM § 180 MRL P/C.6

13862 TUBO PIEGHETTALLUM § 200 MRL P/C.6

**Rosoni In Lamiera Stampata Bianchi Smaltati**

**In lamiera smaltata. Colore Bianco. O da 8 a 20 cm**

13202	ROSONE STUFA BIANCO N8	MRV Art. 1785 B	P/C.10
13203	ROSONE STUFA BIANCO N9	MRV Art. 1785 13	P/C.10
13204	ROSONE STUFA BIANCO N10	MRV Art. 1785 B	P/C.10
13205	ROSONE STUFA BIANCO N II	MRV Art. 1785 B	P/C.10
13206	ROSONE STUFA BIANCO N 12	MRV Art. 1785 B	P/C.10
13207	ROSONE STUFA BIANCO N 13	MRV Art. 1785 B	P/C.10
13208	ROSONE STUFA BIANCO N14	MRV Art. 1785 B	P/C.10
13209	ROSONE STUFA BIANCO N15	MRV Art. 1785 B	P/C.10
13210	ROSONE STUFA BIANCO N16	MRV Art. 1765 B	P/C.10
13211	ROSONE STUFA BIANCO N18	MRV Art. 1785 B	P/C.10
13212	ROSONE STUFA BIANCO N 20	MRV Art. 1765 B	P/C.10

13231 COLLAR REG TUBI BIAN 8-14 MRV Art. 1778 P/C.10

**Tubo Inox X Camini Pezzi Da 1,5 Mt**



	ACCIAIO INOX
Costruzione	Al& 318 ad atto tenore di Titanio
Spessore Lamina	120 um
Temperature d'impiego	Fino a +700 °C
Caratteristiche	Prodotti con caratteristiche di alta resistenza termica, meccanica e chimica
Campi d'impiego	Impianti aria calda, condizionamento ventilazione - Aspirazione di tunnels - Gallerie e banchi di saldatura Raccordi caldaie Fumi e fumane non corrosivi Camini

13870 TUBO PIEG.INOX 1.5 m §140 MRL P/C.1

13871 TUBO PIEG.INOX 1.5 m §160 MRL P/C.1

13872 TUBO PIEG.INOX 1.5 m §180 MRL P/C.1

13873 TUBO PIEG.INOX 1.5 m §200 MRL P/C.1

13874 TUBO PIEG.INOX 1.5 m §220 MRL P/C.1

13875 TUBO PIEG.INOX 1.5 m §250 MRL P/C.1

13876 TUBO PIEG.INOX 1.5 m §300 MRL P/C.1

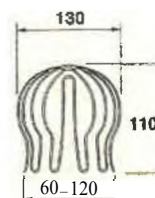

13261 PARAFOLIA ZINCATA §60-120 ETE Art. 0002 P/C.1

### Cassette Per Contatori Zincate



Disponibile in lamiera zincata  
Spessore lamiera: 7/10"

- |   |                        |       |
|---|------------------------|-------|
| <b>13303</b> CASSETTA CONT ZIN 30x40x25 | <b>FRR</b> Art. 040323 | P/C.1 |
| <b>13304</b> CASSETTA CONT ZIN 50x40x25 | <b>FRR</b> Art. 040316 | P/C.1 |
| <b>13305</b> CASSETTA CONT ZIN 60x45x25 | <b>FRR</b> Art. 040138 | P/C.1 |
| <b>13310</b> CASSETTA CON ZINC 60x50x25 | <b>FRR</b>             | P/C.1 |

### Cassette inox per contatori



Disponibile in lamiera di acciaio inox

- |  |                        |       |
|--|------------------------|-------|
| <b>13307</b> CASSETTA CON INOX 30x40x25  | <b>FRR</b> Art. 040324 | P/C.1 |
| <b>13308</b> CASSETTA CON INOX 50x40x2.5 | <b>FRR</b> Art. 040313 | P/C.1 |
| <b>13309</b> CASSETTA CON INOX 60x40x25  | <b>FRR</b> Art. 040310 | P/C.1 |
| <b>13306</b> CASSETTA CON INOX 60x45x25  | <b>FRR</b>             | P/C.1 |
| <b>13312</b> CASSETTA CON INOX 60x50x25  | <b>FRR</b>             | P/C.1 |

### Sportelli Per Contatori Inox



Costruzione in lamiera saldata, spessore 7/10", con guarnizione di tenuta.  
Completa di serratura con chiave.

- |   |                        |       |
|---|------------------------|-------|
| <b>58169</b> CASS CONT ZIN STAGNA 40x60 | <b>FRR</b> Art. 040341 | P/C.1 |
|---|------------------------|-------|

### Sportelli zincati per contatori



Spessore lamiera 7/10"  
Completo di serratura con chiave

- |  |                        |       |
|--|------------------------|-------|
| <b>13301</b> SPORTELLO CONT ZINC 40x50 | <b>FRR</b> Art. 040317 | P/C.1 |
| <b>13302</b> SPORTELLO CONT ZINC 45x60 | <b>FRR</b>             | P/C.1 |
| <b>13316</b> SPORTELLO CONT ZINC 66X50 | <b>FRR</b>             | P/C.1 |



**SPORTELLO STAGNO**  
Zincato.  
Dimensioni: 40 x 35 cm

- |                                     |                         |       |
|-------------------------------------|-------------------------|-------|
| <b>58170</b> SPORTELLO STAGNO 40x35 | <b>FRR</b> Art. 0000ART | P/C.1 |
|-------------------------------------|-------------------------|-------|



Spessori:  
• acciaio inox: 7/10"  
Completo di serratura con chiave.

- |  |                        |       |
|--|------------------------|-------|
| <b>13300</b> SPORTELLO CONT INOX 30x40 | <b>FRR</b> Art. 040322 | P/C.1 |
| <b>13311</b> SPORTELLO CONT INOX 40x50 | <b>FRR</b> Art. 040315 | P/C.1 |

### Cassette Per Contatori Rame



**CASSETTA PER CONTATORE**  
In rame.  
Dimensioni: 50 x 40 x 25 cm

- |                                      |            |       |
|--------------------------------------|------------|-------|
| <b>58171</b> CASS CONT RAME 50x40x25 | <b>FRR</b> | P/C.1 |
| <b>58172</b> CASS CONT RAME 40x30x25 | <b>FRR</b> | P/C.1 |

### Accessori Per Cassette Contatori

Costruzione in lamiera saldata spessore 7/10  
AI» mimo e Ridiede

- |   |                          |       |
|---|--------------------------|-------|
| <b>13313</b> SCHIENALE x CASS ZIN 40x50 | <b>FRR</b> Art. 040318/2 | P/C.1 |
| <b>13314</b> SCHIENALE x CASS ZIN 45x60 | <b>FRR</b> Art. 040318/3 | P/C.1 |



- |   |                        |       |
|---|------------------------|-------|
| <b>13315</b> CHIAVE x CASSETTA CONTATOR | <b>FRR</b> Art. 040309 | P/C.1 |
|---|------------------------|-------|

**Vaschette Per Abbeveratoi**

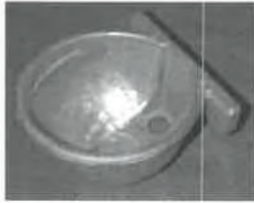

**Realizzata in smalto porcellanato inorganico per zootecnia. Verniciata nera. Monta la valvola Cod. 50205**

**50001 VASCHETTA NILO** BAS P/C.1



**50101 VASCHETTA TUBO VERTICALE** FOR Art. P 20 P/C.1



**50102 VASCHETTA MURO VERTICALE** FOR Art. P 21 P/C.1



**50103 VASCHETTA TUBO ORIZZONTALE** FOR Art. P 22 P/C.1



**50104 VASCHETTA MURO ORIZZONTALE** FOR M. P 23 P/C.1

**Valvole Per Vaschette Abbeveratoi**



**Valvola adatta per vaschetta Nilo**

**50205 VALVOLA ABBEV AT INF 1x1/2** BAS Art. 109 P/C.1

**Pezzi Di Ricambio Per Valvole Abbeveratoi**



- 50207 NILO PISTONC P/VALV C/GUAR** BAS P/C.1
- 50209 NILO VITI REGISTRO** BAS P/C.1
- 50210 NILO MOLLE** BAS P/C.1
- 50211 NILO CODULI C/GIREL 1x1/2** BAS P/C.1
- 50212 NILO CODULI C/GIREL 1x3/4** Bas P/C.1
- 50214 NILO CROCIERE** BAS P/C.1
- 50215 NILO GUARNIZIONI PARA PICC** Bas P/C.100
- 50216 NILO GUARNIZIONI PARA GRAN** BAS P/C.100
- 50217 NILO GUARNIZIONI FIBRA 3/4 L-G** Art. 3FS03418 P/C.100
- 50218 NILO GUARNIZIONI FIBRA 1** L-G Art. 3FS00118 P/C.100



**50301 PALETTA P20-21-22-23** FOR Art. 1 P/C.1



**50302 SPRUZZO P20-21-22-23** FOR Art. 2 P/C.1



**50303 TAPPO IN GOMMA PIATTO** FOR Art. 3 P/C.1



**50304 BUSSOLA CON TAPPO X P 20** FOR Art. 4 P/C.1



**50306 CROSETTA PER P20-21-22-23** FOR Art. 6 P/C.1



**50307 MOLLA PER P20-21-22-23** FOR Art. 7 P/C.1



**50308 DADO REGISTRO PER P20** FOR Art. 8 P/C.1



**50309 REGISTRO PER P20-21-22-23** FOR Art. 9 P/C.1



**50310 ASTINA PER P20-21-22-23** FOR Art. 10 P/C.1



**50312 DADO ASTINA P20-21-22-23** FOR Art. 12 P/C.1



**50320 GUARNIZIONE IN GOMMA** FOR Art. T.N. P.20 P/C.100

### Pompe Elephas A Meno



	OLINEMO	HW	MIUZIA	POMM	ILOCLO	umtn	Ra0
1	55	1"	25	515	0.530	15	4
2	60	1 1/8"	30	540	0.480	21	11.5
3	70	1 1/2"	32	580	0.670	26	12.5
4	80	1 3/4"	35	620	0.780	31	14.5

**52320 POMPA ELEPHAS VERDE 1** GMP Art. 1138 P/C.1

**52321 POMPA ELEPHAS VERDE 2** GMP Art. 1139 P/C.1

**52322 POMPA ELEPHAS VERDE 3** GMP Art. 1140 P/C.1

**52323 POMPA ELEPHAS VERDE 4** GMP Art. 1141 PIC.1

### Ricambi Per Pompe Elephas



**52301 PISTONE ELEPHAS 1** GMP Art. 6000 P/C.10

**52302 PISTONE ELEPHAS 2** GMP Art. 6001 P/C.10

**52303 PISTONE ELEPHAS 3** GMP Art. 6002 P/C.10

**52304 PISTONE ELEPHAS 4** GMP Art. 6003 P/C.10



**52306 CALOTTA CUIOIO x ELEPHAS 1** GMP Art. 6086 P/C.10

**52307 CALOTTA CUIOIO x ELEPHAS 2** GMP Art. 6087 P/C.10

**52308 CALOTTA CUIOIO x ELEPHAS 3** GMP Art. 6088 P/C.10

**52309 CALOTTA CUIOIO x ELEPHAS 4** GMP Art. 6089 P/C.10



**52310 BIELLA x ELEPHAS 2** GMP Art. 5890 P/C.1



**52312 PLANCIA x ELEPHAS 2 - 3** GMP Art. 5938 P/C.1



**52316 VALVOLA INFERIORE N 1** GMP Art. 6022 P/C.10

**52313 VALVOLA INFERIORE N 2 § 77** GMP Art. 6023 P/C.10

**52314 VALVOLA INFERIORE N 3 § 84** GMP m. 6024 P/C.10

**52315 VALVOLA INFERIORE N 4 § 90** GMP Art. 6025 P/C.10





# Irrigazione



**22945 BANDIERINA PICCHETTO 6805** SRI Art. 1.51001.11 P/C.1



Slitta zincata  
in metallo  
fil 1/2" F  
e 3/4" F  
con innesto.

**75971 SLITTA x IRRIGAT ATTAC 1/2** IPR Art. 2803 P/C.1



ZINCATI  
ZAMPE REGOLABILI  
Filetto: da M 3/4 a M 1,1/4

**22381 SUPPORTO x IRRIG FIL 3/4** M-M Art. TR 3/4 P/C.1

**22382 SUPPORTO x IRRIG FIL 1** M-M Art. TR 1 P/C.1

**22383 SUPPORTO x IRRIG FIL 1.1/4** M-M Art. IR 1.1/4 P/C.1



Irrigatore a settore  
e circolare  
con attacco f1 1/2" M.  
Ugello standard 0 4,5 mm.  
Press. min/max: 1,5 / 3,5 atm.  
Gittata min/max: 11,5 / 13,5 m  
Portata min/max: 0,22 / 0,31 lt/sec

**75975 BETA GARDEN IRRIG M 1/2** IPR Art. 2065 P/C.1



Irrigatore a settore  
e circolare  
con attacco fil 3/4" E  
Ugello standard 0 5 mm.  
Press. min/max: 1,5 / 3,5 atm.  
Gittata min/max: 12,5 / 15 m  
Portata min/max: 0,31 / 0,48 lt/sec

**75950 IRRIGATORE FILET F 3/4** IPR Art. 2624 P/C.1

**75960 UGELLO x IRRIGAT 2624 § 4** IPR Art. 2623/4/4 P/C.1

**75961 UGELLO x IRRIGAT 2624 § 4.5** IPR Art. 2623/4/4.5 P/C.1

**75962 UGELLO x IRRIGAT 2624 § 5.5** IPR Art. 2623/4/5.5 P/C.1



Irrigatore a settore  
e circolare  
con attacco f1 1/2" E  
Ugello standard 0 6 mm.  
Press. min/max: 2 / 5 atm.  
Gittata min/max: 14 / 18 m  
Portata min/max: 0,52 / 0,82 lt/sec

**75953 IRRIGATORE FILET F 1** IPR Art. 2626 P/C.1



Irrigatore a settore  
e circolare  
con attacco fil 1,114" E  
Ugello standard 0 10 mm.  
Press. min/max: 1,5 / 14 atm.  
Gittata min/max: 16 / 22,5 m  
Portata min/max: 1,2 / 21 lt/sec.

**75956 IRRIGATORE FILET F 1.1/4** IPR Art. 2628 P/C.1



IRRIGATORE A BATTENTE PER IRRIGAZIONE A  
SETTORI O A GIRO COMPLETO MONTATO SU  
STABILE PICCHETTO A DOPPIO PUNTALE  
DISPOSITIVO DI AUTOREGOLAZIONE PER  
PRESTAZIONI OTTIMALI



**249 m<sup>2</sup>**

CONF	CLTA	CM. MIS.	W VOL	KG	TA
5	28-25.13	0.009	1.75	360	

**23690 IRRIGATORE IMPACT PICCHET.** CLR Art. 88100000 P/C.1

## IRRIGATORI DINAMICI

MODELLO	6702		osa		1117.11	
	Bars	lt/min. rag. m	lt/min. rag. m	lt/min. rag. m	lt/min. rag. m	
2,10	7,20	11,00	10,80	11,50	13,70	12,15
2,45	7,80	11,50	11,40	12,00	15,20	12,45
2,80	8,40	11,50	12,60	12,00	16,40	12,75
3,15	8,40	11,50	13,20	12,50	17,10	12,80
3,50	9,09	11,50	13,80	12,50	18,30	12,85
3,85	9,80	11,50	14,40	12,50	19,00	12,90



- Li A settori e giro completo (30' - 3609
- Irrigatore di Colcon e Lexan
- Cassa e coperchio in polipropilene
- Vite rompigitto
- Braccio antispruzzo
- Guarnizioni antisabbia
- Molle in acciaio inossidabile
- Filtro di protezione
- Sollevamento pistone mm 75
- Dimensioni altezza mm 230 - diametro mm 145
- Attacco laterale o inferiore 0 1/2 " F

**22915 IRRIG.PERC.30-360° NELSON** SRI Art. 1.38003.11 P/C.1

**\*PIERRE**  
garden  
PERIRE SIROTEX S p A

### Irrigatori Turbina Completi Di Boccagli Hunter



Numero bocaglio	Pressione Bare	Raggio m	Portata lt./min.
<b>.75</b>	2,1	5,2	2,4
	2,8	5,5	2,8
	3,4	5,5	3,2
<b>1.0</b>	2,1	6,1	3,2
	2,8	6,4	3,8
<b>1.5</b>	3,4	6,4	4,2
	2,1	7,0	4,9
<b>2.0</b>	2,8	7,3	5,7
	3,4	7,3	6,4
<b>2.0</b>	2,1	7,6	6,4
	2,8	8,2	7,6
<b>3.0</b>	3,4	8,2	8,7
	2,1	8,5	9,5
<b>3.0</b>	2,8	9,1	11,4
	3,4	9,1	12,9

MODELLO	installazione	Angolo di	Soheya-mento pistone	Dimensioni Corpo	Attecc
		di		mm	
<b>PGNI-04</b>	sottosuolo	cyclolac da 40' a 360'	100	170 x 30	1/2" F
<b>PGM-06</b>	sottosuolo	cyclolac da 40' a 360"	150	220 x 30	1/2" F

**22938 IRRIGATORE TURBINA PGM-04** SRI Art. 1.40001.11 P/C.1

**22918 IRRIGATORE TURBINA PGM-06** SRI Art. 1.40003.11 P/C.1



Numero hpe46500	PPeesime	Reggio m	Panata (t/min.	Numero ~caglio	Pressione Bere	5959i° .1	Prtaxa lt. min.
<b>1</b>	2,1	8,5	1,9	<b>7</b>	2,1	11,0	9,8
	2,8	8,8	2,3		2,8	12,2	11,4
	3,4	8,8	2,7		3,4	12,8	11,7
<b>2</b>	4,1	9,1	3,0	<b>10</b>	4,1	12,8	12,1
	2,1	8,8	2,6		2,1	11,3	12,1
	2,8	9,1	3,0		2,8	12,2	14,0
<b>3</b>	3,4	9,1	3,4	<b>11</b>	3,4	13,1	15,9
	4,1	9,4	3,4		4,1	13,4	17,4
	2,1	9,1	3,4		2,1	11,8	15,9
<b>4</b>	2,8	9,4	3,8	<b>12</b>	2,8	13,1	18,5
	3,4	9,4	4,5		3,4	14,0	n .8
	4,1	9,8	4,9		4,1	14,3	22,7
<b>5</b>	2,1	9,8	4,5	<b>11</b>	2,8	13,7	22,7
	2,8	10,1	4,5		3,4	14,6	25,7
	3,4	10,4	4,5		4,1	14,9	Ma
<b>6</b>	4,1	19,4	6,8	<b>11</b>	4,8	15,5	31,0
	2,1	10,4	8,1		2,8	14,0	30,3
	2,8	11,0	8,1		3,4	14,6	33,7
<b>6</b>	3,4	11,6	7,6	<b>12</b>	4,1	15,2	37,1
	4,1	11,6	8,3		4,8	15,5	39,7
	2,1	11,0	7,6		2,8	14,9	43,2
<b>6</b>	2,8	11,6	9,1	<b>12</b>	3,4	14,4	46,2
	3,4	12,2	10,2		4,1	15,2	60,8
	4,1	12,2	11,0		4,8	15,9	54,5

MODELLO	Installazione	Angolo di lavoro	Sollevamento pistone	Dimensioni Corpo	Attecc
			mm	mm	
<b>PGP-ADJ</b>	sottosuolo	da 40' a 360	100	180 x 70	3/4" F

**22935 IRRIGATORE TURB. PGP-ADJ** SRI Art. 1.40005.11 P/C.1

### IRRIGATORI STATICI irrigatori Statici Srs Senza Testine Hunter

## II SERIE SRS HUNTER

**22917 IRRIGAT STAT SRS-06 H 150** SRI Art. 1.36009.11 P/C.25

#### Caratteristiche:

- Ampio filtro di protezione.
- Superficie esposta mm 50.
- Frizione sul pistone di sollevamento.
- Guarnizione ontisabbia resistente ai raggi UV.

**22939 IRRIG STAT SRS-04 H100 HUN** SRI Art. 1.36008.11 P/C.25

**22916 IRRIGAT STAT SRS-02 H 50** SRI Art. 1.36006.11 P/C.1

#### Tostino Standard Per Statici m 45

### STANDARD

MODELLO	Piapple di lavoro	h11roa	Pc...t.	Raro
<b>N 15-F</b>	380°	1,40	11,4	3,6
		1,75	12,5	4,2
		2,10	14,0	4,5
<b>N 15-TO</b>	270°	1,40	8,7	3,8
		1,75	9,5	4,2
		2,10	10,6	4,6
<b>N 15-77</b>	240°	1,40	7,6	3,6
		1,75	8,3	4,2
		2,10	9,5	4,5
<b>N 1541</b>	180°	1,40	5,7	3,6
		1,75	8,5	4,2
		2,10	7,2	4,5
<b>N 15-T</b>	120°	1,40	3,8	3,0
		1,79	4,2	4,2
		2,10	4,8	4,5
<b>1415-O</b>	90°	1,40	3,0	3,6
		1,75	3,0	4,2
		2,10	3,4	4,5



**22941 TESTINA STAND N15-F 360°** SRI Art. 1.41104.11 P/C.25

**22942 TESTINA STAND N15-TQ 270°** SRI Art. 1.41105.11 P/C.25

**22943 TESTINA STAND N15-H 180°** SRI Art. 1.41108.11 P/C.25

**22944 TESTINA STAND N15-Q 90°** SRI Art. 1.41110.11 P/C.25

Testine Standard Per Statici quadrato e fascia

## STANDARD

MODELLO	Angolo di lavoro	Press. Bara	Portate It./min.	Lati
N 15-SO	quadrato	1,40	11,4	6,1 x 6,1
		1,75	12,5	6,7 x 6,7
		2,10	14,0	7,3 x 7,3
		1,40	3,8	1,2 x 8,5
N 15-SST	laterale	1,75	4,2	1,2 x 8,5
		2,10	4,6	1,2 x 9,1
		1,40	1,9	1,2 x 4,2
N 15-EST	striscia esterna	1,75	2,3	1,2 x 4,2
		2,10	2,3	1,2 x 4,5
		1,40	3,8	1,2 x 8,5
N 15-CST	centro striscia	1,75	4,2	1,2 x 8,5
		2,10	4,6	1,2 x 9,1

22946	TESTINA STAND N15-SQ QUADR	SRI Art. 1.41111.11	P/C.25
22947	TESTINA STAND N15-SST LATE	SRI Art. 1.41112.11	P/C.25
22948	TESTINA STAND N15-EST TERM	SRI Art. 1.41113.11	P/C.25
22949	TESTINA STAND N15-CST C/ST	SRI Art. 1.41114.11	P/C.25

Testine Striscia Per Srs Hunter

### TESTINE A BANDA RETTANGOLARE

MODELLO	Press. Bara	Portate It./min.	Lati
LCS-515	1,35	5x1,6	2,3
	2,10	1,5 x 4,6	2,5
	2,40	1,5 x 4,6	2,6
ORCS-515	1,75	1,5x 4,6	2,3
	2,10	1,5 4,6	2,5
	2,40	1,5 4,6	2,6
55-530	1,75	1,5 x 9,1	4,5
	2,10	1,5 x 9,1	4,9
	2,40	1,5 x 9,1	5,3

22900	TESTINA PL. LCS-515	SRI Art. 1.41091.11	P/C.25
22901	TESTINA PL. RCS-515	SRI Art. 1.41092.11	P/C.25
22902	TESTINA PL. SS-530	SRI Art. 1.41093.11	P/C.25

Testine Standard Per Statici raggio m 3 traiettoria 15°

## SOTTOSTANDARD

### TESTINE PLASTICA SERIE N 10 LA - TRAIETTORIA 15°

MODELLO	Angolo di lavoro	Press. Bara	Portate It./min.	Raggio in
N 10 LA-F	360°	1,75	5,3	2,44
		2,10	6,0	2,74
		1,40	2,7	3,05
N 10 LA-H	180°	1,75	3,0	2,44
		2,10	3,0	2,74
		1,40	1,1	3,05
N 10 LA-O	90°	1,75	1,5	2,44
		2,10	1,5	2,74
		1,40	1,5	3,05

22982	TESTINA PL NIOLA-H A 180°	SRI Art. 1.41122.11	P/C.25
22983	TESTINA PL NIOLA-F A 360°	SRI Art. 1.41121.11	P/C.25
22984	TESTINA PL NIOLA-Q A 90°	SRI Art. 1.41123.11	P/C.25

Testine Standard Per Statici raggio m 3 traiettoria 5°

### TESTINE PLASTICA SERIE N 8 FLT - TRAIETTORIA 5°

MODELLO	Angolo di lavoro	Press. Bara	Portate It./min.	Raggio m
N 8 FLT-F	360°	1,40	4,5	2,44
		1,75	5,3	2,74
		2,10	6,0	3,05
N 8 FLT-H	180°	1,40	2,7	2,44
		1,75	3,0	2,74
		2,10	3,0	3,05
N 8 FLT-G	90°	1,40	1,1	2,44
		1,75	1,5	2,74
		2,10	1,5	3,05

22936	TESTINA PL N8FLT-Q 90°	SRI Art. 1.41127.11	P/C.25
22937	TESTINA PL N8FLT-H 180°	SRI Art. 1.41126.11	P/C.25

Testine Standard Per Statici raggio m 3,6 traiettoria 30°

MODELLO	Press. Bara	Portate It./min.	Raggio m
N 15-F	360	10	3 6 11 4
	•	42	5
	2 in	14	14
N 15-TQ	270	40	36 8 1
	•	14	4 2 95
		710	45 1a6
N 15-TT	240	1	40 3 6 %
	1,5	42	83
	210	45	95
N 15-H	180	1	40 36
		17	5
	710	4	17
N 15-T	120	1	36 38
		4,2	17
	210	4,5	46
N 15-Q	90	1	13 17 3,0
	•	/s	12 31J
	10	t	34

22967	TESTINA PL.N12-I <sup>7</sup> 360°	SRI Art. 1.41115.11	P/C.25
22961	TESTIN SOTTOST N12-TQ 270°	SRI Art. 1.41116.11	P/C.25
22962	TESTIN SOTTOST N12-H 180°	SRI Art. 1.41118.11	P/C.25
22934	TESTIN SOTTOS PL N12T 120°	SRI Art. 1.41119.11	P/C.25
22963	TESTIN SOTTOST N12-Q 90°	SRI Art. 1.41120.11	P/C.25

Testine Regolabili da 25° a 360° per statici

Prestazioni Serie 1°5"	90	120°	180	270	360°
			G	C7	O
IMMO	rzt.				
TRAIETTORIA 28	1,75	5,2	6,8	5,2	6,3
© 17A	2,00	5,4	7,1	5,4	7,8
Bianco	2,50	5,6	8,0	5,6	8,8
TRAIETTORIA 28	1,75	4,6	3,4	4,6	4,2
O 15A	2,00	4,8	3,7	4,8	4,5
Moro	2,50	5,0	4,3	5,0	5,1
TRAIETTORIA 28"	1,75	3,7	3,1	3,7	3,4
e 12A	2,00	4,1	3,3	4,1	3,7
Verde	2,50	4,3	3,5	4,3	4,3
TRAIETTORIA 15	1,75	3,1	1,5	3,1	3,1
O 10A	2,00	3,3	1,8	3,3	2,3
Sono	2,50	3,4	1,9	3,4	2,6

- 22903 TESTINA PL S-10A 25-360°** SRI Art. 1.41081.11 P/C.25  
**22959 TESTINA PL S-12A 25-360°** SRI Art. 1.41084.11 P/C.25  
**22958 TESTINA PL S. 17A 25-360°** SRI Art. 1.41087.11 P/C.25

### Prolunghes Per Irrigatori

Ippli-prolunga in polipropilene a più stadi che si pongono al di sotto degli irrigatori a scomparsa. In funzione della profondità di scavo, si possono tagliare uno o più segmenti.

- 22927 PROLUNGA SEG AT I/2Mx1/2M** SRI Art. 1.47003.11 P/C.50  
**22928 PROLUNGA SEG AT 3/4Mx3/4M** SRI Art. 1.47004.11 P/C.25  
**22929 PROLUNGA SEG AT 3/4Mx1/2M** SRI Art. 1.47005.11 P/C.40

La prolunga regolabile Mod. SH 22, viene utilizzata nella fase di collocamento di irrigatori a scomparsa. Permette anche successivamente al termine dell'installazione, l'esatto posizionamento degli irrigatori in funzione dell'assetamento del terreno.

#### Particolari:

- Attacco superiore da 1/2" e 3/4" M.
- Attacco inferiore da 3/4" M.
- Altezza totale max cm. 20.

- 22964 PROLUNGA TELESCOPICA SH-22** SRI Art. 1.47001.11 P/C.1



Completa di adattatore per utilizzo di testine con filetto maschio da 1/2" Altezza variabile da 40 a 80 cm.

- 22422 PROLUNGA TELESCOPICA 1/2** UNI Art. 82399 P/C.1

### Elettrovalvole



Valvole studiate per l'impiego in piccoli, medi, grandi impianti residenziali e per l'automazione degli impianti pubblici sportivi ed agricoli dove è richiesto un prodotto della massima affidabilità. Con comando manuale e regolatore di flusso.

- 22910 ELETTROVALV FF REG/FLU 3/4** SRI Art. 1.42007.33 P/C.1

- 22911 ELETTROVALV FP REG/FLUS. 1** SRI Art. 1.42008.33 P/C.1  
**22906 ELETTROVALVFF REG/F 1.1/2** SRI Art. 1.42010.33 P/C.1  
**22913 ELETTROVALV FF 1.1/4** SRI Art. 1.42009.33 P/C.1



e elettrovalvole della Serie 21-000 'n linea, semplici ed economiche sono state studiate appositamente per l'impiego in piccoli impianti d'irrigazione di terrazze, serre e vivai. l'apertura manuale della valvola, permette lo scarico dell'acqua al suo interno, evitando fastidiose perdite all'esterno. La valvola può essere aperta o chiusa anche in assenza di corrente svitando e avvitando a scatti il solenoide.

MODELLO	Armo	Altezza	Losik	fagli.
			●●	Eant
<b>21-250</b>	<b>3/4" M</b>	117	111	<b>62</b>
<b>21-320</b>	<b>1" M</b>	127	127	<b>62</b>

- 22907 ELETTROVALV MM21-250 3/4** SRI Art. 1.42030.33 P/C.1  
**22912 ELETTROVALV MM 21-320M I** SRI Art. 1.42031.33 P/C.1



Connettere pre-riempito per cavi elettrici a tenuta stagna. Semplici e rapidi da installare consentono il collegamento stagno di due o tre cavi elettrici a bassa tensione (24 Vac). Sono quindi indispensabili per il collegamento delle elettrovalvole ed offrono un ottimo isolamento anche in pozzetti allagati.

Caratteristiche:

- II Temperatura di funzionamento: — 30 a +105° C.
- Tensione/massimo 30 Volts.
- Adatto per cavi di sezione da 0,5 a 1,5

- 22996 CONVETTORE CAVI/E T/STAGNA** SRI Art. 1.51040.01 P/C.1

### Elettrovalvole programmabili



A . . A13550 CONSA40 E . . NZIAA  
 . . SA 8ATIIR;A DA MI I . . 1 5  
 RA S T AG ChI. r 5511  
 S1 PARAILLE CA ; RA rO, i Ah  
 . . t .  
 • DURAME L t ii 5578C PRESSICV ES14; 30 JA  
 . . : SAI I' I V ITA'A • I • CTA  
 • FIMIA NA F • q AIA 'i 4 •  
 " . . f

SCA,

- 23882 ELETTROV.PROGRAMMAB FF I** CLR Art. 90900009 P/C.1



CONF	Q.TA	CM 1415	M' VOL	KG	Q TA
	1	18.18-12	0.004	0.95	144

**23883** ELETTROV.PROGRAMMAB MM 3/4 CLR Art. 90901000 P/C.1

### ACCESSORI

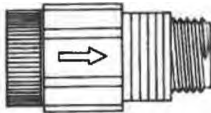

#### Particolari:

- Portata da 0 a 30 it./min.
- Pressione uscita 1,75 Bars.
- Attacco 0 3/4" F x 3/4" M.

**22940** REGOLATORE PRESS PRE-TARAT SRI Art. 1.53402.88 P/C.1

### Collettore



**22920** TEE CON DUE BOCCHETTE 77° 1 SRI Art. 1.05032.33TP/C.20



**22921** GOMITO CON BOCCHETTONI SRI Art. 1.05032.33G P/C.20



**22922** BOCCHETTE 3/4 SRI Art. 1.19025.33 P/C.20

PN 16

**22923** NIPPLO x DUE COLLETT MF 1 SRI Art 1.05032.33D P/C.20

### Valvole Di Drenaggio



#### Valvola di Drenaggio.

Indispensabile per scaricare l'acqua dalla linea ed evitare il congelamento.  
In cartella blister.

**22407** VALVOLA DI DRENAGGIO 1/2 SRI Art. 1.51007.22 P/C.25

**22409** VALVOLA DI DRENAGGIO 3/4 SRI Art. 1.51007.11.1 P/C.20



**22970** FILTRO LINEA IN POLIET I SRI Art. 1.53202.11 P/C.1

**22971** FILTRO LINEA A Y 1.1/4 SRI Art. 1.53203.11 P/C.1

**22972** FILTRO LINEA A Y 1.1/2 SRI Art. 1.53204.11 P/C.1

**22973** RICAMBIO x FILTRO 3032 SRI Art. 1.52071.11 P/C.1



**39821** IDRANTINO M 3/4 FIV Art. P3039007 P/C.5

**39825** COPERCHIO x IDRANTINO GIRL FIV P/C.10



**39822** CHIAVE x IDRANTINO FIV Art. P3139007 P/C.5



O	A	Pak
16 - 49	5	250
40 ÷ 75		75
63 ÷ 125		40

**39826** CHIAVE FISSA x RACC 16/40 FIV Art. P7990016040 P/C.1

**39827** CHIAVE FISSA x RACC 40/75 FIV Art. P7990040075 P/C.1

**39828** CHIAVE FISSA x RACC 63/125 FP/ Art. P7990063125 P/C.1

### Pozzetti



Nese cs	Coperchio tre	Altezza con	Corpo
0 20	0 18	23	1 rotondo

**22440** POZZETTO § 18 X H23 TONDO SRI Art 1.45001.11 P/C.5

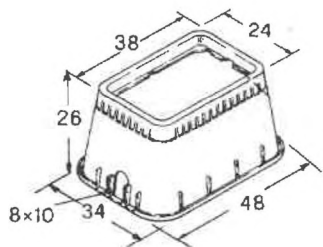

**D 1000**

**22442 POZZETTO 34x48 BASE RETTAN** SRI Art. 1.45005.11 P/C.2

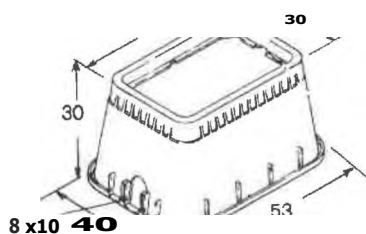

**D 1200**

**22931 POZZETTO 40x53 BASE RETTAN** SRI Art. 1.45002.11 P/C.1

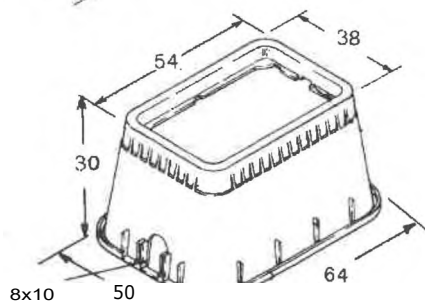
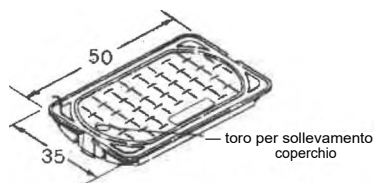

**D 1500**

**22933 POZZETTO 50x64 BASE RETTAN** SRI Art. 1.45006.11 P/C.1

**Centralino**



**Centralina AQUAPROGRAM**  
 Display di uso facile e intuitivo.  
 72 programmi diversi.  
 Durata selezionabile da 1 a 90 min.  
 Regolazione giornaliera e settimanale.  
 Utilizzabile con rubinetti da r e da 3/4".  
 Garanzia 12 mesi.  
 Imballo: 3 pezzi.

**22403 CENTRALINA AQUAPROGRAM** UNI Art. 66100 P/C.6



**Particolari:**

- DaDIDIo programma**
- Massimo otto partenze giornaliere, minimo una partenza ogni ventotto giorni per stazione.

**22904 CENTR.DP 2 STAZIONI ELETTR** SRI Art. 1.44012.01 P/C.1

**22905 CENTR.DP 6 STAZIONI ELETTR** SRI Art. 1.44013.01 P/C.1

**Caratteristiche:**

- Tempi di irrigazione da 2, 5, 10, 15, 20, 25, 30, 45, 60, 120 minuti.
- Due programmi A, B.
- Ogni Orazione può essere assegnata ad uno o a tutti e due i programmi disponibili (ABI).
- Quattro partenze giornaliere per programma.
- Calendario bisettimanale con scelta dei giorni della settimana, giorni pari o dispari, o con intervalli da 1 a 28 giorni.
- Ciclo test di due minuti per ciascuna stazione.
- Tasto RANA DELAY per ritardare o interrompere il ciclo irriguo da 24 a 72 ore.
- Programma soccorso.

**CON TRASFORMATORE INCORPORATO**

**22987 CENTRAL. 4 STAZIONI IBRIDA** SRI Art. 1.44020.01 P/C.1

**22988 CENTRAL. 6 STAZIONI IBRIDA** SRI Art. 1.44021.01 P/C.1

**22989 CENTRAL. 8 STAZIONI IBRIDA** SRI Ad. 1.44022.01 P/C.1

**22991 CENTRAL.12 STAZIONI IBRIDA** SRI Art. 1.44029.01 P/C.1





CONF	Q TA	CM MIS	M VOL	KG	PRELLO VI
1		24.26-8	0.005	1.25	108

MANDA "SIA. 51" di LvAtt Cl.a...EGAVEN\*G  
**INNESTO DEI FILI ELETTRICI** **Nuovi**,  
 CONCEZIONE COPERCHIO TRASPARENTI PER UNA  
 FACILE LETTURA DEI DAT, IMPOSTATI ESCLUSI".  
 MANOPOLA ROTATIVA PER LA SELEZIONE O.  
 PROGRAMMI. SISTEMA A LED LUMINOSI CECA  
 CONTROL PER IL MONITORAGGIO FUNZIONI DEL  
 PROGRAMMATORE. PROGRAMMAZIONE FACILITA' A  
 PROGRAMMI PRE IMPOSTATI DURATA  
 RIRIGAPONE DAL M1N A 2 ORE PARTENZA  
 PROGRAMMI A INTERVALLI PREFISSATI 4.6H  
 AGGSOG VASTO STARE PER PAR'E':A  
 naGkAMMi IMMEDIATA TASTO RAiry.STOP aER  
 INTERRUZIONE PROGRAMMI .2415) CASA i.  
 OGGIA PROGRAMMAZIONE MANUALE REI\*  
 (POSTAZIONE PERSONALIZZATA DEI TEMPI DI  
 REGIAZIONE SU CIASCUNA LINEA DISPOSITIVO DI  
 PREZZA APERTURA VALVOLE CON RITARDO D t.  
 SECONDI COMANDO POMPA BATTERIA TAMPONE  
 9 4 TRASFORMATORE ESTERNO INCLUSO  
 PETTA LE NORMAT•T C



**23790 PROGRAMM METEOCRITERIUM 6** CLR Art. 8013000 P/C.1



**IO 40 to get,**

Tensione primaria: 220/240VAC/50Hz  
 o I IOVAC/60Hz  
 Tensione secondaria: 0-12-24V 50Hz  
 Trasformatore: 30VA  
 Protezione termica  
 Numero massimo linee attivabili:  
 3 +Valvola Principale  
 Certificato CE



R.11 TURISTit ii

- Programmy .0Fi nsier
- Programmoome mddacodente p..
- Nogr.nlnuazione m cr.ro.ti o nbrut.ecennt
- Programmadone aecha di 31 rom .onstertà  
giorno 4 parecou
- Moduod. programmoone essraitse a morse Mera m  
una scemia sheudibie con serranda r cOove
- Programma mserno d1 siisa .n1S0 9.1d mm.
- I I programm possono essere .11 040) su una nomina
- Pitgr:rdsoarione con +0010 e \*croce
- Trasroimazore sommo
- snesno M canoa Nasone muoio
- sProgramosa"v.\*" programmabie da I secondo
- 5 num\* c 59 UMMull per buss
- Rmardo prog. - tra rnaadura e srproM\*ra es
- PesoIMst melflOssit M9ada von Imnspte O .1  
mmoro pompa per ogni programma
- Censore indmenden per programma
- 4 fmgue\*Psglese Francese **SOI**:  
Virlit .C d'ente 3mrtaton tin 0% i 150 mm  
IM'emern o decrement, osi le.  
I 0,1 - F n,01130,50nm, A Tua r mo
- Ada . a spni medi porch. p.1111 -
- Peerut,oaeco wernlc
- Ad., p\*\* rignl011.er e :y-p12,we Cr eu
- la W., m frof. sniugglo:
- Se.ph. q' on.angevie nilmlicoran: e.L. 410,1010
- ...pa .2mmsCC 1.0 di once, e . le rorr  
o'tenwip...
- Mer\*..razzindr de, \*mrann.. orrrndt
- P'**, .....
- mago ad mune 4111.1200 5. ror
- {Frodo Momoserd oIP\*oblem
- Oto.
- Ripom o d'urqua
- Adollo nrrr0 Mennilmon\*
- 5. arze0 Kfrauco
- 9.0 essertArgam dnaldsdo Tipo di .T..
- 5.117.0 id-OaiM0
- Cmoode 0010., 0+0.or0mce, 0010.0110,0
- (50 merro)ondie
- 1W.. ap otomem, 0nponoli
- L.,14 vene h :01,400 \*.:47100

**23793 PROGRAMM METEOLAB 9** CLR Art. 8041000 P/C.1

**IMPIANTI GOCCIA A GOCCIA**



130 IN POLTE FILENL 19k i.? 3 I b MM.; PER 1,;  
 NEA PR:NCIPALE FLESSIBILE ANTIAGIHE  
 ALLE BASSE TEMPERATURE E. AI RAGO  
 z"TOI n r);,

CONF	Q TA	CM MIS	M VOL	KG	PRELLO VI
ROT.	1	0 44x15	0.023	3.07	24

**23779 TUBO COLLETTORE M 50 I/2** CLR Art. 90366000 P/C.1



**JBO DA :4' 14-6 MM** DERIVAZ'ONS • A  
 TUBO COLLETTORE. ALIMENTA + GOCCIOIATOR! IN  
 LINEA E EINE LINEA. FLESSIBILE, A ". TIALGHE,  
 RESISTE ALLE BASSE TEMPERATURE L AI RAGGI  
 DE. SOLE. ROTOLO DA 20 M.

CONF	Q TA	CM frirà	M'VOL.	KG	TA
		<b>8.25-19</b>	<b>0.013</b>	<b>1.81</b>	<b>240</b>

**23777 TUBO CAPILLARE M20 1/4** CLR Art. 90370000 P/C.1





IDEALE PER FISSARE STABILMENTE TUBO CAPILLARE DA 14.6 MM) NEL TERRENO DEL GIARDINO O NELLA TERRA DEI VASI IN TERRAIO, BLISTER DA PZ.

CONF	Q.TA	CM MIS.	M'VOL.	KG	hiffia TA
	10	28-25-19	0,013	1,0	480

23823 FITTONCINI X CAPILL.1/4 CLR Art. 91190000 P/C.1



**AA** icrotubo spaghetto in gomma di alta qualità e Flessibilità, utilizzato per collegare gocciolatori e microspray alla tubazione principale.

22955 MICROTUBO 4 x 7 mm STV470 SRI Art. 1.00060.11 MT/C.220



MODELLO **RSP4** Innesto diritto Confezione **4 mm .500**

22954 INNESTO DIRITTO 4 mm RSP4 SRI Art. 1.53047.11 P/C.500

III. 1111. 16-30 passo 30 cm  
16-40 passo 40 cm  
Rotolo 50 mt passo 30 cm



22960 ALA GOCCIOLANTE 16,30N SRI Art. 1.01163.11A M/R,200

75981 ALA GOCCIOLANTE 16-40N SRI M/R,200

75980 ALA GOCCIOLANTE RT 50 m IPR Art. 2487 M/R.50

MODELLO **PA40** 1000 pezzi

**picchetto** utilizzato per ancorare al terreno l'ala gocciolante ed il tubo poroso rispettivamente nei diametri 16 e 20 mm.

22995 PICCHETTO PA40 SRI Art. 1.67044.11 P/C.1



22980 TAPPO FINE LINEA 114A § 16 SRI Art. 1.14016.33A P/C.100

22968 TAPPO FINE LINEA 114A § 20 SRI Art. 1.14020.33A P/C.100



22965 RACCORDO FILM 16x1/2 SRI Art. 1.04016.33A P/C.100

22966 RACCORDO FILM 20x1/2 SRI Art. 1.04020.33A P/C.100



22969 TE 90° DERIV.M 16x3/4x16 SRI Art. 1.06018.33A P/C.100



22974 MANICOTTO P/GOMMA § 16 SRI Art. 1.09016.33A PIC.100

22975 MANICOTTO P/GOMMA § 20 SRI Art. 1.09020.33A P/C.100



22976 TEE P/GOMMA § 16 SRI Art. 1.05016.33A P/C.100

22977 TEE P/GOMMA § 20 SRI Art. 1.05020.33A P/C.100



22978 GOMITO P/GOMMA 90° § 16 SRI Art. 1.11016.33A P/C.100

22979 GOMITO P/GOMMA 90° § 20 SRI Art. 1.11020.33A P/C.100



SERVE A DIRETTAMENTE AL RUBINETTO IL TUBO COLLETTORE DA 1 MM.) E IL TUBO CAPILLARE DA 1/4" (4.6 RUBINETTI CON FILETTO 3/4" (20.27 MM PER

CONF	Q.TA	CH. MIS.	M VOL.	KG
	14	25-19-10	0.005	0.40 2016

23808 RACCORDO PER TUBO 1/2-1/4 CLR Art. 91345000 P/C.1



# NN,

**Portagomma** con filetto da 3/4" per tubo principale da 1/2". Avvitabile direttamente al rubinetto. Fornito in cartella blister da 1 pz.

22450 PORTAGOMx TUBO 1/2 FILS/4 UNI Art. 832101 P/C.10



Q

**Portagomma** con filetto da 3/4" per tubo principale da 1/4". Avvitabile direttamente al rubinetto. Fornito in cartella blister da 1 pz.

22451 PORTAGOMx TUBO 1/4 FIL3/4 UNI Art. R32601 P/C.10



22458 FUSTELLA FORATUBO UNI Art. 831172 P/C 10



Pressione RAGGIO PORTATA		
(Bars)	(m)	(lt./h.)
1,0		0-100
1,5		0-100
2,0		0-100

22957 GOCCIOLAT REGOLAB DRIP-ADJsRi Art. 1.67035.01 P/C.250

**MODELLO** MB4SP360  
%Li ostino

**Mini - Bubbler  
Regolabile**



PRESSIONE PORTATA			360
(Bara)	(lt 11 }	(M)	All,4C TRU
1,0	0-100	0-0,20	
1,5	0-115	0-0,33	
2,0	0-130	0-0,57	

22958 GOCCIOLAT SU ASTINA 360° SRI Art. 1.53323.11 P/C.25

Pressione RAGGIO PORTATA		
(Bars)	(m)	(lt./h.)
1,0		4,0
1,5		5,0
2,0		5,7

22950 GOCCIOLATORE NORMALE RN-4 SRI Art. 1.53321.11 P/C.250



Pressione RAGGIO PORTATA		
(Bars)	(m)	(lt./h.)
1,0		3,6
1,5		4,1
2,0		4,0

22952 GOCCIOLATORE AUTOCOMP RA-4 SRI Ad. 1.53324.11 P/C.250



MODELLO	V.1300	VJ180	V.190
Codice	1.53354.11	1.53355.11	1.53358.11
Vari-Jet Regolabile			

PRESSIONI [Rarsi	PORTATA [litri] i	DIAMETRO (ne	PAGGIO	
			011	iml
1,0	O80	0-6,9	0,2,5	0-2,0
1,5	0,93	0-7,8	0-2,8	0-2,5
2,0	0 118	0-8,0	0,3,2	0,3,2

**Applicazioni:**  
Come il modello sopracitato me non è fornito di picchetto. Dotato di valvola regolazione. Utilizza spaghetti STV 335, prolunga P05, RF 200, RF 300 e adattatore 6201. Attacco filettato 0 4 mm.

22202 MICRONEB.VJ360 ,ç 0-8 M SRI Art. 1.53354.11 P/C.50

22203 MICRONEB.VJ180 RAG.0-3.2 M SRI Art. 1.53355.11 P/C.50

22204 MICRONEB.VJ90 RAG.0-3.2 M SRI Art. 1.53356.11 P/C.50



MODELLO	JSF360	JSH180	JJ3090
Godine	1.63358.11	1.53369.11	1.53380.11

PRESSIONE PORTATA (bars)	PORTATA (lt.41.1	DIAMETRO (rte	RAGGIO	
			(ml	(ml
0,7	25	2,49	1,20	1,80
1,0	36	2,40	1,20	1,80
1,5	11	2,40	1,20	1,80

**Applicazioni:**  
Particolarmente indicato per serre dove viene richiesta una polverizzazione dell'acqua che deve mantenere umidi fiori e piante nelle ore più calde del giorno. Utilizza spaghetti STV 355, prolunga PSS, RF 200, RF 300 e adattatore 6201. Attacco filettato 0 4 mm.

22205 MICRONEB.JSF360 2.4 M SRI Art. 1.53358.11 P/C.100

22206 MICRONEB.JSH180 RAG.1.2 M SRI Art. 1.53359.11 P/C.100

22207 MICRONEB.JSQ90 RAG 1.8 M SRI Art. 1.53360.11 P/C.100



**Accessori Per Condizionamento  
Attrezzatura Per R22  
Pompe Per Vuoto**



**Pompa per Vuoto MV  
3/2 ft 50 - REC**

**82500 POMPA x VUOTO MV 3/2 501** REC Art. 02002001 P/C.1



**Olio minerale per Pompa  
Kg. 1 - REC**

**82519 OLIO POMPA VUOTO 1 kg K IL** REC Art. 12002003 P/C.1

**82501 OLIO x POMPA MINER.kg 3.7** REC Art. 08711520 P/C.1

**Gruppi Manometrici**

O

**Giunto Diritto  
per pompa 1/4**

**82555 GIUNTO DR 1/4 PER POMPA** REC Art. 03241612 P/C.1

3



**Gruppo Manometrico  
2 vie SEC - REC**

**82517 GR. MANOM2VIE F2PF 80/A14** REC Art. 07604006 P/C.1

**82582 MANOMETRO ALTA PRES x R22** REC Art. 07602054 P/C.

4

**82583 MANOMETRO BASSA PRES x R22** REC Ad. 07602053 P/C.

**Tubi Flessibili**



**82507 SERIE 3 TUBI FLES 3W60x1.5** REC Art. 06030003 P/C.1

**„ Tubo Carica HDL  
60 mm x 1.5 - REC**

**82509 TUBO 1/4 FLES1.5MIT DIRITT** REC Art. 06007013 P/C.1

**82512 TUBO 1/4 FLES.1.5M SQ C/DE** REC Art. 07600066 P/C.1

**Cilindro Di Carica**



**Cilindro di Carica  
K2M - REC**

- Ricambio Esterno
- KCE2 - REC - In plexiglass
- Carta diagrammale
- REC - Per cilindro K2M
- Rubinetto di ricambio
- REC - Per cilindro K2M
- Asticella Pirex
- REC - Per cilindro K2M
- Serie guarnizioni 1/4"
- REC - Per cilindro K2M - Busta da 10
- Sigillante Leak Lock
- REC - Per cilindro K2M

**82503 DOS. CAR. CILINDRO K2 M** REC Art. 03021009 P/C.1

**82504 PELLICOLA x CILINDRO K2 M** REC Art. 07600222 P/C.1

**82508 RUBINETTO RIC x CILIND K2M** REC Art. 121 R.05016 P/C.1

**82598 ASTICELLA PYREX TIPO LUNGO** REC Art. 03099001 .AP P/C.1

**82505 CILINDRO RICAMBIO EST KCE2** REC Art. 07600280 P/C.1

**Valvolame**

ti

**Valvola di sicurezza  
per cilindro di carica.**

**82557 VALVOLA SICUREZZA V24** REC Art. 07600255 P/C.1

\*i)

**Valvolina Servizio ME  
Fil. 1/4 - REC**

**82558 VALVSERV 1/4 MMCVAL+CAP** REC Art. 03200103 P/C.1

ete

**Valvola di servizio  
KR512 2M - REC**

**82559 VALVSERV/SALD.MM6+VAL+CAP** REC Art. 05102028 P/C.1



**82549 VALVOLINA SCHRAEDER 870632** REC Art. 03200111 P/C.1



**82550** CAPPELOTTO x VALVOLINA REC Art. 03200112 P/C.1



**Cacciavite per valvoline  
CTW 1 - REC**

**82523** CACCIAVITE x VALVOL CTV 1 REC Art. 08008003 P/C.1



**Valvola girevole  
121 RG4 - REC**

**82560** VALVOLA GIREVOLE 121 RG-4 REC Art. 07600440 P/C.1

**Raccordi Aeroequip**



**Tronchetto rame Aeroequip  
C/ATT 1/4 - REC - Con diaframma**

- 82561** AEROEQUIP RAME C/A7T 1/4 REC Art. 03272005 P/C.1
- 82548** AEROEQUIP 3/8 A SALD C/VAL REC Art. 03270003 P/C.1
- 82562** AEROEQUIP RAME C/ATT 1/2 REC Art. 03272015 P/C.1
- 82580** TRONCHEITO CU ST80 5/8 AER REC Art. 03272120 P/C.1

**Giunti**

**Giunto Diritto  
U2-4 SAE 1/4 - REC**

**Giunto Diritto  
U2-4 SAE 5/16 - REC**

**Giunto Diritto  
U2-6 SAE 3/8 - REC**

**Giunto Diritto  
(.12-8 SAE 1/2 - REC**

**Giunto Diritto  
U2-10 SAE 5/8 - REC**



- 82565** GIUNTO DIR U2-4 SAE 1/4 REC Art. 05051014 P/C.1
- 82578** GIUNTO DIR U2-5 SAE 5/16 REC Art. 05051011 P/C.1
- 82566** GIUNTO DIR U2-6 SAE 3/8 REC Art. 05051016 P/C.1
- 82567** GIUNTO DIR U2-8 SAE 1/2 REC Art. 05051015 P/C.1
- 82568** GIUNTO DIR U2-10 SAE 5/8 REC Art. 05051017 P/C.1
- 82587** GIUNTO DIR U2-12 SAE 3/4 REC Art. 03240511 P/C.

**Giunti Ridotti**

**Giunto Ridotto  
UR2-64 1/4-3/8 - REC**

**Giunto Ridotto  
UR2 3/8-1/2 - REC**

**Giunto Ridotto  
UR2 112-5/8 - REC**

**Giunto Ridotto  
UR2 3/4-7/2 - REC**



**82569** GIUNTO DR RID UR2 1/4x3/8 REC Ad. 03240521 P/C.1

- 82570** GIUNTO DR RID UR2 3/8x1/2 REC Art. 05052021 P/C.1
- 82563** GIUNTO DR RID UR2 1/2x5/8 REC Ad. 05052029 P/C.1
- 82579** GIUNTO DR RID UR2 3/4x1/2 REC Art. 05052030 P/C.1

**Bocchettoni**

- Bocchettone  
NS4-4 1/4"**
- Bocchettone  
NS4-6 3/8"**
- Bocchettone  
NS4-8 1/2"**
- Bocchettone  
NS4-10 5/8"**
- Bocchettone 5/16 SAE**



- 82571** BOCCHETTONE NS4-4 1/4 REC Art. 05062008 P/C.1
- 82572** BOCCHETTONE NS4-6 TUBO 3/8 REC Art. 05062009 P/C.1
- 82573** BOCCHETTONE NS4-8 1/2 REC Art. 05062010 P/C.1
- 82574** BOCCHETTONE NS4-10 5/8 REC Art. 05062011 P/C.1
- 82554** BOCCHETTONE NS4-12 TUB 3/4 REC Art. 03240655 P/C.1
- 82575** BOCCHETTONE NS4-5 5/16 SAE REC Art. 05062012 P/C.1

**Bocchettoni Con Foro Ridotto**



- 82576** BOCCHETTONE NS4 3/8FORO 8 REC Art. 03240646 P/C.1
- 82577** BOCCHETTONE NS4-1/2FORO 10 REC Art. 03240647 P/C.1

**Riduzioni Ur**



**Riduzione  
UR 46 MF 1/4-3/8- REC**

**Riduzione  
UR3-86 MF 1/2-3/8- REC**

- 82526** RIDUZIONE UR3-86 MFI /2-3/8 REC Art. 03241669 P/C.1
- 82528** RIDUZIONE UR-46 MF 1/4-3/8 REC Art. 03241664 P/C.1

**Pinze Per Frigoristi**



**Pinza Schiacciatiubi  
Per tubi frigoriferi - COU**

**84141** PINZA SCHIACCIATUBI x FRIG COU Art. 08000036 P/C.1



**Lampade Cercafughe**

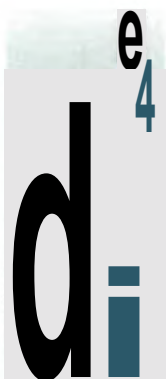

**Lampada Cercafughe LP 777 - REC**

82515 LAMPADA CERCAFUGHE TX 12A REC Art. 09001053 P/C.1



**Bomboletta Prop. LP 175 G 400 - REC**

82520 BOMBOLETTA PROP LP175 g400 REC Art. 07600155 P/C.1

**Strumenti Per Controllo Temperature, Umidità e velocità Aria**



Termometro Digitale da -50° a +150° C - VEM

59060 TERMOMETRO DIGIT -50°+150° VEM Art. VP010300 P/C.1



**Vantaggi:**

Apparecchio camino Economico'

Cappuccio di urotelioni per sensori  
Calcolo del punto di rugiada

**Applicazioni:**

- Controllo nei canali di ventilazione
- Misura nei canali di ventilazione
- Regolazione del clima

**Kit strumento con:**

- clip di fissaggio  
- manuale di istruzioni

Caratteristiche & unici*	testo 605
Campo mis.:	0,5 m/s (-20 .. 0°C) 0,10 m/s (-20 .. 50°C)
Risoluzione :	0,01 m/s 0,1°C
Precisione: (v.m. = valore misurato)	± 5% v.m. ± 0,1 m/s (fino a 2 m/s) t ± 0,3 m/s (> 2 m/s)
Alimentazione:	3 x AAA
Garanzia:	1

59071 IGROMETRO STICK STELO 605 TES Art. 0560.6051 P/C.1



**Vantaggi:**

Mini-anemometro la misura della velocità dell'aria e della portata da 0 a 10 m/s

**Applicazioni:**

- Controllo dell'aerazione alla e basa nel riscaldamento
- Controllo del funzionamento

**Kit strumento con:**

clip di fissaggio  
batteria e manuale di

Caratteristiche tecniche	testo 405
Campo mis.:	0,5 m/s (-20 .. 0°C) 0,10 m/s (-20 .. 50°C)
Risoluzione:	0,01 m/s 0,1°C
Precisione: (v.m. =valore misurato)	± 5% v.m. ± 0,1 m/s (fino a 2 m/s) t ± 0,3 m/s (> 2 m/s)
Alimentazione:	3 x AAA
Garanzia:	1

59072 ANEMOMETRO STICK 405 TES Art. 0560.4051 P/C.1

**Strumenti Controllo Pressione Per Caldaie**



**Caratteristiche tecniche testo 505**

mm H <sub>2</sub> O	Campo mis.:	da 0 a 130 mPa
mm Hg	Risoluzione :	0,1 mPa
	Precisione:	± 2% della scala
	Alimentazione:	Batteria 9V
	Garanzia:	Strumento 1 anno

**Vantaggi:**

Piccolo e compatto  
Montato da taschino

Ideale per l'installazione

Fissaggio magnetico integrato

Wfr.S.Sa 111\*1\*01

Commutazione in hPa, mmHg

Facile utilizzo e sostituzione delle pile

All'ospite

**Applicazioni:**

• Controllo della pressione differenziale su di un filtro

• Misura della pressione del tiraggio di una caldaia

• Misura del tiraggio di un camino

• Misura della sovrappressione/sovrappressione negli impianti di climatizzazione

**Strumento completo di:**

tubetti al silicone

- batteria e manuale di istruzioni

59070 MANOMETRO STICK 505 P1 TES Art. 0560.5051 P/C.1



**r**\_\_\_\_\_

**MANOMETRO  
AD "U"**

**Manometro a colonna d'acqua.  
Su base legno.**

**Lunghezza:** 600 mm

**Tubo:** Ø 6 x 10 - In sllcone - (conf: 10)

**58149 MANOMETRO A U 600 mm** FRR Art. 111266 P/C. 1



**58150 TUBO x MANOMETRO A U** FRR Art. 111268 P/C. 1



CO  
CO,  
O<sub>2</sub>  
'C  
tra  
TelMa

**Applicazioni:**

Il testo 325 è un analizzatore di combustione facile da usare, ideale per controlli di caldaie a gas

• Calcolo d'Iredo dei rendurien!

• Regola 7,00 Anni 3 Dresqlwie gas

•

Il kit comprende; strumento, sonda, stampante **infrarossi**, carta e valigetta.

Misura della temperatura

Campo di mis.:

Precisione:

Risoluzione:

Sensore:

Misura tiraggio/pressione

Campo di mis.:

Risoluzione:

Precisione:

Sovraccarico:

Calcolo della CO2

Campo di mis.:

Precisione:

Risoluzione:

Misura:

Tempi di risp.t90:

Misura di CO (solo per testo 325-1)

Campo di mis.:

Precisione:

(con ii2 < 10%)

Risoluzione:

Tempi di risp,t90:

Calcolo del rendimento

Campo Ci mis.:

Risoluzione:

Perdita del rendimento

Campo di mis.:

Risoluzione:

Misura di O2

Campo di mis.:

Precisionen:

Risoluzione:

Tempi di risp. t90:

Caratteristiche tecniche generali

Peso:

Dimensioni:

Temperatura di

traspistocc.:

Temp. lavoro.:

Alimentazione: alimentatore

Vita batteria:

Garanzia

Strumento:

Cella CO:

Cella O2:

Sande:

Accessori:

Stampante:

**59075 ANALIZZATORE FUMI 325.1** TES Art. 325.1 P/C

**Rilevatore Portatile Fughe Gas Metano E Gpl**



**RIVELATORE  
FUGHE GAS  
Portatile.  
A batteria.**

**58195 RILEV.PORT.FUGH.GAS SET100** FRR Art. 040260 P/C.1

**Cerca fughe R22 Con Lampada Stroboscopica**



**Lampada stroboscopica**

Con occhiali - Potenza: 100 W - REC

**82516 LAMPADA STROBOSC.220V 100W** REC Art. 05001040.43 P/C.1



**Additivo Cercafughe  
Contenuto 120 ml. • REC**

**82593 ADDITIVO x GLIM/REFI? 120ml** REC Art. 12001024-49 P/C. 1

**r**



**Pistola per Additivo  
- REC**

**82594 I'ISTOLA x ADDITIVO** REC Art. 14028008-47 P/C. 1

**Flessibile per Additivo  
- REC**

**82595 FLESSIB ADAT x TUBET ADDIT** REC Art. 14028009-AD P/C. 1



*Pulitore per Additivo  
Contenuto: 960 ml - REC*

**82596 PULITORE DI ADDITIVO 960ml** REC Art. 12001030-48 P/C.1

**Attrezzatura Per R410  
Pompe Per Vuoto**



*Pompa per Vuoto DIP 252/5*

**82513 POMPA VUOTO MOD. DIP 252/5** REC Art. DIP 252/5 P/C.1

**Olio Per Pompa**



**Olio per Pompa  
Kg. 1 - SINTETICO**

**82514 OLIO ESTERE LATTIN 11 SW68** REC Art. 12002004 P/C.1



**82525 OLIO ESTERE SW68 XR410 1LT** REC Art. 12002004 P/C.1

**r Gruppi Manometri&**



*Gruppo manometrico  
2 Vie - 5/16*

**82522 GRUP MANOMETRICO 2VIE 5/16** REC Art. F2PF80/A4/5 P/C.1

**Tubi Flessibili**



*Serie 3 flessibili  
Con Valvola interna  
e rubinetti*

**82524 SERIE 3 FLESS C/VALV INTER** REC Art. 3WSA/5.5/56V4BR P/C.1

**Bombole Gas Frigorigeni E Accessori**



**82542 GAS ALGOFRENE R 22** SLO P/C.1

**82533 GAS R410A MEFORX** SLO Art. 00781 P/C.1

**82543 AZOTO IND. BB** SLO P/C.1



**Riduzione bombola 5/16**

**82551 RIDUZIONE BOMBOLA 5/16** REC Art. 818/5 P/C.1



**82530 BOMBOLA VUOTA 12 1FREON22** REC Art. 08770201 P/C.1



**Riduzione Bombola R22  
SAE 1/45 - REC**

**82527 RIDUZ.BOMB.GAS.FREON 1/45** REC Art. 07600407 P/C.1



**Depressori/premiapillo  
per valvole Schröder.  
Confezione da 10 pezzi.**

**82531 SERIE DEPRESS.x TUBI IOPZZ** REC Art. 07600077 P/C.1



**Guarnizioni per tubi da 1/4 SAE**

**82529 SERIE GUARN.x TUBO 1/410P** REC Art. 14020014 P/C.1

## Raccordi



**Racc. Girevole 1/4"  
RG180 - REC**

**82584** RACCORDO DR-GIREV1/4RG180 REC Art. 07600203 P/C.1

**M.**

**Racc. Gir. Squadro 1/4"  
- REC**

**82585** RACCORDO GIREVOLE ANG. 1/4 REC Ad. 07600205 P/C.1



**Raccordo girevole 5/16 Fx1/4SA**

**82552** RACCORD GIREV 5/16Fx1/4 SA REC Art. RG-180-5/4M P/C.1



**Raccordo girevole 1/4SAEFx5/16**

**82553** RACCORD GIREV 1/4SAEFx5/16 REC Art. RG-180-4/5M P/C.1



**Girello cieco  
Con guarnizione - REC**

**82564** GIRELLO CIECO C/GUARNIZION REC Art. 07600411 P/C.1

## Chiavi Dinamometriche



**Chiave Dinamometrica 5/16  
17- 180 kg x cm  
Chiave Dinamometrica  
22 - 420 kg x cm  
Chiave Dinamometrica  
26 - 550 kg x cm  
Chiave Dinamometrica  
29 - 650 kg x cm**

**82588** CHIAVE DINAMOM 180kg. 17 REC Art. 08007009 P/C.1

**82589** CHIAVE DINAMOM 420kg. 22 REC Art. 08007010 P/C.1

**82590** CHIAVE DINAMOM 550kg. 26 REC Art. 08007011 P/C.1

**82591** CHIAVE DINAMOM 650kg. 29 REC Art. 08007012 P/C.1

## Accessori E Strumenti Per Impiantistica

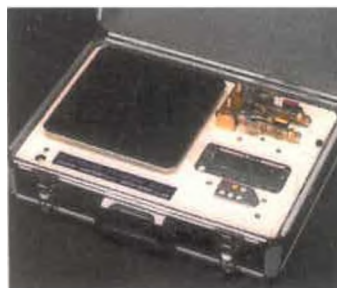

**Bilancia elettronica HPS-35/2/4-5  
doppio circuito di carica automatico.  
Portata max 35 kg.**

**82506** BILANCIA ELETT.DOP.CIRC REC Art. HPS 35/2/4-5 P/C.1



Il vacuometro digitale **TIF9450D** è uno strumento brevettato e si basa su una tecnologia non a termistore che non richiede nessuna calibrazione. Questo strumento segna valori di vuoto a partire da pochi micron fino ad arrivare a 760.000 micron I atmosfera, 760 mmHG, 0 psig) e non viene influenzato dal contenuto specifico del gas che viene evacuato.

### Caratteristiche:

- Display di 4 caratteri a cristalli liquidi che fornisce valori esatti del livello di vuoto
- Non viene influenzato dalla temperatura
- Doppia alimentazione elettrica: batteria a 9 volt o adattatore A/C (non incluso)
- Sensore non a termistore brevettato
- Risoluzione di 1 micron

**82521** VACUOMETRO DIGIT TIF 9450D REC Ad. TIF 9450D P/C.1



**Pettini per raddrizzare le alette degli  
scambiatori di calore con la possibilità di  
utilizzare: 8 - 9 - 10 - 12 - 14 - 15 mm.**

**82556** PETTINE x ALETTE PA 6 REC Art. 08008007 P/C.1





**82599 SIGILLANTE x FIL LEAKLOCK** REC Art. 12003002-10 P/C.1

**Flangiaterí**

Y t

**N. 458 Utensile per bordare**

Questo preciso apparecchio consente bordature pulite ed uniformi con minimo sforzo. La grande maniglia, opportunamente sagomata, permette una facile manovra. Il cono di bordatura, tipo a eccentrico in acciaio temperato. È montato su cuscinetti ad aghi ed agisce per rotolamento, producendo una deformazione graduale ed uniforme del metallo. senza provocare incrinature. Per alluminio\_ rame ricotto. acciaio inox, rame crudo e ottone.

Catalogo N.	Modello N.	Tipo	Dimensioni	Peso kp	Conf. Stel.
50257	458MM 45 SAE	Pane°	4.4.75.6. 8. 10. 12, 15. 16 mm	1,0	I

**82930 FLANGIATORE 4/16 458MM** RID Art. 50257 P/C.1



**N. 345 Utensile per bordare**

il Mod. 345 è un utensile di precisione per creare bordature a 45° in tubi di rame ricotto, ottone, alluminio ed acciaio dolce (JVC e Bundy). Il cono temperato ruota agevolmente su cuscinetti a sfere, consentendo di realizzare facilmente bordature di 45°. Una singola morsa a vite consente un semplice bloccaggio e rilascio del tubo.

Catalogo N.	Modello N.	Tipo	Dimensioni	Peso kg	Conf. Std.
23342	345MM 45 SAE	Rango	6, 8, 12 14 15 e 16 n	1,2	

**82931 FLANGIATORE 6/16 345MM** RID Art. 23342 P/C.1



**N. 458 Utensile per bordare**

Questo preciso apparecchio consente bordature pulite ed uniformi con minimo sforzo. La grande maniglia, opportunamente sagomata, permette una facile manovra. Il cono di bordatura, tipo a eccentrico in acciaio temperato. È montato su cuscinetti ad aghi ed agisce per rotolamento, producendo una deformazione graduale ed uniforme del metallo, senza provocare incrinature. Per alluminio, rame ricotto, acciaio inox, rame crudo e ottone.

Catalogo N.	Modello N.	Tipo	Dimensioni	Perito Conf. kg Stu.
36507	458 45 SAE	Flange		

**82934 FLANGIATORE 1/8-3/4 458** RID Art. 83037 P/C.1



**D escrivone** Per diametri,

**82998 FLANGIATORE UNIV. 525-F** REC Art. 08001001 P/C.1



D, st . zion • P. • diamo < - 4

**82999 FLANGIATORE x RAME 6-22 mm** REC Art. 08001003 P/C.1



**81085 TAGLIATUBO ROT. 1/8-2 390** PAS Art. 60200390 P/C.1



**81087 ROTELLA TAGLIATUBI 1/8-2** PAS Art. 602A0390 P/C.10

**81088 ROTELLA TAGLIATUBI 2-4** PAS Art. 602A0580 P/C.10

## Tegliatubi Per Acciaio E Accessori



N. 2.4

N. 3.5.4.5

Catalogo N.	Modello N.	Descrizione	Diametro nominale		Poso
			In.	mai D.E.	
32820	2-A	Per lavon pesanti		10-60	3,2
32830	3-S	Per lavon pesanti	1-3	34-89	6.9
12840	4-S	Per lavori pesanti	2-4	60-114	8,2

<b>82901</b>	TAGLIAT.x ACC. § 50 2-A	RID Art. 32820	P/C.1
<b>82902</b>	TAGLIAT.x ACC. § 75 3-S	RID Art. 32830	P/C.1
<b>82903</b>	TAGLIAT.x ACC. § 100 4-S	RID Art. 32840	P/C.1



I Catiatage N.	Modelao N.	Diametro nominale		Peso ke
		In.	mm D.E.	
32870	42-A	*1,-2	27-80	3,1
32880	44-S	21.4	76-114	9,1

<b>82904</b>	TAGLIAT. 4 ROT. 3/4-2 42-A	RID Art. 32870	P/C.1
--------------	----------------------------	----------------	-------

### Rotelle DI Ricambio Per Tagliatubi Suddetti



Rotelle

taglianti i It, :4.

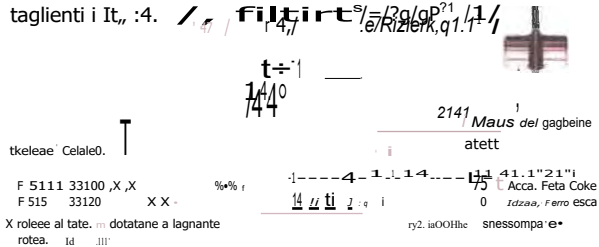

<b>83302</b>	ROTELLA TAGLIAT. 1-2 F-514	RID Art. 33100	P/C.12
--------------	----------------------------	----------------	--------

<b>83308</b>	ROTELLA TAGLIAT. 4 F-515	RID Art. 33120	P/C.12
--------------	--------------------------	----------------	--------

# RIDGID

## Tagliatubi Per Rame E Accessori



Tagliatubi Midget N.101, 103 e 104 Progettati per impieghi in spazi ristretti e diametri di dimensioni ridotte di rame crudo o ricotto, alluminio, ottone e plastica. Robusti, leggeri, con manopola di elevata dimensione che consente un facile e sicuro controllo della pressione di taglio e la realizzazione di tagli precisi e netti.

Catalogo N.	Modello N.	Descrizione	gotega, Capackk 'Pascè Cont.' Std.	mm	kg Std.
101	101	Tageat* tAdget cc* Tleka 'camar...			
103	103	Taguatutx Miape1	33185	3*16	0.1
104	104	Tagflawbi Minger	3185	5.24	0.1 i 6

<b>82940</b>	TAGLIATUBO 101	RID Art. 40617	P/C.1
<b>82910</b>	TAGLIAT.MIDGET RAME\$16 103	RID Art. 32975	P/C.10
<b>82911</b>	TAGLIAT.MIDGET RAME\$24 104	RID Art. 32985	P/C.10

N.150L

N.205

10



Le peculiarità del tagliatubo N.150L sono costituite dalla vite di avanzamento protetta, al fine di eliminare il bloccaggio per cause esterne, da scanalature dei rulli per consentire tagli vicino a punti di saldatura, e da un alesatore retrattile. In lega di alluminio ad alta resistenza, comprende una rotella di ricambio situata nella manopola. Adatto per tagliare tubi in rame, ottone ed alluminio, nonché conduit a parete sottile. Il modello 205 incorpora tutte le caratteristiche del N.150L, più un meccanismo ad avanzamento rapido.

Catalogo N.	Modello N.	Descrizione	Rotella Unitati mm	Pomo kg	Coni, Std.
66737	150L	Tagletubraavanzamento rapido		0.2	6
33055	205	Tagliatubi vavanzamento	J.111	0.6	1

<b>82912</b>	TAGLIAT. 150 L RAME\$35 150L	RID Art. 66737	P/C.1
--------------	------------------------------	----------------	-------

<b>82913</b>	TAGLIAT.205 RAME\$60 205	RID Art. 33055	P/C.1
--------------	--------------------------	----------------	-------

**Rotelle Di Ricambio Per Tagliatubi Suddetti**



**Rotelle 25 taglienti**

Tag: Si  
Modello N. Catalogo N.

Modello N.	Cont. Std.	Gmbh N.	X	X	X	XIX	X	X	ut In/ Appbce pone pr.
316/4	12	31185	X	X	X	XIX	X	X	4, A
315/6	6	33190							4, A

X e micron standard A

- 83309** ROTELLA TAGLIATUBI RAME/PL RID Art. 33185 P/C.12
- 82916** ROTELLA PER INOX x150-205 RID Art. 33190 P/C.12

**Tagliatubi Tube-Cutter Per Rame**



- 84144** TAGLIATUBO TUBE-CUTTER 28 cou Art. 04000259 P/C.1
- 84145** TAGLIATUBO TUBE-CUTTER 50 cou Art. 04010259 P/C.1

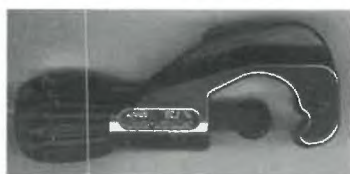

- 84149** TAGLIATUBO x RAME, φ 35 CRO cou Art. 04000007 P/C.1

**Rotelle DI Ricambio Per Tagliatubi Suddetti**



- 84531** ROTELLA TAGLIATUBO MOD 28 DAM Art. 3639 P/C.1
- 84171** ROTELLA RIC. 28/42 X 84144 cou Art. 04R10259 P/C.10
- 84172** ROTELLA RITAG.84145-84149 COU Art. 04018013 P/C.1
- 84176** ROTELLA RIC.INOX x TAGL 67 COU Art. 04R1R015 P/C.1



**TAGLIATUBI A ROTELLA**

- 25588** TAGLIATUBO DA 1/8 A 5/8 VLX Art. 1960089 P/C.1



**TAGLIATUBO A MANO**  
per tubi di rame, ottone, plastica, ferro.  
Per tubi da 1/8 a 1"1/8 - mm.28  
Confezione singola in Blister.  
Scatole da 10 pezzi.

- 88702** TAGLIATUBO A MANO 28 mm POG Art. 328.00 P/C.1

**Tagliatubi Per Plastica**



**Tagliatubi ad azione rapida**

I modelli dal 151 al 156 sono caratterizzati da avanzamento rapido della rotella, da corpo a sezione di I. da superfici di usura temperate e da un sistema di scorrimento delle guide particolarmente affidabile. Questi tagliatubi sono disponibili in versioni per tubi in plastica ed in metallo. I modelli 151 e 152 incorporano gli alesatori retrattili.

Catalogo N.	Modello N.	Rotella Std.	Capaciti mm	Peso kg	Conf. Std.
<b>Per tubi In Plastica</b>					
3164/	1'..t'	/41211 I	10.63	u 9	1

- 82918** TAGLIAT. AZRAP. PLAS63 152P RID Art. 31647 P/C.1

**Tagliatubi Per Plastica Super Ego**



- 84142** TAGLIATUBO 726 PLAST §50 cou P/C.1
- 84146** TAGLIATUBO SE x PLAST 67 COU Art. 0405E001 P/C.1
- 84147** TAGLIATUBOSExPLAST 127 COU Art. 0403E001 P/C.1
- 84148** TAGLIATUBOSExPLAST 168 cou Art. 0407E001 P/C.1

## Rotelle Di Ricambio Per Tagliatubi Suddetti



### Rotelle per PLASTICA

- |   |                          |
|---|--------------------------|
| <b>84175</b> ROTELLA RIC. X TAGL. 84146 | COU Art. 04R0R001 P/C.1  |
| <b>84173</b> ROTELLA RIC.x S/EGO 751-52 | COU Art. 0401 E009 P/C.1 |
| <b>84170</b> ROTELLA PN 16 D.127 290316 | COU P/C.1                |
| <b>84179</b> ROTELLA RIC. TAGL.PL 737   | COU Art. 0400E009 P/C.1  |



### Rotelle per METAW

- |  |                         |
|--|-------------------------|
| <b>84174</b> ROTELLA RIC.x S/EGO 1.1/4 | COU Art. 0401E010 P/C.1 |
| <b>84177</b> ROTELLA RIC.x S/EGO 2     | COU Art. 0400E010 P/C.1 |
| <b>84178</b> ROTELLA RIC.x S/EGO 4     | COU Art. 04000220 P/C.1 |



### TAGLIATUBI PER PLASTICA DI GRANDE VERSATILITA'

Utensili adatti al taglio manuale di tubi in materiale plastico, sia per condotte di scarico che in pressione, grazie alla loro lama speciale temprata ad induzione e lappata: con una penetrazione da 16 a 20.2 mm, sono in grado di eseguire il taglio di tubi in PE, PP, PPRandom, PB, PVDF e PVC, fino ad un diametro massimo di 140 mm.

- |                                       |                  |       |
|---------------------------------------|------------------|-------|
| <b>84515</b> TAGLIATUBI PER PE 140    | IDH Art. 3.158/  | P/C.1 |
| <b>84516</b> ROTELLE PER TAGLIAT. 140 | IDH Art. 3.158/1 | P/C.1 |



Attrezzo indispensabile per la preparazione dei tubi e dei raccordi prima della saldatura con manicotti elettrici.

Viene utilizzato per effettuare una corretta asportazione dello strato ossidato, causato dalla combinazione degli agenti atmosferici e dei raggi UV sulla superficie esterna.

Semplice da usare, e dotato di un dispositivo il quale permette che lo spessore del truciolo asportato sia costante in ogni condizione.

Campo di lavoro: 0 75 - 315 mm, max PN 16  
Lunghezza raschiatura: 0 - 180 mm.

Raschiatubo fornito con prolunghe, lama, chiavi di esercizio e cassetta di trasporto

- |                                  |                |       |
|----------------------------------|----------------|-------|
| <b>84517</b> RASCHIATUBI RTC 160 | IDH Art. 7.305 | P/C.1 |
|----------------------------------|----------------|-------|



**Raschiatubo R160 per tubi in materiale plastico da 0-160. Unico nel suo genere, esegue l'operazione di raschiatura in maniera semplice ed efficace, mantenendo costante lo spessore del truciolo asportato. Un pratico dispositivo permette di scegliere la lunghezza dell'intervento sul tubo è una serie di accessori rendono l'operazione di raschiatura maneggevole e sicura. Fornito in cassetta di materiale plastico con libretto d'istruzioni.**

- |  |                |       |
|--|----------------|-------|
| <b>45692</b> RASCHIATUBO § 50-160 X PE | IDH Art. 7.308 | P/C.1 |
|--|----------------|-------|

### Cassone Portautensili Da Cantiere



**Capacità: 0,45 m³  
Peso: 62 kg**

- |   |                     |       |
|---|---------------------|-------|
| <b>83620</b> CASSONE BASSO PORTAUT RS15 | RID Art. 88612-RS15 | P/C.1 |
| <b>83621</b> COPPIA LUCCHETTI x CASSONE | RH Art. 73616       | P/C.1 |



**FILIERE IN VALIGETTA**

Contenuto:  
 filiere da G3/8", G1/2",  
 G3/4", G7°,  
 portafiliera a cric reversibile,  
 prolunga per cric.  
**Scatole da 1 confezione.**

**25957 FILIERA IDRAULICO IN VALIG V L X** Art. 1452019 P/C.1

**Piller\* Manuale A Crilo R 200 Da 3/8 A 1,1/4 (380**



La filiera R-200 è più leggera ed è equipaggiata con nuovi pettini a bassa resistenza al taglio che comportano minor sforzo nel filettare. Le bussole complete di pettini sono intercambiabili con le filiere serie 11-R e possono essere impiegate nelle Nettatite' Modello 600 e 690.

Ceporetà irt.	Pose
------------------	------

**83302 FILIERA A CRICCO 3/8-1.1/4** RID Art. 37667 R-200 P/C.1

**Pettini Ricambio Per Filiera R200 (Rapi)**



**Pettini per filiere cricco R-200**

Iliaiseade (BSPT)	del tutto	poioiticat
	<b>4887</b>	
<b>83320</b> PETTINI x FIL. R200 3/8	RID Art. 38687	P/C.1
<b>83321</b> PETTINI x FIL. R200 1/2	RID Art. 38692	P/C.1
<b>83322</b> PETTINI x FIL. 8200 3/4	RID Art. 38697	P/C.1
<b>83323</b> PETTINI x FIL. R200 1	RID Art. 38702	P/C.1

**83324** PETTINI x FIL. R200 1.1/4 RID Art. 38707 P/C.1

**83325** PETTINI x FIL. R200 1.1/2 RID Art. 38712 P/C.1

**83326** PETTINI x FIL. R200 2 RID Art. 38717 P/C.1

**Bussole Ricambio C/Pettini Per R200 E 600c E 090c**



**Secondo Norme Inglesi ed Internazionali**

<b>Modello M R-200</b>			
(BSPT)			
Acciaio legato	0	37267	37272

Le filiere R-200 impiegano soltanto penin R-200 Non impiegano pettini 12M  
 Nota = DESTRO S SINISTRO

**83334 BUSSOLA BSPT x R200 3/8** RID Art. 37267

**83335 BUSSOLA BSPT x R200 1/2** RID Art. 37272 P/C.1

**Filiera Elettriche Portat**



Specifiche tecniche  
 Motore: Universale d:t 1020W 230V  
 Interruttore: A eva con sistema SICuref  
 za Interruttore separato per I inversione della rotazione.  
 Testa: Riduttore a ruota dentata e vite senta fine coi  
 eiementi montati su cuscinetti a sfere e ad agili a  
 intirificazioie permanente  
 Carter: In fusione di lega dalluming,  
 Corpo e manico: In putiesterre caricalo coi: libre di  
 vetro, ad alta resistenza.  
 Velocirà del mandrino: 31 gin,91!ritito id vuottij  
 Include bussole da: - 1 ity., R 2'101  
 Peso: 5.5 Isci senza otensit.  
 Braccio di supporto: No 601

Cotalaigo Modello PerAeralonw Poli., Pesa art

**83503 FILIERA PORTATILE MOD.600C** RID Art. 13571 P/C.1



**Specifiche Tecniche**

Motore: Universale da 1020W 230V  
 Interruttore: A leva con sistema di interblocco di sicurezza. Interruttore separato per l'inversione della rotazione.  
 Trasmissione: Ruota dentata e riduzione a serie di ingranaggi e cuscinetti ad aghi ed a lubrificazione permanente.  
 Carter: In fusione di lega d'alluminio  
 Corpo e manico: In poliestere caricato con fibre di vetro, ad alta resistenza  
 Velocità del mandrino: 32 giri/minuto (a vuoto)  
 Include bussole da: 1" 1 1/2 2" 2 1/2 3" 4" 5" 6" 8" 10" 12" 14" 16" 18" 20"  
 Peso: 8.5 kg senza utensili  
 Braccio di supporto: N 691  
 Anello bloccaggio bussola: per bussole da

Catalogo N.	Modello N.	Descrizione	Pettini	Peso kg
-------------	------------	-------------	---------	---------

DS.

**83504 FILIERA PORT. FINO 2 690C** RID Art. 41732 P/C.1

**Filiera A Banco**



**Equipaggiamento Standard**

Cavalletto: Modesto 1206  
 Teste portapettini: Modello 811\$  
 Pettini: " " 1 .2 ti5P1 f tiri '  
 Tagliatubi: Modello 360  
 Alesatore: Modello 341  
 Carrello: Modello 311 con leva guida N 312  
 Oliatore: Modello 330 (300AC)  
 Olio: 5 litri olio per filettare

**Specifiche Tecniche**

Motore: Universale reversibile da 1.5 kW con pompa olio ingranaggi incorporata. motorase. 230V  
 Interruttori: incassato per rotazione destra stop sinistra.  
 Interruttore integrale di sicurezza a pedale.  
 Mandrino: Rigido a chiusura rapida  
 Velocità del mandrino: 38 giri/min disponibile motore per 5/7" o 108 giri/minuto  
 Dispositivo di centraggio posteriore: Azionato camme

Catalogo N.	Modello N.	Descrizione	Completo -2 BSPT	Peso kg
-------------	------------	-------------	------------------	---------

AA

**83500 FILIERA MOD. 300AA C/TREP.** RID Art. 13191 P/C.1



**Specifiche Tecniche**

Motore: " " W 25 Nr  
 Controllo dei *mate*,  
 gale heavy-cluty per rotazione destra stop, pne;  
 tra oliu rnteauttoreal4'grale rii Sicurezza a  
 le  
**Velocità del mandrino** 38 giri/minuto  
**Mandrino** tipo a manalinea, con i nupri dell,  
 bilar, ciata  
 Dispositivo di centraggio posteriore  
 di Carnale  
**Sistema di lubrificazione** Luba-1 cacinne alte  
 rso la testa a mezzo di pompa ad  
 uioinnescaale a Sasso costante.

**Equipaggiamento Standard**

Testa Portapettini : MoOci.  
 815A (BSPT) . 2 apertura  
 automatici t) '  
**Pettini** : BSPT Lu •  
 De •  
 1'-2 BSPT Leo Do  
**Tagliatubi** : Modello 360  
 aulocentrante az:une illottée•  
 con rotella i t >t  
**Alesatore** : Modello 344 .  
 Olio 5 litri •> per +dettare

Modello N.	Descrizione
------------	-------------

**83502 FILIERA 300 COMP C/CAVALLE** RID M. 50697 P/C.1





Csakdого Modego M. N Tipo Sanno Lubril 1.ao Cap. Csp Sostku- Poog dagetturt filattatura kgagrate p.tti\*k tubo Da\*a lato kg  
Terga podapettbk BSPT

**83511 TESTA RICAMFIL 300 AUTOM** RID Art. 97080 815A P/C.1

**Pettini Per Filiera 815 Filare Banco (Bsp0)**



**Pettini per filiere universali (Ns. 504A, 811A, 815A, 856, 911 e 913)**

(8SPT)			
'Diametro nominale dei tubo • filetti per pollice'			
Materiale del pettini o tipo	4"-V-19	VA/."-14	1"-2"-11
Acciaio legato	D • 66660	18951	18961

**83522 PETTINI x FIL. 815 1/4-3/8** RID Art. 66660 P/C.1

**83523 PETTINI x FIL. 815 1/2-3/4** RID Art. 18951 P/C.1

**83524 PETTINI x FIL. 815 1-2** RID Art. 18961 P/C.1



**Pettini per filiere 141 Filiera regolabili**

Catalogo N. (13SPT) Brftish Standard Pipe Tapar - 4" - 11 TPI

Untene«, dei pettini o tipo

ACCiaio super ra

**83525 PETTINI x FILIERA 141** RID Art. 66625 P/C.1

**Accessori Per Filiera A 300 Per Filettare Fino A 4"**



**Filiera a demoltiplicazione N.141**

- La N.141 filetta tubi da 2i ". 3". 3f. 4" con un solo set di pettini.
- Uno speciale dispositivo di sgancio del mandrino evita inceppamenti.
- Semplice regolazione nella realizzazione di filettature coniche e parallele.
- Piastra a camme per la taratura istantanea delle misure.
- Solo filettature destre.

Cataboo (Modello N. N.	Descrtrione	Cepacrta Nom. del tubo in.	Paso kg
6538(1 '41	66P1 "Ur		42.3

**83203 FILIERA UNIVER.2.1/2-4 141** RID Art. 65380 P/C.1

**N. 758 Anello N. 844 Albero di trasmissione**

Catniago t Modelli° re	N.	~done	Peno kg
IS1 6.14	Adiello 000, aiocio di trasmissioni	.300 535	1 2.6

**83206 ANELLO FISSAG. FILIERA 758** RID Art. 19366 P/C.1

**83207 ALBERO TRASMIS. FILIER 844** RID Art. 42405 P/C.1

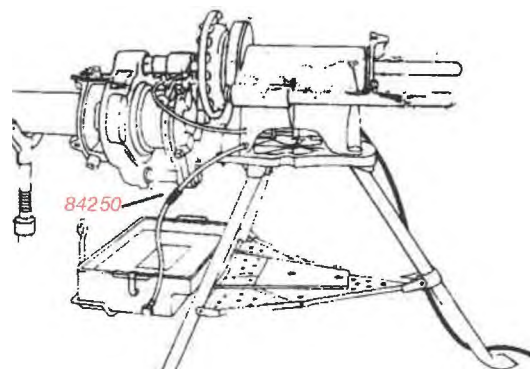

**84250 TUBETTO** RID Art. 16587 P/C.1

**Cavalletto Per Idraulico**



Banco trasportabile per tibi  
ACCIAIO 1100.2 1100-3

20,0 32,0

- 85401 CAVALLETTO x IDRAULICO 2 FZA Art. 1100-2 P/C.1
- 85402 CAVALLETTO x IDRAULICO 3 FZA Art. 1100-3 P/C.1

**Pettini Per Vecchie Piffero A Cric lir (13)**



Pettini per filiere a cricco 00-R. 111-R, 12-R, 0-R. 11-R o per filiere a 3 vie 30A. 31A

Galriopo N

aloto.ate era ~me o N» Duaneire flonunmo cm 8..8. + luatt, pot peoree  
tOsiPty emutA VoionOilffi P19\* rape.

- 83310 PETTINI x FIL. 11R 3/8 RID Art. 66120 P/C.1
- 83311 PETTINI x FIL. 11R 1/2 RID Art. 66125 P/C.1
- 83312 PETTINI x FIL. 11R 3/4 RID Art. 66130 P/C.1
- 83313 PETTINI x FIL. 11R 1 RID Art. 66135 P/C.1
- 83314 PETTINI x FIL. 11R 1.1/4 RID Art. 66140 P/C.1

**Olio Per Filettare**



Catalogo N.	Conleztotr	Peso kg	Cont Std.
11931		c.1 2	4
1531	25 Litri	23.5	1
15681	600 mi Soray	4.7	12

- 83610 OLIO x FILETT LATTINA L 5 RID Art. 11931 P/C 4
- 83612 OLIO x FILETT LATTINA L25 RID Art. 11531 P/C.1
- 83613 OLIO x FILETTARE SPRAY RID Art. 15681 P/C 12

**RIDGID**

**Cesoie Per Tubo In Plastica**



**Cesoie**

Realizzate per ottenere un tacine) netto preciso di tubi in plastica. Queste cesoie per plastica sono dotate c li t19 dispositivo a cricco con leveraggio a moltiplica e di lama in acciaio temperato.. l't taglio netto e veloce, e ottenuto facilmente con una soia mano.  
Non 7r:."102 per utst tnuCcArato,

Catalogo N	Modello N	Deurion*	Capacita mm	Peso kg	Coni Std
12821	1491	Ce80+8 per tubi d plastica		0.3	1
12841	1492	Cesoie per tubi cit olastica	i 4	0.5	1
12831	1493	Cesoie per i, L.'94sitett		1.2	1

- 82920 CESCOIExTUBO PLAST.§27 1491 RID Art. 12821 P/C.1
- 82921 CESCOIExTUBO PLAST.§42 1492 RID Art. 12841 P/C.1
- 82922 CESCOIExTUBO PLAST.§60 1493 RID Art. 12831 P/C.1
- 84295 LAMA x CESCOIA 1491 - 28 mm RID Art. 22066 P/C.1
- 84296 LAMA x CESCOIA 1492 - 42 mm RID Art. 22076 P/C.1



Catalogo N	Descrizione	Capacita mm	Peso kg	Coni Sto.
11.100*410				0s6

- 82923 PISTOLAxTUBO PLAST §32 1435 RID Art. 18351 P/C.1

**RIDGID**



**Trapano Stasatore Con 25 Piedi Di Sonda**



**Caratteristiche:**

- Powerfeed opzionale.
- Funzionamento a velocità variabile: da 0 a 600 giri/min.
- Doppio isolamento: 230V monofase, 3.2 AMP. 50/60 Hz, motore universale.
- Guscio in materiale anticorrosione ed antiurto che contiene il ctispenser dei cavi intercambiahile.



K-39.5 StasatoieK.39 K-39PF 36 i  
 'Cavo C-'  
 ' Nota torm o con Oispensor interno

82935 STASATRICE C/TRAP K 39-5 RID Art. 68127 P/C.1

**Piegatubo Per Ferro**



**Curvatubi idraulici ad azionamento manuale**

Catalogo Modello Descrizione Capacita Pressione Peso  
 N N N kN ha

**Capacità**

Diametro Spessore max.  
 Nominale del Tubo

82947 CURVAT. IDRAUL.MAN. 2 3802 RID Art. 13711 P/C.1

**RIDGID**

**Set Per Espansore Rame Dal 12 Al 18**



Cat. N.	Modello N.	Descrizione	Peso kg
10431	1)	SPI terAtne mm	

82925 ESPANS. RAME TEST12/18 D RID Art. 10431 P/C.1

**Curvatubi Per Rame A Cric**



P. lordo kg	Valigetta cm	P. corpo kg	Capacità
3,500	40x30x10	1,150	rame ricotto 10-22 rame riv. PVC 10-22 rame riv. morbido 10-22
Conf.	n. piastre ant.	n. matrici	Codice
10-22 R	2	8	CM 00260

71526 CURVAT RAME AMICA 3 10-22 RVR Art. CM00 260 P/C.1

**Curvatubi Per Rame Manuale**



**Per tubi Ø esterno mm. 6 8 10 12 14 16**  
 Raggio di curvatura mm. 11 14 23 30 42 54

- 84506 PINZA x RAME EST. 6 mm IDH Art. 4.111 P/C.1
- 84500 CURVATUBO MAN. RAME 8 mm COU Art. 0506E000428 P/C.1
- 84501 CURVATUBO MAN. RAME 10 MM COU Art. 0500E000428 P/C.1
- 84502 CURVATUBO MAN. RAME 12 MM COU Art. 0501 E000428 P/C.1
- 84503 CURVATUBO MAN RAME 14 MM cm) Art. 0502E000428 P/C.1
- 84504 CURVATUBO MAN. RAME 16 MM cou Art. 0503E000428 P/C.1

## Troncatrice Universale Da Banco



### N. 590 Troncatrice rapida a secco

Lama con denti riportati al carburo di tungsteno di speciale design. Non richiede lubrificanti o refrigeranti.

- Potenziata - La lama, diam. 14" 80T, con denti riportati al carburo di tungsteno di lunga durata, è adatta per tubi e condutture fino a 130 mm diametro esterno
- Sistema di bloccaggio professionale - per un lavoro veloce
- Angolo di taglio regolabile da 45° a 90°
- Motore P u potente da :2004
- F.,tfl'r Pps, snh 23 kg
- Bloccaggio del mandrino per una facile sostituzione della lama
- Proteggi lama, per una maggiore

Dimensioni della lama:

4 x 0 09: x801

(355mm x 2.4mm x 80 (denti))

Capacità massima	Tagli 90	Tagli 45	Catalogo N	Modello N	Descrizione	Peso kg
	130mm 5"	100mm 4"	17491	590	Troncatrice 230V 50Hz	22.0
	115 x 115mm 4 1/2" x 4 1/2"	90 x 90mm 3 1/2" x 3 1/2"				
	95 x 160mm 3 3/4" x 7"	90 x 100mm 3 1/2" x 4"				

83138 TRONCATRICE 590L 14 - 230V RID Art. 26641 P/C.1

## Carotatrici Ed Accessori



### Caratteristiche

- Motore da 1700W, 2 velocità (800/1570giri/min., 230V)
- Mandrino: (3:4) tiVu
- Frizione meccanica di sicurezza
- Protezione da sovraccarica
- Interruttore differenziale di sicurezza PRCDi

Cat N	Descrizione	Peso kg
53036	HC-2C carotatore a secco V; V; I la completo	7.2

82951 CAROTATORE C/KIT HC2 RID Art. 53036 P/C.1



Catalogo N.	Descrizione
52376	Prolunga da 300mm

82952 PROLUNGA 300 mm RID Art. 52376 P/C.1



Catalogo N	Descrizione	Peso kg
53046	Kit estrazione polveri	0,7

82954 KIT ASPIRAZIONE POLVERI RID Art. 53046 P/C.1

## Adattatori Per Mandrino Hc2



Catalogo N	Descrizione
52786	Da mandrino a 1/2" BSP (M)

82960 ADATTAT DA MANDR A 1/2 BSP RID Art. 52786 P/C.1



Catalogo N.	Descrizione
68516	Adattatore 1/2" BSP (F) a M16 (M)

82961 ADATTAT 1/2 BSP - M16 ADPT RID Art. 68516 P/C.1

## Supporti E Guide Di Centraggio



82957 SUPPORTO E PUNTA GUIDA 320 RID Art. 66996 P/C.1

82958 SUPPORTO E PUNTO GUIDA 430 RID Art. 57916 P/C.1

## Corone Diamantate Per Hc2 A Secco Cm 30 Attacco 1/2



Foretti PRE U	BSP (F).	per materiale duro
e	Lunghezza	Segmenti
mm	300mm	Cuantita
		tikaxsimr9 segmenti
52	62896	5
65	62906	6
82	62926	8
102	62946	10
127	62976	12
152	63006	14

82982 CORONA DIAM § 42 MM 30 CM RID Art. 62886 P/C.1

82983 CORONA DIAM § 52 mm 30 cm RID Art. 62896 P/C.1

82984 CORONA DIAM § 65 mm 30 cm RID Art. 62906 P/C.1

82985 CORONA DIAM § 82 mm 30 cm RID Art. 62926 P/C.1

82986 CORONA DIAM §102 mm 30 cm RID Art. 62946 P/C.1

82987 CORONA DIAM §127 mm 30 cm RID Art. 62976 P/C.1

82988 CORONA DIAM §152 mm 30 cm RID Art. 63006 P/C.1



Foretti	PREMIUM. 1/2" BSP (F), per matenele duro		
o	Lunghezza	Segmenti	Quantita
mm	150mm	bxaxs (mm)	segmenti
1.77	52806	12x7x3.5	4

82953 CORONA DIAMANT SEC 127 mm RID Art. 52806 P/C.1

**Corone Diamantate A Secco Cm  
15 Attacco M16 Con Fessure**



Foretti Premourn, M16 con feritene laterali			
	Lunghezza	Segmenti	Quantità
mm	150ram	bxaxs lrrnm)	segmenti
42	59086	12 x 7 x 3.5	4
52	59095	12 x 7 x 3.5	4
65	-91 I h	12 x 7 x 3.5	8
82	59136	12 x 7 x 3.5	8
102	Sq'fv	12 x 7 x 4	10
152	59'8t,		14

- 82970 CORONA DL4M § 32 mm RID Art. 59066 P/C.1
- 82971 CORONA DIAM § 42 mm RID Art. 59086 P/C.1
- 82972 CORONA DIAM § 52 mm RID Art. 59096 P/C.1
- 82973 CORONA DIAM § 56 mm RID Art. 64246 P/C.1
- 82974 CORONA DIAM § 65 mm RIO Art. 59106 P/C.1
- 82976 CORONA DIAM § 82 mm RID Art. 59116 P/C.1
- 82977 CORONA DIAM § 102 mm RID Art. 59136 P/C.1
- 82979 CORONA DIAM § 127 mm RID Art. 59166 P/C.1
- 82981 CORONA DMA( § 152 mm RID Art. 59186 P/C.1

**Kit Seghe A Tazza 22-29-3844-57-67**



Cat Modello N. Dozza 4 11 I'A IV: 21," 2,4 AMorcéltandrm p...  
220kn 24mm 30mm 44mm 57mm 577nm Re Ri R2 kg  
51490 1240 x i s

82996 KIT SEGHE A TAZZA SET 6PZ RIO Ari 81490 P/C.1

**Dischi Da Taglio**



Taglio a secco

Taglio veloce/preciso



Diam.(mm )	Diametro interno
115	22.2
125	22.2
180	22.2
230	22.2
300	20/22.2/25.4
350	25.4

Durata del disco: 149 togl  
Tempo/taglio: 429 sec.

83570 DISCO DIAMAN SEC §115x22.2 Riti Art. 21191 1 PIC.1

83571 DISCO DIAMAN SEC §230x22.2 RID Art. 21221 1 PIC.1



**DISCO DA TAGLIO GF 700 SPIRAL**

Disco placcato al cromo.

Taglio veloce e preciso.

Taglio a secco.

Indicato per

graniti, gneiss, arenaria molto dura, porfido.

Tempo medio di taglio: 522 secondi

N. medio di tagli per disco: 225

Dimensioni disponibili 0: 1 75 - 230 mm

83574 DISCO x GRAN SPIRAL § 115 RID Art. 23371 L P/C.1

83575 DISCO x GRAN SPIRAL § 230 RID Art. 23401 L P/C.1



**DISCO DA TAGLIO CK 700**

Taglio preciso.

Taglio a secco.

Indicato per

piastrelle di ceramica, piastrelle vetrificate,

terracotta, piastrelle in pietra naturale

(fino a 25 mm di spessore),

Tempo medio di taglio: 9 secondi (200 x 8 mm)

N. medio di tagli per disco: 2,134 (200 x 8 mm)

83577 DISCO X PIASTR CERAM § 115 RID Art. 24271 1 P/C.1

### Pinze Pappagallo Per Idraulico Alligator Knipex



81130 PINZA IDRAUL ALLIGATOR 25 OPB Art. 8801250 P/C. 1

81131 PINZA IDRAUL ALLIGATOR 30 OPB Art. 8801300 P/C. 1

### Pinze Pappagallo Per Idraulico Becchi Lisci Knipex



**Lunghezza:** 30 cm  
**Apertura ganasce:** max 42 mm  
**Confezione singola.**

81133 PINZA BECCHI LISCI KNIP 30 OPB Art. 8603250 P/C. 1

### Pinze Pappagallo Per Idraulico Cobra C/Bottone Knipex



81136 PINZA IDRAULICO COBRA 180 OPB Art. 8701180 P/C. 1

81135 PINZA IDRAULICO COBRA 250 OPB Art. 8701250 P/C. 12

81132 PINZA IDRAULICO COBRA 400 OPB Art. 8701400 P/C. 1

81134 ESPOSIT. 12 PZ COBRA 250 OPB Art. 8701250 P/C. 1



**PINZA REGOLABILE  
 MULTI POSIZIONE**  
 Con impugnatura  
 in resina termoplastica.  
 Misura: 250 mm.  
**Scatole da 12 pezzi.**

25945 PINZA REGOLAB MULTIPOS.250 vi.x Art. 1462608 P/C. 1

### Chiavi Per Idraulico



#### Chiave per interni

Molto utile per il fissaggio di nippli e raccordi con filettatura esterna, in quanto la presa all'interno del tubo non rovina la filettatura. Le ganasce zigrinate in acciaio ad alta resistenza si espandono con l'azione di un eccentrico e sono reversibili per diversi diametri (nippli da 1" fino a 2").

Catalogo Modello		Capacità		Peso kg	Conf. Std.
N.	N.	in.	mm		
r	31405	342	1.2 25.50	C 7	
<b>83100</b>	<b>CHIAVE x INTERNI</b>	342		<b>RID</b> Art. 31405	P/C.1



Catalogo Moder»		Descrizione	Dimensione		Capacità tubo	Pesi Cont.
N.	N.		In.	mm	In.	kg Std.
31175	1017	i Man telescopico	10-17	250-425	17.43	0.9
<b>83102</b>	<b>CHIAVE x ATTACCHI 1017</b>				<b>RID</b> Art. 31175	P/C.1



Catalogo Ifaodol		DC5CfZione	Dimensione mm	Capacità tubo		peso Cont. kg Std.
N.	N.			in	mm	

**83123** CHIAVE PER ESAGONI SUPERAN **RID** Art. 31305 P/C.1

**111113i,**

**84126** CHIAVE BLITZ PKS DIR. 175 COU Art. 03000062 P/C. 1

**84127** CHIAVE BLITZ PKS DIR. 225 COU Art. 03010062 P/C. 1

**84128** CHIAVE BLITZ PKS DIR. 275 COU Art. 03020061 P/C. 1

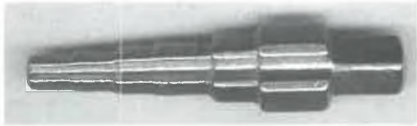

**84137** CHIAVE UNIVERSA SCALINO cou Art. 03000010 P/C.1



**84828** LEVA CRICCO x RADIAT. 450 cou Art. 03000018 P/C.1

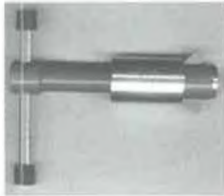

**84138** CHIAVE x PILETTE DOPPIA M cou Art. 08000062 P/C.1

**Chiavi Per Radiatori**



**84831** CHIAVE RADIAT. 500 mm 1 cou Art. 03000128346 P/C.1

**84832** CHIAVE RADIAT. 750 mm 1 COU Art. 03000129346 P/C.1

/Romania, amammo



**84833** CHIAVE RADIAT. 500 mm 1.1/4 COU Art. 03010128346 P/C.1

**84834** CHIAVE RADIAT. 750 mm 1.1/4 COU Art. 03010129346 P/C.1



**84164** CRICCO x COD ULI MASTER cou Art. 08000830 P/C.1

**Giratubi  
Giratubi Diritti Manico Pesante**



**Giratubi diritto**

Robusto corpo in ghisa e manico a sezione di "I" con ganasce a completo flottaggio, regolazione del nottolino con ganasce e ganaschini sostituibili.

Catalogo N.	Modello N.	Dimensione		Capacità tubo In. mm 12.E	Petto kg	Coni. Std
		in	mm			
31010	10	10	250			
31015		12	300	60		
31025	18	18	450	76		
31030		24	600	89	4n	
31110	36		900	141	8,7	

**83107** GIRATUBO DIRITTO 1.1/2 10 RID Art. 31010 P/C.1

**83108** GIRATUBO DIRITTO 2 12 RID Art. 31015 P/C.1

**83110** GIRATUBO DIRITTO 2.1/518 RID Art. 31025 P/C.1

**83111** GIRATUBO DIRITTO 3 24 RID Art. 31030 P/C.1

**83112** GIRATUBO DIRITTO 5 36 RID Art. 31035 P/C.1

**Giratubi Diritti Manico Alluminio Leggero**



Giratubo diritto con manico in lega d'alluminio. Circa il 40% più leggero di un equivalente modello in ghisa. Le ganasce e tutte le altre parti sono identiche al giratubo per impieghi pesanti.

Catalogo N	Modello N	Dimensione		Capacità tubo In. mm	Petto mm	Coni. Std
		in	mm			
31095	814	14	350	2	60	1.1
31100	818	18	450	2	76	1.2
31105	824	24	600	3	89	1.3
31110	836	36	900	5	141	1.4

**83115** GIRAT. DIR. ALL.1.1/2 810 RID Art. 31090 P/C.1

**83116** GIRAT. DIR. ALL.2 814 RID Art. 31095 P/C.1

**83117** GIRAT. DIR. ALL.2.1/2 818 RID Art. 31100 P/C.1

**83118** GIRATUBO DIRITTO ALL.3 824 RID Art. 31105 P/C.1

**83119** GIRATUBO DIRITTO ALL.5 836 RID Art. 31110 P/C.1

**83120** GIRATUBO DIRITTO ALL.6 848 RID Art. 31115 P/C.1



Catalogo No	Modello No	In. mm	Capacità tubo (r)	Peso Cont. kg	Coni. Std.	
19291	S 2"	21"	534	2"	70	2.6 6

**83106** GIRATUBO 2 MANICI 2 RID Art. 19291 P/C.1

**Ganasce Di Ricambio Per Giratubi Precedenti**

**Parti di ricambio**



Dimensione men., giratura	Capacità tubo	Kit sp. n. garlMSCirr.	Gen. Ad
1111/9		Cet. t	Cisti. r
14	350	31700	31695
18	450	31725	31700
24	600	31750	31705

**83167** GANASCE x 824 RID Art. 31695 P/C.1

**83179** GANASCINO C/PERNO x 824 RID Art. 31700 P/C.1

**83166** GANASCE x 836 RID Art. 31720 P/C.1

**83178** GANASCINO C/PERNO x 836 RID Art. 31725 P/C.1

**83165** GANASCE x 848 RID Art. 31745 P/C.1

**83177** GANASCINO C/PERNO x 848 RID Art. 31750 P/C.1

**RIDGID**

### Giratubi A Catena

"4,4 00111111h

Cat. (Ogo. M.)	Wg. (1) Pi.	Dewition. Lung. (1)	Qualità	---	r. E. j	Lu	Ar	Pnoi C.M.
		mm	t. ill.	i	mie D.E.	1071	ram tn.	: mr0
31310	11-12	imp,leggen						
31315	C-14	Imp pesai>	320	2	60	5	12 i 10 •	602 12
31320	0-18	imp pesani	435	2	76	5	125 20	5001 2.7
31325	C-24	Imp.pef.anhi	580	3	69	5	125 i209.	5001 3.7
31330	C-36	I imp00san0	700	4	110	7	85 29	725 i

- 83130** GIRAT. A CATENA 50 mm C-12 RID Art. 31310 P/C.1
- 83131** GIRAT. A CATENA 50 mm C-14 RID Art. 31315 P/C.1
- 83132** GIRAT. A CATENA 60 mm C-18 RID Art. 31320 P/C.1
- 83133** GIRAT. A CATENA 75 mm C-24 RID Art. 31325 P/C.1
- 83134** GIRAT. A CATENA 110mm C-36 RID Art. 31330 P/C.1

### Giratubi Svedesi



#### GIRATUBI MOD. SVEDESE ORIGINALE "VBW MOD. 110

in acciaio cromo-vanadio, ganasce • i 90

5.095 per tubi 3'  
5.096 per tubi 4'

- 84844** GIRATUBO SVEDESE MOD.110 3 IDH Art. 5.095 P/C.1
- 84845** GIRATUBO SVEDESE MOD.110 4 IDH Art. 5.096 P/C.1

011111S

- 80916** GIRAMI SVEDESE 45° 320 PAS Art. 52500320 P/C.1
- 80917** GIRATUBI SVEDESE 45° 420 PAS Art. 52500420 P/C.1
- 80918** GIRATUBI SVEDESE 45° 550 PAS Art. 52500550 P/C.1

### Gelerm

- 80920** GIRATUBI SVEDESE SAGOM335 PAS Art. 525K0320 P/C.1
- 80921** GIRATUBI SVEDESE SAGOM.430 PAS Art. 525K0410 P/C.1
- 80922** GIRATUBI SVEDESE SAGOM550 PAS Art. 525K0560 P/C.1

A	B	3	ED		
320	50	1"		800	?
410	80	1 1/2"		1350	?
540	80	2"		2460	?
585	105	3"		4250	?

- 80929** GIRATUBI SQUADRO 90° 320 PAS Art. 526S0310 P/C.1
- 80930** GIRATUBI SQUADRO 90° 410 PAS Art. 526S0420 P/C.1
- 80931** GIRATUBI SQUADRO 90° 540 PAS Art. 526S0560 P/C.1
- 80932** GIRATUBI SQUADRO 90° 685 PAS Art. 526S0685 P/C.1

### Giratubi A Ganaschia Ex Dowidat Oggi Sandwik



### SAN DVI K

- 84300** GIRATUBO GANASCIA SQ 1 SAN Art. 175 T P/C.1
- 84301** GIRATUBO GANASCIA SQ 1.1/2 SAN Art. 175 T P/C.1
- 84302** GIRATUBO GANASCIA SQ 2 SAN Art. 175 T P/C.1
- 84303** GIRATUBO GANASCIA SQ 3 SAN Art. 175 T P/C.1
- 84304** GIRATUBO GANASCIA SQ 4 SAN Art. 175 T P/C.1



Giratubi regolabile a rullino  
con ganasce piegate a 90°, in acciaio speciale.  
Trattamento supplementare di indurimento  
delle ganasce.  
Esecuzione verniciata.

Lungh. 340 mm (tubi fino a 1")  
Lungh. 440 mm (tubi fino a 1.1/2")  
Lungh. 580 mm (tubi fino a 2")

- 84430** GIRATUBO REGOLAB 90° 1 SO VEP Art. 0227/340 P/C.
- 84431** GIRATUBO REGOL.90° 1.1/2 SQ VEP Art. 0227/440 P/C.
- 84433** GIRATUBO REGOLAB 90° 2 SQ VEP Art. 0227/580 P/C.

### Banchi' Da Lavoro



Catalogo N.	Modelle N.	Descrizione	Capacità tubo	Peso Cont.
			t in. mm D.E.	kg Std.
4,	11.....	.....,l',.,,	4., "., +.d	4.

- 83141** BANCO CON MORSA A CATENA RIO Art. 72037 P/C.1

# RIDGID



### Banchi da lavoro

I banchi da lavoro N.1100. 1300 e 1400 sono costruiti con solida struttura. hanno un ripiano di lavoro in duro legno trattato per resistere all'usura a liquidi ed alla polvere, Sono facilmente montabili e smontabili, sono leggeri e. quindi. facilmente trasportabili.

Catalogo N.	Modello N.	Dimensioni	Piero kg
16601	110	83 x 52 cm	21,0
16361	1300	107 x 62 cm	34.0
15841	140	107 x 75 cm	40.0

**83146** BANCO LAVORO 107x75cm 1400 RID Art. 15841 P/C.1

### Morse Per Banchi Da Lavoro



Morsa tubi t A411/11  
**ACCIAIO** Kct 8,0

**85411** MORSA PER TUBO RIBALTAR. 2 FZA Art. 1000-2 P/C.1



morsa per tubi fissa  
**ACCIAIO** Kq 21,0

**85413** MORSA PER TUBO FISSA 4 FZA Art. 1001-4 P/C.1



**MINI**  
Ganasce: 100 x 11 mm  
Apertura: 80 mm  
R **Peso:** 7,5 kg

**MIDI**  
Ganasce: 125 x 11 mm  
Apertura: 100 mm  
**Peso:** 10,5 kg

**20045** MORSA BANCO PROFES 100x11 VEP Art. 0031/100 P/C.1

**20046** MORSA BANCO PROFES 125x11 VEP Art. 0031/125 P/C.1

### Seghetto Elettrico A Gattuccio



### Caratteristiche:

- Potente motore da 1200W\_
- Azione alternativa ed orbitale. previo comando di un interruttore.
- Regolazione elettronica della potenza.
- Velocità regolabile da 800 a 2400 giri/minuto.
- Taglia tubi fino a 4".
- Usando lame supplementari taglia tubi in acciaio inox.
- Protezione elettronica da sovraccarichi.
- Pesa solo 3.2 kg.

Calatoci° N.	Rimodella N.	Descrizione	Peso kg
230V			
16341	550.1	Seghetto alternativo 1200W completo di staffa a catena da 6 lame e cassetta metallica	

**83526** SEGHETTO ALTERNATIVO 550 RID Art. 16341 P/C.1



Catalog* N.	Modello N.	Lunghezza inch mm	CX22,*	Coloro	Itpa appacazione
12266		6	14(1	8	Rossc 11,\$,S, Ts,r in ar.c.,«Lr
3227f		P	A	Ra65, 6	H.S.S. • T.i .n auto...

**83527** LAMAxSEGHETTO ALT 2 D1004 RID Art. 32266 P/C.1

**83528** LAMAxSEGHETTO ALT 4 D1005 RID Art. 32276 P/C.1

# RIDGID

**CongelabJbi Elettrico Fino A 1,1/4**



SF-2100: Per tubi in acciaio da i4 a e in rame da 10 mm a 42 mm Tubi in gomma da 1.8 m.

Catalogo N	Descrizione	Peso kg
------------	-------------	---------

Compressore rotativo da 379W.

83164 CONGELATUBI SF-2100 RID Art. 68837 P/C.1

**Videocamera Miniseesnake Con Sonda Da 15 Mt**

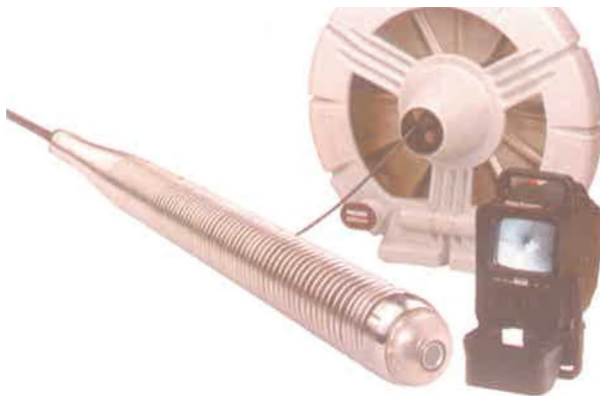

**RIDGID**

- LAT PACK pu0 essere impiegato in linee a 40 a 150mm.
- ia videocamera e cosi robusta da funzionare ad una profondita di 100m. di colonna d'acqua.
- l'illuminazione da LED all'infrarosso aumenta il campo visivo. Si vede di piu con il FLAT PACK che con una videocamera a LED a luce rossa.
- il diametro ridotto della videocamera (solo 31 mm ) consente di superare agevolmente curve a 90' in .ibazioni da 42mm.
- ; cavo da 6,6mm. di diametro ha una rigidita sufficiente per essere spinto per lunghe distanze, pur mantenendo un'agilita sufficiente per superare gomiti e curve.
- trasmettitore di segnale, incluso.
- lo speciale design dei tamburo porta-cavo consente una facile pulizia del cavo, evitando di sporcare l'area di lavoro circostante.

Specifiche tecniche

- Cavo • lun lhezza 30m diametro 6.6mm
- Videocamera: 26 LED all'infrarosso
- .
- . t . J.l 4.4v ;non ncrusa di l d- lavoro da a 50 O.
- Peso: 8kci

83640 VIDEOCAMERA x ISPEZIONI RID Art. 67267 KD-10 P/C.1

**Pompe Provaimpanti**



**N. 1450 Pompa provaimpanti**

aratteristica unica di Questa attrezzatura ..ostiluita dal braccio a ieveraggio variabile e dalla valvola cm non ritorno automatica tanuta dl piessinne imo ecinsente ..emplice pressurizzazione del sii..teirta fluidi compatibili sono acqua olio e ici., riii

- , pressione s' mantiene custame automaticamenc.r Non ci sono vaivole da chiuderne manualmente
- Int 3,1;11,1 FIOCA U. C,ari Lt al pe uno maCRI un

Catalogo N.	Modello N	Descrizione	Peso kg
-------------	-----------	-------------	---------

83160 POMPA PROVAIMP. 50BAR 1450 RID Art. 50072 P/C.1





**N. 1460-E Pompa Elettrica Provaimpianti**  
 Velocita di pompaggio regolabile  
 Manometro di pressione  
 Serbatoio di regolazione per il  
 controllo della pressione  
 Elettrodomestico a 230V  
 Elettrodomestico a 230V  
 Elettrodomestico a 230V

- Caratteristiche:**
- Pompa a bassa pressione, alta efficienza e durata superiore. Incremento graduale della pressione.
  - Sistema ad attacco rapido per il cambio di tipo di attacco. Manometro di pressione a lettura diretta.
  - Serbatoio in acciaio inox da 10 litri.
  - Portata 9 litri/min.

Catalogo N.	Modello N.	Descrizione	Peso kg
19021	1460-E	Pompa provaimpianti elettrica 230V. 25 Bar	20
43666		Blocco or regolazione 25 Bar	

**83162 POMPA PROVAIMP ELET 25 BAR** RID Art. 19021 P/C.1  
**83163 BLOCCO REGOLAZIONE 25 BAR** RID Art. 43666 P/C.1



**84519 POMPA COMBINATA (DIS+PROV)** COU Art. 09000029900 P/C.1



**POMPA 'DRAUICA PER COLLAUDO IMPIANTI**

Per prove pressioni in tubi o serbatoi: con prolunga in gomma per alta pressione da 800 mm.  
 Pressione max 60 atm.  
 Capacità serbatoio Lt 11. Modello verticale

**84518 POMPA PROVA IMPIANTI RIEM** IDH Art. 6.031 P/C.1

**Saldatori A Gas**



**Torcia a propano Piezomatic**  
 Accensione a pulsante. Il bruciatore ad alta velocita riscalda rapidamente i tubi per saldature e brasature torti. Temperatura della fiamma 1900 C (temperatura d'esercizio 950 C). Pressione di funzionamento 4 bar t58 PS11. Fornita con bruciatore da 19 mm. Sono disponibili anche bruciatori da 13 e 16 fil m.

Cat. N.	Descrizione	Peso kg
18011	Torcia a propano piezomatic con bruciatore da 19 mm	

**82995 TORCIA PIEZOMATIC** RID Art. 18011 P/C.1



**84121 CERCOFLAMBLISTER 5653 EXP cou** Art. as000cgo P/C.1

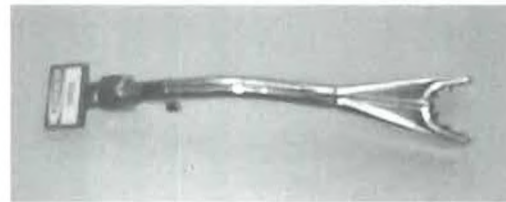

**84124 LANCIA EXPRESS 1655 D.24** COU Art. 06000010 P/C.1



**84125 LANCIA EXPRESS 1656 D.44** COU Art. 06000011 P/C.1

## Congelatore Eskimo 2



««qe M981111884

«4110»  
eé

**84132** CONGELATORE ESKIMO 2      COU Art. 0800RE02 P/C.1

### Scovo!! Per Caldaie

tee>>~O§Resmommue

<b>55784</b> SCOVOLO x CALDAIA 20 mm	RGH Art. 94002	P/C.1
<b>55785</b> SCOVOLO x CALDAIA 30 mm	RGH Art. 94003	P/C.1
<b>55786</b> SCOVOLO x CALDAIA 40 mm	RGH An. 94004	P/C.1
<b>55787</b> SCOVOLO x CALDAIA 50 mm	RGH Art. 94005	P/C.1
<b>55788</b> SCO VOLO x CALDAIA 60 mm	RGH Art. 94006	P/C.1
<b>55789</b> SCOVOLO x CALDAIA 70 mm	RGH Art. 94007	P/C.1
<b>55790</b> SCOVOLO x CALDAIA 80 mm	RGH Art. 94008	P/C.1

### Pezzi Di Ricambio Per Utensili Ridgid

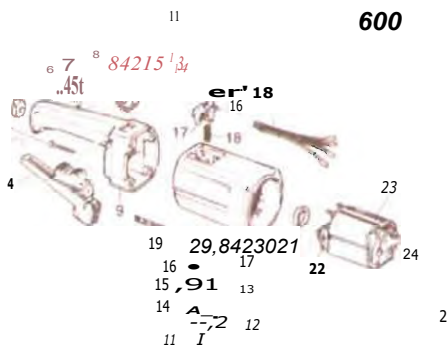

<b>84215</b> INVERTITORE x 114-600-690	RID Art. 20516	P/C.1
<b>84230</b> CARBONCINI x 114-600-690	RID Art. 20306	P/C.1

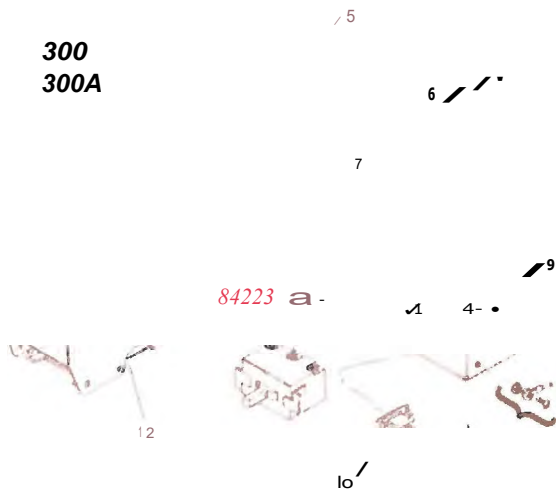

**84223** INTERRUTTORE      RID Art. 44505      P/C.1

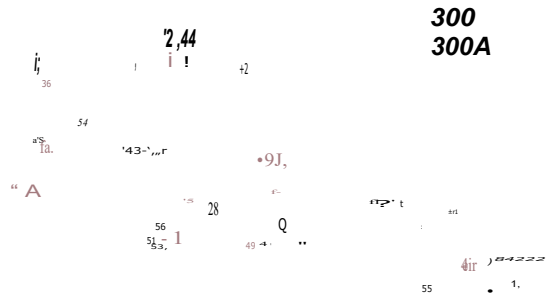

**84222** SERIE INSERTI      RID Art. 44715      P/C.1

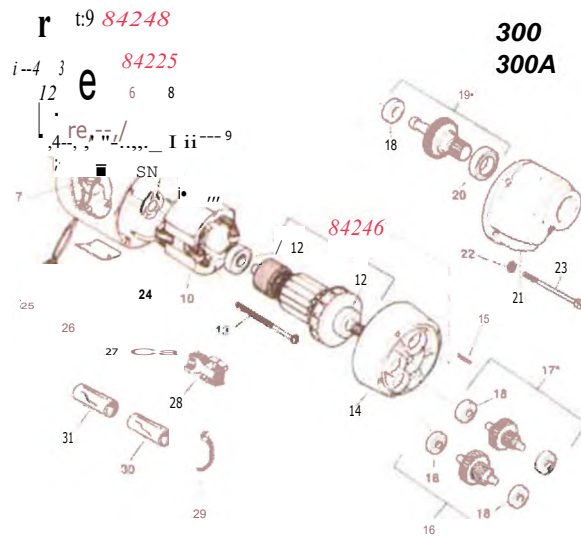

<b>84225</b> CARBONCINI	RID Art. 44540	P/C.1
<b>84246</b> INDOTTO	RID Art. 44030	P/C.1
<b>84248</b> COPERCHI	RID Art. 44545	P/C.1

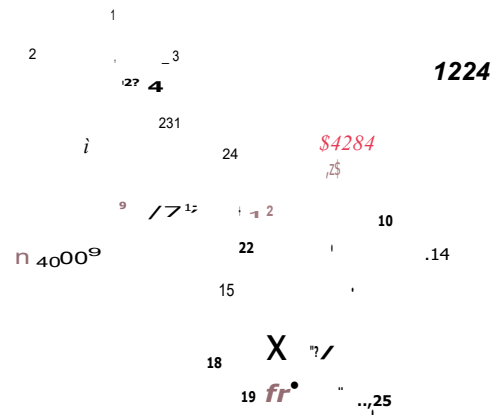

**84284** RONDELLA      RID Art. 26957      P/C.1

### 815A

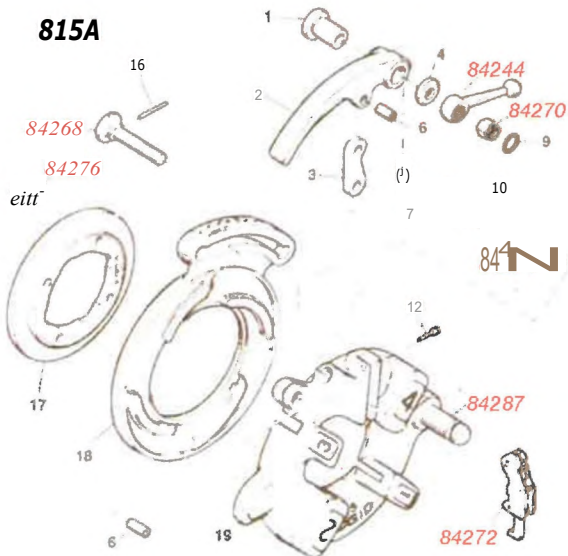

<b>84244</b> LEVA x 855-815	RID Art. 44260	P/C.1
<b>84268</b> VITE	RID Art. 44235	P/C.1
<b>84270</b> DADO	RID Art. 44250	P/C.1
<b>84272</b> GRILLETTO	RID Art. 44285	P/C.1
<b>84274</b> MOLLA	RID Art. 11565	P/C.1
<b>84276</b> VITI	RID Ari. 32205	P/C.1
<b>84287</b> PERNO x TESTATA	RID Art. 59832	P/C.1

### 300A

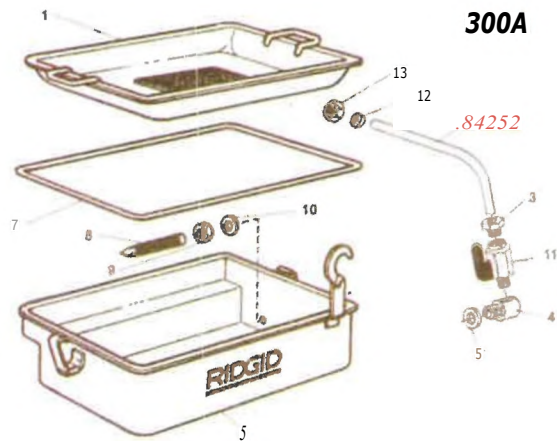

<b>84252</b> TUBO LUBRIFIC	RID Art. 19336	P/C.1
----------------------------	----------------	-------

### 811A



<b>84278</b> LEVA	RID Art. 46520	P/C.1
<b>84280</b> VITE	RID Art. 39860	P/C.1
<b>84282</b> LEVA	RID Art. 39950	P/C.1

### 84292 = ALESATORE COMPLETO

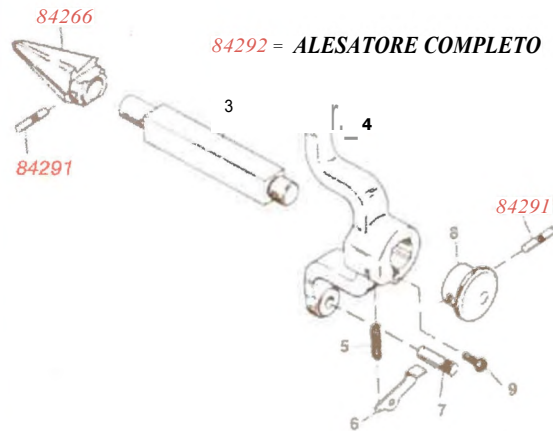

<b>84292</b> ALESATORE COMPLETO	RID Art. 42365	P/C.1
<b>84291</b> SPINOTTO	RID Art. 47155	P/C.1
<b>84266</b> CONO ALESAT	RID Art. 36277	P/C.1

### 300A

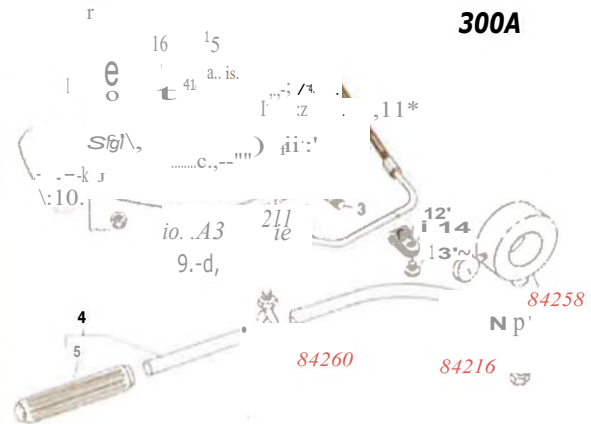

<b>84258</b> ANELLO	RID Art. 46215	P/C.1
<b>84260</b> ANELLO	RID Art. 46205	P/C.1
<b>84216</b> VITE E515 - 312	RID Art. 46210	P/C.1



**Per la pompetta dell'oliatore mod. 318**

<b>84286</b> TUBO OLIO	RID Art. 41775	P/C.1
------------------------	----------------	-------



<b>84256</b> OLIATORE	RID Art. 72327	P/C.1
-----------------------	----------------	-------



Nr. 127 alesatori interno-esterno  
 Per una rapida e facile operazione di fresatura interna e smussatura  
 esterna di tubi da a 1". Corpo in plastica con comoda presa. Lama  
 in acciaio di ampia superficie protetta contro rotture o urti. Garantiscono  
 una rapida e professionale fresatura di tubi in rame, alluminio ottone ed  
 altro materiale

Catalogo	Modello	Cap« ets	Peso Conf.
N	N.		g Std.

**82949 ALESATORE MOD.127** RID Art. 34965 P/C.1

**Utensili Per Idraulica**



**84507 PINZA ALLARGA TUBO PIOMBO** IDH Art. 5.410 P/C.1



**84508 NETTATUBI N.1 1.5 m** LEO Art. 1841 P/C.1



**NETTATUBI A MOLLE**

Per le guarnizioni di tubazioni ostruite: con maniglia in  
 legno lunghezza mt 5.0

**84514 NETTATUBI A MOLLA cm 500** tMV Art. 011575 P/C. 1

**RIDGID**



**ARCHETTO MIGNON**  
 in acciaio tondo mm 6.  
 Verniciato a forno.  
 Per lame da 6".  
 Peso: 92 gr.  
 Imballo: 12 pezzi

**84509 ARCHETTO SEGHETT. MIGNON** CAF Art. 520 P/C.10  
**84513 LAMA RICAMBIO METALL.** CAF Art. 572 P/C.1

al>>



**RETTIFICATORI PER SEDI DI RUBINETTI**

dri f

2 4

**84511 FRESA PER RUBINETTI 3/8-1** COU Art. 08010272 P/C 1  
**84512 FRESA RICAMBIO 1/2** IDH Art. 8.453/R2 P/C. 1



**CALIBRO A CORSOIO**

Calibro a corsoio composto. nonio 1/20 mm.  
 allungato. in acciaio inox cromato opaco  
 Scala graduata in mm e pollici. tabella dei pesi  
 sul retro dell'asta, astina per misure di profondità.  
 Confezione in fodero di Vipla,  
 Scala: 160 mm.  
 Lettura utile 135 mm.

**84535 CALIBRO CORS.INOX 135 mm** IDH Art. 8.140 P/C.1  
**84536 CALIBRO CORS.INOX 153 mm** IDH Art. 8.141 P/C.1



**84575 BORSA IDRAULICO 55x18** EUC Art. 323/55 P/C.1



Speciale finitura delle ganasce per consentire una perfetta aderenza su tutto il campo di presa

- Arresto bilaterale di posizione per evitare all'operatore contusioni o ferite per schiacciamento.
  - Snodo a doppia guida scorrevole regolabile in 7 punti per consentire un posizionamento preciso e sincronizzato. Perno passante per fornire un'esatta calibratura alla guida assicurando nel contempo una più elevata capacità di forza.
  - Centro di rotazione ottimale per ridurre notevolmente il dispendio di forze.
- 111 Forma ergonomica di ottima maneggevolezza  
 11 Impugnature forgiate e profilate con struttura antiscivolo per il massimo rendimento anche in difficili condizioni di lavoro.  
 • In acciaio al cromo vanadio con tempra ad alta resistenza.

**84853 PINZA REGOL. VBW 966-240 mm COU** Art. 0301 V079332 P/C.1



**Leghe Saldanti Per Brasatura Dolce  
Rame Ottone Bronzo  
Castolin**

## e>Listami-a BC 5423

### PROPRIETA' FISICHE E MECCANICHE

Intervallo di fusione (sol./Y13)	230-250°C
Dimensione del giunto	0,1-0,2 mm
Densità	7,3 Kg/dm <sup>3</sup>
Diametro	2,0 mm

**Lega in stagno puro per la saldatura di rame e ottone; indicato per uso alimentare e per impianti sanitari.**

**84874 BOBINA LEGA UNIV. § 2 GR250** CAS Art. 1515423BC20K P/C.1

## Castolin BC 8118

### PROPRIETA' PSICHE E MECCANICHE

Intervallo di fusione (sol./Iich)	221-240
Resistenza alla trazione R	100 N/miri
Resistenza al taglio	35/45 r4/mm
Densità	7,3 Kg/dm <sup>3</sup>
Diametro	2,0 mm

**Lega in stagno e argento.  
Scorrevolissima. Prodotto certificato per uso ospedaliero, farmaceutico e alimentare.  
Può saldare anche inox oltre a rame, ottone, bronzo ed accoppiamento misto.**

**84876 LEGA DOLCE CASTOLIN IN ROT cm** Art. LR8118BC20KP/C.1



## Cambiari DIS 8118

### CARATTERISTICHE

Intervallo di attività	150-450 C
Mettili' base	rame, leghe di rame, metalli fermai, max, leghe dr nickel
Dilinzin no	se necessario con acqua (max 1 Crr.)

**84879 DISOSSIDANTE x LEGA DOLCE** CAS Art. LR08118K1 P/C.1

**Leghe Saldanti Per Brasatura Forte  
Rame Ottone Bronzo  
Castolin**

## trya%tolin 8246

### PROPRIETA' FISICHE E M C

Intervallo di fusione (sotilici.)	715-805 c
Resistenza alla trazione FI	450 N/innY
temperatura dr h ivuru	720 C
pattuite	0,0 Kg/dm <sup>3</sup>
Dininutro	2 0-3,3 ipm

**per saldatura RAME RAME  
e RAME OTTONE  
(con disossidante 8110)**

**84882 BACCHETTA LEGA RAME/FOSF** CAS Art. LR8246RB20K P/C.1



## Castolin 8100 F

zpb9L.Szna4-111111-11NUAII;g14.1.49:11•1114

intervallo di fu. one (sul	810 790 C
assa tert•lorra• (I 950 W.mm	237 N: mm
	007K 10',.m
f	8 7 Kg, dm'
(f, .11.ets	1.5 2.0 rara

**Bacchetta 'rivestita' per brasatura forte su TUTTI I METALLI, anche per accoppiamento misto (escluso alluminio)  
Indicato nel settore condizionamento e passaggio gas.**

**84883 BAC-**

**CHETTA MEDIO/TEN AG 20%**

CASArt. LR8100RX15K P/C.1



## Castolin 8103 F

FMTin9~i1 2gifel,11 AI/7 WPITZ

Intervallo di fusione (sol./tici.)	595-630 C
Resistenza alla trazione R	480 N/mm'
Resistenza al taglio	195 N/mrn'
Resistivita	0.08 x 10•sim
Denente	9,3 Kg/dm'
Dtairtel"	mm

**Bacchetta "rivestita" per brasatura forte su TUTTI I METALLI. anche per accoppiamento misto (escluso alluminio)**

**Indicatissima per l'uso con basse temperature di fusione.**

84885 BACCHETT. ALTO TEN AG 40% GAS Art. LR8103RX15K2 PIC.1



## castilligt 8018 F

tmecimutTai MICH/ I mccuUfisCHE

bleu..1k> di komp.. I a y e	870-890°C
ik.k.11... I. 04a 14 ~5 • .0 54	480-490 N/mm'
T w.. le,APC M.. • , NIMALO II	880°C
i • • wiras	HB 110
.....ota	9.3 Kg/dm'

**Per tubi zincati e in ferro nero, ghisa, e saldobrasatura in genere. Indicata per tubi acqua, vapore e riscaldamento**

84884 BACCHETTA x SALDO-BRASATUR CASArt. LR8018F30K2 P/C.1



## castoun DIS 8110

Pasta ct' minar tpa'c0 ,ntlicato **iqnf'**  
tenore n'argento tipa 8103 8100 8110. 8

Consigliata anche itet leubs ' arme-ttish,i ,  
".TTIWimi<sup>u</sup>rr

Intervallo di attivita 550-900 C  
Diluizione sa necessario con acqua disUllata (max. 10%)

84878 DISSOLIDANTE SALDAT.FORTE CAS Art. LFID8110K1 P/C.1

### Elettrodi Scorrevoli Saldatura Ferro



**XuperiNOX**  
**2,5 mm 50-90 A**  
Elettrodo per la saldatura a contatto degli acciai dolci. Ideale per saldature d'angolo o brevi tratti con frequenti reinneschi.  
Caratteristiche meccaniche:  
Rm= 450-510 N/mm<sup>2</sup>  
Rs= 410 N/mm<sup>2</sup>  
A5=25-35%  
Resilienza (ISO-V) = 25J  
Durezza= 130-170HB  
Corrente: =(+) oppure —  
Saldatura con arco corto ed elettrodo quasi verticale. Per saldature d'angolo inclinare l'elettrodo nella direzione della saldatura mantenendo la punta a contatto col pezzo. Preriscaldamento non necessario.  
Funziona anche in condizioni di umidita.

84870 ELETTR. XUPER SCORREV. GAS Art. LRAUT025K12.4 KG/C.1

### Elettrodi Basici Saldatura Ferro



**TENACE**  
**o 2,5 mm 50-80 A**  
Elettrodo a rivestimento basico destinato alla saldatura degli acciai soggetti a forti sollecitazioni.  
Caratteristiche meccaniche:  
Rm= 510-570 N/mm<sup>2</sup>  
Rs= 430-470 N/mm<sup>2</sup>  
Resilienza (ISO-V) =120,1(20°C)  
Corrente: = (+) oppure -  
Saldatura con arco corto ed elettrodo quasi verticale. Evitare di oscillare l'elettrodo.  
Preriscaldamento non necessario.  
Funziona anche in condizioni di umidita.

84871 ELETTRODO TENACE CAS Art. LR521824K1 2.4 KG/C.1

## Elettrodi Saldatura Inox



**XuperINOX**  
 ø 2,0 mm 40-60 A  
 Elettrodo a rivestimento rutilico destinato alla saldatura degli acciai Inossidabili.  
 Massima resistenza alla corrosione. Ottima saldabilità.  
 Caratteristiche meccaniche:  
 Rm= 580N/mm<sup>2</sup>  
 Rs= 295 N/mm<sup>2</sup>  
 A5= 30%  
 Resilienza (150-11) = 32J (-120°C)  
 Norme AWS A5.4 E3161--17  
 Corrente: =(+) oppure  
 Saldatura con arco corto ed elettrodo quasi verticale.  
 Evitare di oscillare l'elettrodo.  
 Preriscaldamento non necessario.  
 Funziona anche in condizioni di umidità.

84872 ELETTR. XUPERINOX CAS Art. LR316L1720K1 2 KG/C.1

## Cannello Per Brasatura Forte Fino Al o 28 Composto Dal 4 Codici Seguenti



INDICATO PER  
 SALDATURA FORTE  
 E DOLCE

# KIT PROLINE

Cannello ad accensione rapida per saldatura  
 Materiale: Acciaio inossidabile  
 Impugnatura e Canna in alluminio anodizzato  
 La lancia è in acciaio inossidabile con un innesto in  
 di Saldatura  
 Condotto in PVC, con un peso netto di 1,1 kg e senza l'impiego  
 da accensione a mano. Una valvola di regolazione posta  
 sulla lancia, permette di regolare la fiamma in modo preciso.

- |                                  |                         |
|----------------------------------|-------------------------|
| 84887 CANNELLO PRO-LINE 4T       | CAS Art. LRPL4T P/C. 1  |
| 84888 REGOLAI. PER TL-4 PROLINE  | CAS Art. LRSTK-R P/C. 1 |
| 84889 MANICOTTO x TL-4 X PROLINE | CAS Art. LRST-12 P/C. 1 |
| 84892 BOMBOLA GAS MAPP           | CAS Art. LRBMAPP P/C.12 |

## Cannello Come Il Precedente Ma De Montare Direttamente Sulla Bombola Mapp



INDICATO PER  
 SALDATURA FORTE  
 E DOLCE

Cannello ad accensione rapida per saldare con qualsiasi  
 materiale  
 Suiadatto per l'impiego con GasTaco Mapp-Gas  
 E' dotato di comando rapido per l'accensione e per  
 disattivazione di sicurezza del cannello, di dispositivo di  
 miscelazione resistente ai ritorni di fiamma e  
 di dispositivo di impugnatura argonornica con protettiva  
 in PVC. E' dotato di dispositivo di serraggio erogazione gas per  
 lavori di lunga durata Riduce i tempi di saldature  
 a 30 Ha un ridotto consumo di gas circa 1/75 l/h

84890 CANNELLO TURBO LITE TL44 CAS Art. LR44 P/C. 1

## Kit Cannello Con Bombola Per Brasatura Dolce



ADATTO PER  
 TUTTI GLI STAGNI  
 PER BRASATURA DOLCE.

# Castulin TORCIA 1450

È un accendigas a rapida accensione in acciaio inossidabile  
 con lancia in ottone  
 da accensione a mano. Regolazione della potenza della fiamma  
 Lit. con una finitura di vernice di gas Butano  
 in acciaio inossidabile, priva di propellenti dannosi per l'ambiente  
 e con una capacità di 5 Pin litri. Contiene 600 ml di miscela e una  
 serie di accessori.  
 Il kit è composto da:  
 - Accendigas  
 - Bombola di gas  
 - Manicotto  
 - Regolatore  
 - Con lancia ad alto flusso  
 - Tiro al carbonio

84886 KIT CANN.C/BOMB.600ML 1450 CAS Art. LRNUOVOKIT1145D

84893 BOMBOLA PER KIT 1450 CAS Art. LARKITBOMB0450 P/C.12

**Macchina Elettrica Per Brasatura  
Dolce E Forte Rno A 018**



**DATI TECNICI**

**LECTRA (OMR)**



51. sOtI O A  
bleek~ 1.0.  
bader~s™ tecamier.  
OtWortervo ~Morro ~O

Periodo di garanzia per il grossfarmatere. 1() anni  
Prodotto garantito • 2 anni

84891 PINZA ELETT.LECTRA COM131 E RID Art. 27491 I P/C.1

84895 COP CARBONC x LECTRA COMBI RID Art. 73276 215LR P/C.1

84896 COP ELETR x LECTRA CILIN RID Art. 73286 260LR P/C.1

**Lega In Bacchette Per Brasatura Forte  
Banninger**



Composizione: Cu, P. °C 710-880

38974 LEGA GALAXY 230 BRAS.FORTE BAN Art. 4931 P/al

**Pasta Decapante Per Brasatura Dolce  
Caleffi**



**Gel decapante per la  
saldatura RAME con STAGNO.  
Con pennello incorporato nel tappo.  
Contenuto: 110 g  
NON contiene acidi.  
NON è corrosivo al rame.  
NON richiede pulitura delle parti da saldare.**

51770 DECAPANTE IN GEL x SALD RA CLF Art. 615100 P/C.100

**Pasta Decapante Per Brasatura Dolce  
Facot**



**NEW CUPREX**  
Autodecapante in pasta gelatinosa  
per tutti i lavori di stagnatura, con  
particolare riferimento a: rame, ottone,  
piombo, acciaio, ecc.  
Particolarmente indicato per: tubazioni,  
canali; grondaie, impianti elettrici, ecc.  
**Barattolo da 100 gr.**

54304 PASTA SALD NEW CUPREX 100g FAC Art. NEWCU100 P/C.1

**Pasta Decapante Per Brasatura Dolce  
Rhems**



84156 BARATT. PASTA CU 3 REMS COU Art. 0600RE07 P/C.1

**Pannetti Per La Pulizia Del Tubo  
Prima Della Saldatura**

**ROVLIES**

Reinigungsvelles zum Säubern von  
Kupferrohrenden Wa. Nr.04.5260

arowtoVosots.



84160 PANNETTILUCIDAT ROVLIES COU Art. 06000270 P/C.1

**Decapante In Pani Per Saldatura Stagno**

**STERESINA**

Acido stearico composto.  
Agente decapante per la saldatura  
delle canalizzazioni in piombo.  
**Pacchi da 1 kg.  
Confezioni da 100 gr.**



54307 STERESINA 100g PACCHI 1 kg FAC Art. STE010 P/C.1

**Stagno**

55000 STAGNO VERGINE VERGHE D-0 KG/CONF.20

55001 STAGNO VERGHE 50% D-0 KG/CONF.20

55003 STAGNO VERGHE 33% KG/CONF.20

**Piombo In Lastre**



**Altezza rotolo: 100 cm  
Spessori: da 1 a 3 mm**

10501 PIOMBO LASTRE 1 mm ZAN P/C.1

10502 PIOMBO LASTRE 1.5 mm ZAN P/C.1

10503 PIOMBO LASTRE 2 mm ZAN P/C.1

10504 PIOMBO LASTRE 3 mm ZAN P/C.1



**Cannelli Vari Per Saldatura Con Gas Gpl**



**26012 SALDAT. A CANNELLO 22mm** GNA Art. IS202 P/C.1



**26014 SALDAT. CON MAZZA RAME** GNA Art. SMR 170 P/C.1

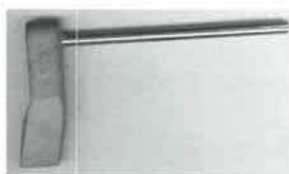

**26016 MAZZA RICAMBIO x SALDATORE** GNA Art. 01034 P/C.1



**26019 LANCIA A GAS C/LEV. 60 mm** GNA Art. IR 406 P/C.1



**26025 RACC.07".3 VIE GPL 8 MM** GNA Art. 270 P/C.1

**26028 RACC. x TUBO GAS x SALDAT.** GNA Art. 285 P/C.1



**26040 TUBO FLESSIBILE cm 50** GNA Art. 283/5 P/C.



**Il SET è confezionato in blister ed è composto da:**  
**Bruciatore in acciaio Ø 60 mm**  
**Prolunga • Lungh.: 600 mm**  
**Impugnatura con leva e filetto in entrata**  
**Tube di raccordo - Lungh.: 10 mt.**  
**Riduttore di pressione**

**26046 SET ASFALTISTA cm 60** GNA Art. IR/1206 TLR P/C.10

**Accessori Per Filettare Teflon**

**TEFLON LIQUIDO**



Sigillante anaerobico per filetti al P.T.F.E. per la tenuta stagna di filettature di impianti convoglianti liquidi alimentari, prodotti chimici, GPL, gas, ecc.  
 Tipo a svitamento morbido.  
 Tubetti da 100 gr.

**54337 TEFLON LIQUIDO 100 g** FAC Art. PTFE100 P/C.1



**Sigillante anaerobico a base P.T.F.E. per giunzioni filettate.**

Viene impiegato in sostituzione di canapa e nastro di P.T.F.E. Garantisce una perfetta tenuta con gas, gpl, aria compressa, acqua. Resiste alle vibrazioni, agli sbalzi termici, mantiene le proprietà sigillanti nel campo di temperatura da -55 a +150 gradi. La sigillatura è istantanea alle basse pressioni con filettature eseguite a norma. Garantisce anche dopo anni la facilità di smontaggio.

**55700 TEFLON LIQUIDO 100 g** MAN Art. 37280403 P/C.1

**55701 TEFLON LIQUIDO 250 g** MAN Art. 370104 P/C.1

**Ue**



**TEFLON**

Per accoppiamenti filettati in genere. Alta resistenza alla temperatura, agli agenti chimici e a quelli atmosferici. Disponibile nelle seguenti misure (lar x !un):  
**1/2 x 10 m 3/4 x 72 m 1 x 12 m**  
**7/2 x 50 m 3/4 x 50 m**

- 54311 TEFLON 1/2 x 12 MT** RoM Art. 224102012 P/C.12
- 54312 TEFLON 3/4 12 m PROFESS** FAC Art. TEFROT019 P/C.50
- 54313 TEFLON 1 12 m PROFESS** FAC Art. TEFROT025 P/C.50
- 54314 TEFLON 1/2 50 m PROFESS** FAC Art. TEFROT01250 P/C.50
- 54315 TEFLON 3/4 50 m PROFESS** FAC Art. TEFROT01950 P/C.50



54317 *IFLIONx VAPORE H12x13.7ml* FAC Art. TEFHD012 P/C.1



53901 *TEFLONx GAS 3/4 x 15 m* R-M Art. 224 P/C.50

**Nastro (Filo) Sigillante A Base Di Teflon**



**NASTRO SIGKLARACCORDI**  
**Loctite 55** è il nuovo, veloce, pratico sistema che vi farà dimenticare canapa e nastri di tenuta. Un sottile filo di teflon per tutte le vostre esigenze: idoneo per l'utilizzo con acqua calda e fredda e con gas. **Fiacone da 150 mt di filo**

21729 *NASTRO SIGIL LOCTITE55 150 LOC* Art. 710000 P/C.1

**Canapa**



**Canapa in Cargioli**  
Pettinato meccanico extra fine, idoneo a guarnire piccole, medie e grandi fil ettature.

53900 *CANAPA IN CARGIOLI* MQF Art. 00300010 P/C.1

**Pasta Verde Per Idraulica**



**SILICON**  
Mastice in pasta per il montaggio di apparecchi e raccordi idraulici, igienici, sanitari e industriali. Idoneo per: aria, acqua potabile, vapore, gas, ecc. Antiossidante, antigrippante inalterabile nel tempo. Temp. di esercizio: - 40 / + 140 gradi. **Barattolo da 500 gr.**

54301 *SILICON 0.500 kg* FAC Art. SIBA0.50 P/C.1



**KOLGAS**  
Mastice sigillante certificato, idoneo per la tenuta stagna di raccordi convoglianti gas. **KOLGAS** mantiene gli sfilacciati di canapa sempre morbidi ed inalterati nel tempo. **Adatto anche per aria, acqua e vapore.**

54302 *MASTICE x GAS KOLGAS* FAC Art. KOLGBA0.5 P/C.1

**Protezione Tubi Interrati**

**PARATEX**



Fascie paraffinose dielettriche autoadesive, per il rivestimento anticorrosivo e la protezione dalle correnti vaganti. Estrema facilità di posa. **Largh.: 10 cm**  
**Lungh.: 10 m**

54336 *PARATEX BENDA H 10 10 m* FAC Art. PAR10 P/C.16

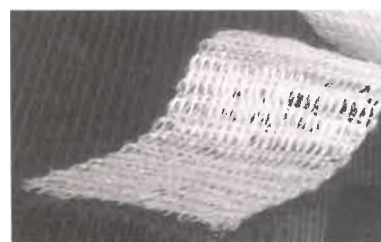

53915 *NASTRO VETROTES RETIC H 15* VIT P/C.1

**Disincrostanti Per Sanitari E Rubinetteria**



**Prodotto anticalcare in polvere indicato per la pulizia di rubinetti, soffioni e vasche.**

53920 *SOLVALINA 0.500 kg* SAB P/C.1



**CALNET SAN**

Anticalcare ecologico liquido, per sanitari. Efficace sulle superfici smaltate di: bagni, vasche, ceramica. Elimina residui organici e impurità.



54342 *ANTICALC x SANIT 500 ml* FAC Art. SAN05OSP P/C.1

54343 *ANTICALC x RUBIN 500 ml* FAC Art. BRIL050SP P/C.1





**Detergente e sgrassante** che prepara le superfici metalliche e non, prima di essere trattate con gli opportuni adesivi (GAS-SEAL, NEOGIT, etc.). Rimuove l'olio, il grasso ed altri agenti che renderebbero difficoltosa l'operazione di incollaggio e sigillatura su svariati materiali quali: metallo, vetro, gomma, ceramica, PVC, etc. E' indispensabile in officina per la pulizia e lo sgrassaggio di pezzi meccanici.

**DATI TECNICI**

Peso specifico: 0,647  
Solubilità in acqua: non solubile  
Pressione del contenitore (20 °C): 3,5 bar  
Prodotto infiammabile,

**54339** *PASSIVANTE CLEANx FILETTI* FAC Art. CLEAN400 P/C.1

**Disotturante Per Scarichi**



**FLOW**

**Disotturatore per scarichi e tubazioni.**  
Libera ogni tipo di occlusione e di intasamento generati da materiali organici. Trasforma in liquido tutti i depositi che creano le occlusioni. FLOW è una composizione a base acida inibita e tensioattivi combinati, Tale formulazione evita danni a tubazioni e guarnizioni in genere.  
**Flacone da 500 cl.**

**55768** *DISOTTUR. FLOW 0.5001* MAN Art. 292101 P/C.20

**Disotturente Per Scarichi A Pressione**



**UN ARTICOLO PROFESSIONALE ALLA PORTATA DI TUTTI**

in pochi secondi **eAr411,.04,,)** sblocca e pulisce tubazioni, lavabi, vasche da bagno, fognature, scarichi di ogni genere, sia parzialmente che completamente ostruiti, Ide2le per la casa, laboratori. Istituti, ospedali scuole, industrie ecc.

**71520** *STURALAVANDINO PANGO* P.O Art. 1002 P/C.1

*Lubrificanti Siliconici*



**SILIT Spray**

Olio siliconico spray multiuoso, Antiadesivo per saldature, lubrificante e protettivo contro la corrosione delle parti meccaniche in presenza di umidità. Prolunga la vita ad utensili taglienti. Rende durevoli nel tempo ed elastiche le parti in gomma e le guarnizioni.

**54300** *SILIT SPRAY GRASSO* FAC Art. SIL400 P/C.1



**SILIT**

Grasso siliconico idrorepellente per l'ingrassaggio di rubinetti, cuscinetti, pompe, compressori, valvole e parti a contatto con umidità.

**54303** *GRASSO PER ORING SILIT* FAC Art. SIL0.1 P/C.1

## Stucco Per Pilette

### KOBALSTUCCO

Stucco bianco per guarniture di pilette, vasche, lavabi, sanitari, w.c., ecc. Assolutamente impermeabile all'acqua. Barattolo da 1 kg.

54305 KOBALSTUCCO BARATTOLI 1 kg FAC Art. STUC P/C.1

## Stucco Per Scarichi Fumi

### MANGRAFIT



Stucco per la sigillatura di guarnizioni di impianti ad alta temperatura. Impiegato su caldaie, flange, ecc. Idoneo per alte pressioni di vapore, acqua bollente, gas caldi, soluzioni acide o alcaline, ecc. Barattolo da 1 kg.

54306 MANGRAFIT STUCCO CALD. 1kg FAC Art. MANG PIC.1

## Mastice Riparatore Per Perdite Non In Pressione



### EPOSTIX

Mastice epossidico bicomponente per la riparazione rapida di perdite. Per riparare: tubi sommersi, piscine, serbatoi, guarnizioni permanenti, in casa, auto, barca, roulotte. Ripara metalli, plastica, legno, ecc. Blister con barretta da 50 gr.

54308 EPOSTIX 50 g FAC Art. EP0050 P/C.1

## Nastro Alluminio Per Caldo E Freddo (Canali)



### NASTRO ADESIVO in Alluminio

Resistente alle alte temperature, per la finitura di impianti coibentati o di canalizzazione del termocondizionamento. Lungh. nastro: 50 mt. Largh. nastro: 50 mm./100 mm.

54310 NASTRO ADES.ALLUMINIO 5x50 FAC Art. NALU005

54318 NASTRO ADES.ALLUMINIO 10x50 FAC Art. NALU010

## Benda Per Segnalazione Tubi Gas e Acqua Negli Soavi

### NASTRO GIALLO GAS'

Nastro Giallo con scritta Nera  
Larg. banda: 9 cm  
Lungh. rotolo: 200 mt.

54330 BENDA ATTENZIONE GAS GIAL. FAC Art. GAS12E P/C.1



### BANDA BLU

## "ATTENZIONE TUBO ACQUA"

Nastro BLU con scritta nera.  
Larg. banda: 9 cm.  
Lungh. rotolo: 200 mt.

54331 BENDA ATTENZIONE ACQUA FAC Art. ACQUAEC2120



### MUSSOLE INAMIDATE

Bende di garza inamidata in cotone puro, per coibentazioni.

**Largh.: 10 cm**

**Lungh.: 10 m**

54332 MUSSOLA A MIDATA 10cm x 10m FAC Art. MUSA P/C.1



**COLORI DI RIFERIMENTO PER PORCELLANA E SEDILI COPRIWATER  
ANNO 2001**

**COLORI STANDARD**



**BIANCO  
EUROPEO**



**BIANCO  
IDEAL STANDARD**

**BIANCO  
DOLOMITE**

**BIANCO  
INGLESE**



**BIANCO  
VINCENTI**



**NERO**

**AGAIS  
SENESI**



**AZZURRO MALDIVE  
POZZI GINORI**



**AZZURRO SUSS  
VINCENTI**



**AZZURRO SUSS  
IDEAL STANDARD**



**CALIPSO  
POZZI GINORI**



**CALIPSO  
VINCENTI**



**VISONE  
IDEAL STANDARD**



**GRIGIO MAN.  
GINORI**



**GRIGIO SUSS  
IDEAL STANDARD**



**GRIGIO MAN.  
DOLOMITE**

**NATURA  
POZZI GINORI**

**PERGAMON  
DOLOMITE**

**PERGAMON  
POZZI GINORI**

**PERGAMON  
VINCENTI**

**ROSALBA  
CESAME**



**ROSA CINA  
DOLOMITE**



**ROSA ORIENTALE  
POZZI GINORI**



**ROSA SUSS  
IDEAL STANDARD**



**ROSA SUSS  
VINCENTI**

**VERDE SUSS  
IDEAL STANDARD**

**VERDE ACQUA COMP.  
DECORI**

**CHAMPAGNE  
POZZI GINORI**

**COLORI DI RIFERIMENTO PER PORCELLANA E SEDILI COPRIWATER  
ANNO 2001**

**COLORI OBSOLETI**



**AZZURRO**  
BERTOCCI



**BLU ARALDICO**  
POZZI GINORI IDEAL STANDARD



**BLU REGG.**  
IDEAL STANDARD



**BLU SIAM**  
CESAME



**BLU 72**  
CESAME



**BLU**  
BERTOCCI



**BLU MARINO**  
POZZI GINORI



**CACTUS**  
IDEAL STANDARD



**CASTORO**  
IDEAL STANDARD



**CELESTE**  
POZZI GINORI



**CELESTE**  
BERTOCCI



**DAINO**  
CESAME



**DUNA**  
IDEAL STANDARD



**FELCE**  
IDEAL STANDARD



**FONDALE**  
IDEAL STANDARD



**GIALLO MANCIU'**  
IDEAL STANDARD



**GIALLO**  
BERTOCCI



**GRIGIO**  
BERTOCCI



**GRIGIO**  
POZZI GINORI



**KASMIR**  
IDEAL STANDARD



**MARRONE**  
POZZI GINORI



**MELOGRANO**  
IDEAL STANDARD



**MIRTILLO**  
IDEAL STANDARD



**NOCE**  
POZZI GINORI



**OCRA**  
POZZI GINORI



**PRUGNA**  
POZZI GINORI



**ROSA AZALEA**  
POZZI GINORI



**ROSA CORALLINO**  
IDEAL STANDARD



**ROSA**  
BERTOCCI



**ROSSO**  
BERTOCCI



**TURCHESE**  
SCALA



**VANIGLIA**  
POZZI GINORI



**VERDE**  
BERTOCCI



**VERDE**  
POZZI GINORI



**VERDE**  
SCALA



**VERDE**  
VINCENTI



**VERDE MARE**  
IDEAL STANDARD



**VERDE SCOGLIERA**  
IDEAL STANDARD



**VERDE**  
GINORI



**VISONE**  
CESAME



**WHISKY**  
POZZI GINORI

**ELENCO CATEGORIE:**

**SANITARI PER MARCA  
E ACCESSORI PAG 1**

**SANITARI PER DISABILI PAG 50**

**RUBINETTERIA E RICAMBI PAG 64**

**RACCORDERIA CROMATA PAG 109**

**SIFONI PAG 115**

**CASSETTE DI SCARICO  
E RICAMBI PAG 140**

**ACCESSORI DA BAGNO PAG 169**

**LAVELLI E LAVATOI PAG 179**

**SCALDABAGNI E RICAMBI PAG 184**

**GRIGLIE DI VENTILAZIONE PAG 197**

**ABBEVERATOI PER STALLE PAG 202**

**IRRIGAZIONE  
PROFESSIONALE PAG 204**

**UTENSILERIA IDRAULICA PAG 214**

**NOTE**

*A pag.60-61-62 le vasche in metacrilato  
hanno le seguenti corrispondenze:*

*AMARANTE = ATLANTIC*

*CANOVA = CRETA*

*EGEA = AMACA = GOAL*

*GOCCIA = IONIA*

DESCRIZIONE	PAGINA	FORNITORE
-------------	--------	-----------

<b>ABBEVERATOI</b>		
VASCHETTA MURO ORIZZONTALE	202	FOR
VASCHETTA MURO VERTICALE	202	FOR
VASCHETTA NILO	202	BAS
VASCHETTA TUBO ORIZZONTALE	202	FOR
VASCHETTA TUBO VERTICALE	202	FOR
<b>ABBEVERATOI ACCESSORI</b>		
ASTINA PER P20-21-22-23	203	FOR
BUSSOLA CON TAPPO X P 20	202	FOR
CROCCETTA PER P20-21-22-23	203	FOR
DADO ASTINA P20-21-22-23	203	FOR
DADO REGISTRO PER P20	203	FOR
GUARNIZIONE IN GOMMA	203	FOR
MOLLA PER P20-21-22-23	203	FOR
NILO CODULI C/GIREL 1X1/2	202	BAS
NILO CODULI C/GIREL 1X3/4	202	BAS
NILO CROCERE	202	BAS
NILO GUARNIZIONI FIBRA 1	202	L-G
NILO GUARNIZIONI FIBRA 3/4	202	L-G
NILO GUARNIZIONI PARA GRAN	202	BAS
NILO GUARNIZIONI PARA PICC	202	BAS
NILO MOLLE	202	BAS
NILO PISTONC PNALV C/GUAR	202	BAS
NILO VITI REGISTRO	202	BAS
PALETTA P20-21-22-23	202	FOR
SPRUZZO P20-21-22-23	202	FOR
TAPPO IN GOMMA PIATTO	202	FOR
VALVOLA ABBEV AT INF 1X1/2	202	BAS
<b>ACCESSORI BAGNO IN CERAMICA DA INCOLLARE</b>		
PORTA BICCHIERE BIAN	169	C-L
PORTA BICCHIERE CHAM	169	C-L
PORTA BICCHIERE INCOL BIAN	170	C-L
PORTA BICCHIERE INCOL BIAN	170	C-L
PORTA CARTA BIAN	169	C-L
PORTA CARTA CHAM	169	C-L
PORTA CARTA INCOL BIAN	169	C-L
PORTA CARTA INCOL BIAN	170	C-L
PORTA SAP BIDET INCOL BIAN	169	C-L
PORTA SAP BIDET INCOL BIAN	170	C-L
PORTA SAP LAVAB INCOL BIAN	169	C-L
PORTA SAP LAVAB INCOL BIAN	170	C-L
PORTA SAP VASCA INCOL BIAN	170	C-L
PORTA SAP VASCA INCOL BIAN	170	C-L
PORTA SAPONE BIDET BIAN	169	C-L
PORTA SAPONE BIDET CHAM	169	C-L
PORTA SAPONE LAVABO BIAN	169	C-L
PORTA SAPONE LAVABO CHAM	169	C-L
PORTA SAPONE VASCA BIAN	169	C-L
PORTASCOPINO BRILLO BIAN	170	C-L
<b>ACCESSORI BAGNO IN PLASTICA CARRARA E MATTA</b>		
PORTA CARTA CHERSO BIAN	173	C-M
PORTA ROTOLO CRETA BIAN	173	C-M
PORTA SCOP. EGEO SET BIAN	173	C-M
PORTA SCOP. SPAZZOLO BIAN	173	C-M
PORTA SCOP. VERBANO BIANCO	173	C-M
PORTA SCOPINO ANTILLE BIAN	173	C-M
PORTA SCOPINO ISEO BIAN	173	C-M
SCOPINO ARNO BIAN	173	C-M
<b>ACCESSORI BAGNO IN PLASTICA METAFORM</b>		
ANGOLARE BIAN	171	MPL
APPENDIABITO TRIPLO BIAN	171	MPL
COP APPENDIABITI EVY BIAN	172	MPL
PORTA BICCHIERE BIAN	170	MPL
PORTA BICCHIERE EVY BIAN	172	MPL
PORTA OGGETTI ANG. 2P BIAN	171	MPL
PORTA ROTOLO EVY BIAN	172	MPL
PORTA ROTOLO APERTO BIAN	171	MPL
PORTA ROTOLO PENTA BIAN	172	MPL
PORTA SALV ANEL EVY BIAN	172	MPL
PORTA SALVIETTE 30 CM BIAN	171	MPL
PORTA SALVIETTE 60 CM BIAN	171	MPL
PORTA SALVIETTE EVY BIAN	172	MPL
PORTA SALVIETTE SNODO BIAN	171	MPL
PORTA SAPONE BIAN	170	MPL
PORTA SAPONE EVY BIAN	172	MPL
PORTA SAPONE CLIP APPOGGIO	171	MPL
PORTA SAPONE/SALVIET. BIAN	170	MPL
<b>ACCESSORI BAGNO INDA</b>		
CEST.P.SPUGNA/SAP COLOR.CR	177	IND
CESTINO AD ANGOLO BIAN	177	IND
CESTINO AD ANGOLO COLOR.CR	177	IND
CESTINO P.SPUGNA/SAP. BIAN	177	IND
MANIGLIONE FISSO 60 CM	178	IND
P.BICCHIERE COLORELLA BIA	176	IND

DESCRIZIONE	PAGINA FORNITORE
P.BICCHIERE COLORELLA CROM	176 ND
P.ROTOLO APERTO COLOR.BIAN	177 ND
P.ROTOLO APERTO COLOR.CROM	177 ND
P.ROTOLO CHIUSO EXPORT CR	178 ND
P.ROTOLO COLORELLA BIA	176 ND
P.ROTOLO COLORELLA CROM	176 ND
P.SALV.ANEL.COLORELLA BIA	176 ND
P.SALVIET.SNODO COLOR.CROM	176 ND
P.SALVIETTE 30 COLOREL.BIA	176 ND
P.SALVIETTE 30 EXPORT CROM	178 ND
P.SALVIETTE 45 COLOREL.BIA	176 ND
P.SALVIETTE 45 EXPORT CROM	178 ND
P.SALVIETTE 60 COLOREL. BI	176 ND
P.SALVIETTE ANEL.COLOR. CR	176 ND
P.SALVIETTE ANELLO EXP.CRO	178 ND
P.SALVIETTE COLOR.30 CM CR	176 ND
P.SALVIETTE COLOR.45 CM CR	176 ND
P.SALVIETTE COLOR.60 CM CR	176 ND
P.SALVIETTE SNODO EXP.CRO	178 ND
P.SALVIETTE SNODO COL. BIA	176 ND
P.SAPONE GESTINO EXPORT CR	178 ND
P.SAPONE COLOR.TRAS SUP CR	176 ND
PORTA ABITO 3 GANCI CROM	176 ND
PORTA ABITO COLORELLA BIA	177 ND
PORTA ABITO COLORELLA CROM	177 ND
PORTA OGG.ANG.2P TRIX BIAN	176 ND
PORTA SAPONE COLOR.SUP BIA	176 ND
PORTA SPUGNA/SAP A GESTINO	178 ND
SUPPORTO VASC/BICC SNETRO	177 ND
<b>ADATTATORE RAPIDO P/GOMMA PER AREATORI</b>	
ADATT.UNIVERS.RUBINXP/GOM	137 DNE
<b>AERATORI</b>	
AERATORE CON SNODO F	136 MAV
AERATORE CON SNODO M	136 MAV
AERATORE F 22X1 OTTONATO	136 EDR
AERATORE M 24X1 OTTONATO	136 EDR
AERATORE M 28X1 OTTONATO	136 EDR
AERATORE PAS/RID FRE 22X1	136 AMF
AERATORE PAS/RID FRE 24X1	136 AMF
AERATORE X LAV/BIDET M24X1	135 AMF
AERATORE X LAVELLO F 22X1	136 AMF
AERATORE X VASCA HFC 28 CR	136 AMF
CANNUCCIA C/MORS 15 CROM.	109 IPR
CANNUCCIA E AERATORE 15	109 IPR
SNODO C/DOCETTA E AERAT.	109 IPR
<b>ALA GOCCIOLANTE</b>	
ALA GOCCIOLANTE 16-30N	212 SRI
ALA GOCCIOLANTE 16-40N	212 SRI
ALA GOCCIOLANTE RT 50 M	212 IPR
<b>ANALIZZATORI DI COMBUSTIONE</b>	
ANALIZZATORE FUMI 325.1	217 TES
<b>ANELLI PER FINITURA TROPPOPIENO</b>	
ANELLO TR/P 020 CROMATO	36 DOL
ANELLO TR/P 020 DORATO	36 DOL
ANELLO TR/P 025 CROMATO	36 DOL
<b>ANEMOMETRI</b>	
ANEMOMETRO STICK 405	216 TES
<b>ANTICALCARE PER BAGNI</b>	
ANTICALC X RUBIN 500 ML	245 FAC
ANTICALC X SANIT 500 ML	245 FAC
<b>ASCIUGACAPPELLIA FOTOCPELLULA</b>	
ASCIUGACAP PICK-UP AUT BIA	54 DMP
<b>ASCIUGAMANI A FOTOCPELLULA</b>	
ASCIUGAMANI ELET TORNADO B	53 DMP
<b>ASSE PER LAVATOI</b>	
ASSA X LAVATOIO 60	183 PST
ASSA X LAVATOIO 75	183 DIW
ASSE IN LEGNO X LAVAT 60	183 DIW
<b>ATTACCHI BORDO VASCA GROHE</b>	
RACCORDO VERT	77 GRO
RACCORDO VERTICALE	77 GRO
<b>AUSILI PER DISABILI</b>	
BARRA FISSA RINF DES 60 CM	52 THE
BARRA FISSA RINF DES 83 CM	52 THE
BARRA FISSA RINF SIN 60 CM	52 THE
BARRA FISSA RINF SIN 83 CM	52 THE
BARRA RIBALT C/PORT CM83 B	52 THE
BARRA RIBALTABILE 60 CM	52 THE
BARRA RIBALTABILE 83 CM	52 THE
CORRIMANO ANG. X DOCCIA	51 THE
CORRIMANO VERTICALE 180 CM	53 THE
CORRIMANO VERTICALE 180 CM	53 THE
CURVA PROTEZIONE SIFONE	51 THE
PORTA CARTA IGENICA RINF.	53 THE

DESCRIZIONE	PAGINA FORNITORE
<b>BACINELLA EXPORT RICAMBIO</b>	
BACINELLA EXPORT PLAS.TRAS	178 IND
<b>BACINELLE PORTASAPONE</b>	
BACINELLA X COLOR/EXP TRAS	176 IND
<b>BANCHI DA LAVORO</b>	
BANCO LAVORO 107X75CM 1400	234 RID
<b>BATTERIA TIPO CATIS</b>	
BATTERIA X CASSETTA ALTA	143 TRE
<b>BATTERIE PNEUMATICHE PER CASSETTA IN CERAMICA</b>	
BATTERIA PNEUMATICA AZZURR	155 IDN
BATTERIA UNIBOX BASSO	156 ITS
BATTERIA UNIBOX ATT.LATERA	156 ITS
<b>BATTERIE PNEUMATICHE PER CASSETTA IN CERAMICA RICAMBI</b>	
CAMPANA UNIBOX	157 TS
CAPELLOTTO SOLLEVAM UNIB	157 TS
COMPLETO X CASS MONOBLOCCO	157 TS
COMPLETO X CASS SIFONIC	158 TS
CUPOLETTA PRESA ARIA	157 TS
GALLEGGIANTE POLISTIROLO	157 TS
GHIERA SERR. CAPELLOTTO	157 TS
GHIERA SERRAGGIO CASSETTA	157 TS
GRUPPO DI COMANDO	157 TS
LEVA DI BLOCCAGGIO	157 TS
MEMBRANA CHIUSURA X UNIBOX	157 TS
MOLLA INOX PULSANTE UNIBOX	157 TS
O-RING X PULSANTE COMANDO	157 TS
RACCORDO ATTACCO BASSO	157 TS
RUB.GALLEGG FLUID LATERALE	156 TS
RUB.GALLEGG.FLUID BASSO/TE	156 TS
RUBINETTO ARRESTO A SQUADR	157 TS
<b>BENDA AMIDATA PER RIPRISTINI VECCHI ISOLAMENTI</b>	
MUSSOLA AMIDATA 10CM X 10M	247 FAC
<b>BENDA PER RIPRISTINI INTERRATI</b>	
PARATEX BENDA H 10 10 M	245 FAC
<b>BENDA PER RIPRISTINI INTERRATI DA CATRAMARE</b>	
NASTRO VETROTES RETIC H 15	245 VIT
<b>BEVERINO REFRIGERATO PER COMUNITÀ</b>	
REFRIGERATORE FRESHBOX	158 ITS
<b>BEVERINO REFRIGERATO PER COMUNITÀ RICAMBI</b>	
CARTUCCIA RS-1SG X FRESHB	158 ITS
<b>BICCHIERE COLORELLA RICAMBIO</b>	
BICCHIERE X COLOR/EXP BIAN	176 IND
<b>BICCHIERE DA APPOGGIO</b>	
BICCHIERE APPOGGIO BIAN	176 IND
<b>BICCHIERE EXPORT RICAMBIO</b>	
BICCHIERE EXPORT PLAS.TRAS	177 IND
<b>BICONI CROMATI</b>	
385 BICONO F. CR 1/2X10	110 EDR
385 BICONO F. CR. 1/2X14	110 EDR
385 NIPPLES FEMMINA 1/2X12	110 EDR
385 NIPPLES FEMMINA 3/8X10	110 EDR
395 BICONO M. CR. 1/2X10	110 EDR
395 BICONO M. CR. 1/2X12	110 EDR
395 BICONO M. CR. 1/2X14	110 EDR
395 BICONO M. CR. 3/8X10	110 EDR
395 BICONO M. CR. 3/8X12	110 EDR
395 BICONO M. CR. 3/8X14	110 EDR
398 BICONO CROMATO 0 10	110 EDR
398 BICONO CROMATO 0 12	110 EDR
398 BICONO CROMATO 0 14	110 EDR
BICONO CURV 90° 10X10 CROM	110 TIR
<b>BOCCE DI EROGAZIONE</b>	
BOCCA EROGAZ PARETE SNODO	105 RVR
BOCCA EROGAZ X GR LAV RIVA	93 SOL
BOCCA EROGAZIONE 20 CM	109 CLB
BOCCA EROGAZIONE 25 CM	109 CLB
BOCCA EROGAZIONE 30 CM	109 MAV
BOCCA ORIENTABILE LAVABO	105 RVR
BOCCA ROVES CM 30 X GR LAV	109 MAV
BOCCA UNIVER. PER MONOFORO	109 CLB
CANNA A ELLE PER 5005	100 MPB
CANNA LAVELLO A U PER 5045	100 MPB
<b>BOCCE EROGAZIONE GROHE</b>	
BOCCA S 200 MM	76 GRO
BOCCA LAVABO 200 MM	76 GRO
BOCCA VASCA INC 140	76 GRO
<b>BORSA PER IDRAULICO</b>	
BORSA IDRAULICO 55X18	239 EUC
<b>BOX DOCCIA ECONOMICO</b>	
BOX DOCCIA 70/80 ANG. BIAN	59 FRG
<b>BOX DOCCIA NOVELLINI CRISTALLO</b>	
STAR FIS. 70 CR/PIU/BCO	58 NOV
STAR FIS. 75 CR/PIU/BCO	58 NOV
STAR FIS. 80 CR/PIU/BCO	58 NOV







DESCRIZIONE	PAGINA FORNITORE
-------------	------------------

STAR FIS. 90 CR/PIU/BCO	58 NOV
STAR LATO A 70 CR/PIU/BCO	56 NOV
STAR LATO A 75 CR/PIU/BCO	56 NOV
STAR LATO A 80 CR/PIU/BCO	56 NOV
STAR LATO A 90 CR/PIU/BCO	56 NOV
STAR SOF. 70 CR/PIU/BCO	57 NOV
STAR SOF. 75 CR/PIU/BCO	57 NOV
STAR SOF. 80 CR/PIU/BCO	57 NOV
STAR SOF. 90 CR/PIU/BCO	57 NOV
<b>BOX DOCCIA NOVELLINI METACRILATO</b>	
PETER 1-140X140 ACR/ANE/BI	58 NOV
STAR 2 P 102/108 AC/ANE/BI	57 NOV
STAR 2P 120 114/120 A/AN/B	57 NOV
STAR 2S 108 108/114 A/9010	57 NOV
STAR 2S 114 114/120 A/9010	57 NOV
STAR 3AN 100 96/102AN/9010	56 NOV
STAR 3ANT 70 66/72 AN/9010	56 NOV
STAR 3ANT 75 72/78 AN/9010	56 NOV
STAR 3ANT 80 78/84 AN/9010	56 NOV
STAR 3ANT 90 84/90 AN/9010	56 NOV
STAR 3ANT 95 90/96 AN/9010	56 NOV
STAR FISS 70 66/72 AN/9010	58 NOV
STAR FISS 75 72/78 AN/9010	58 NOV
STAR FISS 80 78/84 AN/9010	58 NOV
STAR FISS 90 84/90 AN/9010	58 NOV
STAR LAT A70 66/72 AN/9010	56 NOV
STAR LAT A75 72/78 AN/9010	56 NOV
STAR LAT A80 78/84 AN/9010	56 NOV
STAR LAT A90 84/90 AN/9010	56 NOV
STAR LATO DX R1 90 ACR/A/B	58 NOV
STAR LATO DX R3 80 ACR/A/B	58 NOV
STAR LATO SX R1 90 ACR/A/B	58 NOV
STAR LATO SX R3 80 ACR/A/B	58 NOV
STAR SOF 70 66/72 AN/9010	57 NOV
STAR SOF 75 72/78 AN/9010	57 NOV
STAR SOF 80 78/84 AN/9010	57 NOV
STAR SOF 90 84/90 AN/9010	57 NOV
STAR SOF 95 90/96 AN/9010	57 NOV
STAR SOF100 96/102 AN/9010	57 NOV
<b>BOX DOCCIA NOVELLINI RICAMBI</b>	
CON F.CUSC.+PAT.FANT.HAR.ST	59 NOV
CONF.CUSCI./PAT.FANT.HARM.	59 NOV
CONF.CUSCUPAT.FANT.SOFF.	59 NOV
CONF.CUSCI./PAT.STAR/FANTA	59 NOV
CONF.PATTINI RIC.HARM.STAR	59 NOV
CONF.RIC.PATTINI FAN/HA/ST	59 NOV
PROFILO A SCATTO X BOX ANG	59 NOV
PROFILO COMP.X PORT.20X40	59 NOV
PROFILO COMP.X PORT.40X40	59 NOV
<b>BRACCI DOCCIA</b>	
BRACCIO DOC C/SOF CLIZ CRO	168 IAS
BRACCIO DOC C/SOF TURB CRO	168 IAS
BRACCIO DOC ELITE PLUS CRO	166 VSN
BRACCIO DOCCIA PES. 1/2 M	166 COT
BRACCIO DOCCIA TONDO OT/CR	166 IAS
BRACCIO FUSO C/GOMMINO	166 COT
BRACCIO NORM. CROM. 20 CM	166 COT
BRACCIO NORM. CROM. 30 CM	166 COT
BRACCIO NORM. CROM. 40 CM	166 COT
NIPPLES X BR/DOC 1/2 MM	166 IAS
<b>CALIBRI</b>	
CALIBRO CORS.INOX 135 MM	239 IDH
CALIBRO CORS.INOX 153 MM	239 IDH
<b>CAMPANELLE PER PILETTONI</b>	
CAMPANELLA INOX LAVELLO	118 EDR
CAMPANELLA INOX VASCA	118 EDR
<b>CANAPA PER FILETTI</b>	
CANAPA IN CARGIOLI	245 MQF
<b>CANOTTI CROMATI</b>	
417 CANOTTO O/C 026 25 CM	115 EDR
417 CANOTTO O/C 026 100 CM	115 EDR
417 CANOTTO O/C 030 25 CM	115 EDR
417 CANOTTO O/C 030 100 CM	115 EDR
417 CANOTTO O/C 032 30 CM	115 EDR
417 CANOTTO O/C 032 100 CM	115 EDR
417/45 CANOTTO CAS ALTA 30	115 EDR
417B CANOTTO CART CR.26X25	115 EDR
417B CANOTTO CART CR.30X25	115 EDR
417B CANOTTO CART CR.32X25	115 EDR
417B CANOTTO CART CR.32X30	115 EDR
418 CANOTTO FLESS. 0 26X30	115 EDR
418 CANOTTO FLESS. 0 32X30	115 EDR
462 CANOTTO ECC C/ROS. 032	115 EDR
CANOTTO ECCENTRICO	115 CLB
CANOTTO FLESSIBILE 030X30	115 EDR

DESCRIZIONE	PAGINA FORNITORE
-------------	------------------

CANOTTO 026 C/D 1.1/4 30CM	115 MAV
CANOTTO X LAVATRICE CR 26	119 MAV
CANOTTO X LAVATRICE CR 32	119 MAV
PROLUNGA TELES OR/G 0 30	116 EDR
PROLUNGA TELES OR/G 026X14	116 EDR
PROLUNGA TELES OR/G 032X14	116 EDR
<b>CANOTTI IN PLASTICA PER SIFONI</b>	
CANOTTO ATT/LAVAT 40X1.1/2	125 EMU
CANOTTO ATT/LAVAT 40X40	125 EMU
<b>CAROTATRICI</b>	
CAROTATORE C/KIT HC2	229 RID
<b>CAROTATRICI ACCESSORI</b>	
KIT ASPIRAZIONE POLVERI	229 RID
PROLUNGA 300 MM	229 RID
SUPPORTO E PUNTA GUIDA 320	229 RID
SUPPORTO E PUNTO GUIDA 430	229 RID
<b>CARTA ASCIUGAMANI IN CONFEZIONI</b>	
ASCIUGAM.160 F.X DIST. 535	54 GSG
<b>CARTA ASCIUGAMANI IN ROTOLO</b>	
ROTOLO ASCIUGAMANI PER 519	55 GSG
<b>CARTA COPRIWATER</b>	
CARTA COPRIWATER PER 530	55 GSG
<b>CARTA IGENICA IN ROTOLI PER COMUNITA</b>	
ROT.IGIENICA MINIJUMBOCELL	54 GSG
<b>CARTUCCE IDEAL STANDARD CERAMIX</b>	
CARTUCCIA 4 GALLONI	81 IDE
CARTUCCIA 8 GALLONI	81 IDE
CARTUCCIA CPL 4 GALLONI	81 IDE
<b>CARTUCCE PER MIX AFRICA-COMO</b>	
CARTUCCIA 035 AFRIC-COMO	99 MPB
CARTUCCIA 035 AFRIC-COMO	99 MPB
<b>CARTUCCE PER MIX AUSTRALIA-BARI</b>	
CARTUCCIA 040 AUST-BARI	99 MPB
<b>CARTUCCE PER MIX BONOMIX</b>	
CARTUCCIA X BONOMIX	99 MPB
<b>CARTUCCE PER MIX EURODISC</b>	
CARTUCCIA EURODISC	76 GRO
<b>CARTUCCE PER MIX EUROMIX</b>	
CARTUCCIA TEFLON MIX	76 GRO
<b>CARTUCCE PER MIX HANSA</b>	
CARTUCCIA X MISCELATORE	100 HAN
<b>CARTUCCE PER MIX SOL</b>	
CARTUCCIA CER/GLOBO C/GHI	91 SOL
CARTUCCIA CER/GLOBO C/BIL	90 SOL
<b>CARTUCCE PER MIX SOL DOMUS</b>	
CARTUCCIA CER X MIX DOMUS	90 SOL
<b>CARTUCCE PER MIX VERSUS-VERONA</b>	
CARTUCCIA 040 VER	99 MPB
CARTUCCIA X VERONA GRIGIA	99 MPB
<b>CASSETTA SCARICO GEBERIT</b>	
CASSET EST 6/9 LT CHAMPAGN	152 GEB
CASSETTA ESTERNA BIAN	152 GEB
CASSETTA INCAS. L 10 C/TUB	152 GEB
CASSETTA PNEUM C/COP L 10	142 GEB
<b>CASSETTA SCARICO GEBERIT ACCESSORI</b>	
BATTERIA X CASSET UNIVERS	153 GEB
CAMPANA X CASS.110700	153 GEB
COMANDO MANUALE PNEUMATICO	153 GEB
PLACCA BIA. X 110700 2 COM	153 GEB
PLACCA BIANCA 1 COMANDO	152 GEB
PLACCA CROMOSAT. X 110700	153 GEB
ROSONE BIANCO 110	154 GEB
<b>CASSETTA SCARICO GEBERIT RICAMBI</b>	
CAMPANA C/BACIN X CASS 123	154 GEB
CAMPANA COMPL. TELESCOP.	154 GEB
CAMPANA COMPLETA X EUROSTA	154 GEB
GUARNIZ.CAMPANA DM 58X32	154 GEB
GUARNIZ.CAMPANA DM 63X23	154 GEB
GUARNIZ.CAMPANA DM 63X32	154 GEB
<b>CASSETTE DI RACCORDO PER GRIGLIE</b>	
RACC 100X100 QUAD XTOND100	199 EDP
RACC 140X140 QUAD XTOND100	199 EDP
<b>CASSETTE DI SCARICO KARIBA</b>	
CASS INC 9L C/PLACCNCANOT	144 KAR
CASSETTA KARIBA BIANCA	143 KAR
CASSETTA KARIBA LUX	144 KAR
CASSETTA KARIBA LUX PNEU	144 KAR
CASSETTA SUPER KARIBA BIAN	143 KAR
CASSETTA SUPER KARIBA CHAM	143 KAR
CASSETTA TOP DUO 0 40 BIAN	144 KAR
<b>CASSETTE DI SCARICO KARIBA RICAMBI</b>	
ANCORINA LUNGA SERIE 2001	146 KAR
ANELLO SLITTAMENTO	146 KAR
COPERC C/PULS X KAR 2001 B	146 KAR
COPERCHIO C/PULS LUX KARI	146 KAR



DESCRIZIONE	PAGINA FORNITORE
COPERCHIO C/PULS X SIKARIB	146 KAR
COPERCHIO X KARIBA 2005 BI	145 KAR
CURVA 90° C/ROS 032 CAS/AL	146 KAR
DADO CASSETTA KARIBA B	146 KAR
DADO X CASSETTA KARIBA 030	146 KAR
DADONE CANOTTO 032 C/GUARN	146 KAR
GRUP SOLLEV PNEU X CASS ES	146 KAR
GRUPPO FORCELLA	147 KAR
GRUPPO PISTONCINO GALLEGG	145 KAR
GUARN. VALV. SCAR. 78X20	146 KAR
GUARN. VALV. SCAR.60X23	146 KAR
GUARN.VALV SCAR TIPO NUOVO	147 KAR
GUARNIZIONE DADONE	146 KAR
GUARNIZIONE FONDO 60X19	146 KAR
LEVA COMANDO CASSETTA KAR	145 KAR
LEVA COMANDO S/KARIBA	145 KAR
LEVA X KARIBA	145 KAR
PLACCA NUOVA X CAS WC 9L	145 KAR
PLACCA X CAS WC 9L X365101	145 KAR
POLMONE ESPANSIONE PNEUMAT	146 KAR
PULSANTE-LEVA KAR/2005 BIA	145 KAR
TAPPO LATERALE X SUPERKAR	147 KAR
VALVOLA SCARICO TIPO NUOVO	147 KAR
<b>CASSETTE DI SCARICO OLIVER</b>	
CASS ALTA TURCHESE + RUB B	148 OLV
CASS MONOBLOC ZAFFIRO EST	148 OLV
CASSETTA HAVANA DUE	148 OLV
CASSETTA SMERALDO BIANCA	147 OLV
CASSETTA TOPAZIO BIANCA	147 OLV
CASSETTA TOPAZIO NEW98 BIA	147 OLV
CASSETTA ZAFFIRO 0 40 BIAN	148 OLV
<b>CASSETTE DI SCARICO OLIVER RICAMBI</b>	
ANCORINA PER CASS TURCHESE	149 OLV
KIT LEVA + PULL X TURCHESE	149 OLV
RUB GALLEG X TURCHESE 3/8	149 OLV
<b>CASSETTE IN CERAMICA DOLOMITE</b>	
CASSETTA CORTINA BIAN	36 DOL
<b>CASSETTE PER CONTATORI</b>	
CASS CONT RAME 40X30X25	201 FRR
CASS CONT RAME 50X40X25	201 FRR
CASS CONT ZIN STAGNA 40X60	201 FRR
CASSETTA CON INOX 30X40X25	201 FRR
CASSETTA CON INOX 50X40X25	201 FRR
CASSETTA CON INOX 60X40X25	201 FRR
CASSETTA CON INOX 60X45X25	201 FRR
CASSETTA CON INOX 60X50X25	201 FRR
CASSETTA CON ZINC 60X50X25	201 FRR
CASSETTA CONT ZIN 30X40X25	201 FRR
CASSETTA CONT ZIN 50X40X25	201 FRR
CASSETTA CONT ZIN 60X45X25	201 FRR
<b>CASSETTE PER CONTATORI ACCESSORI</b>	
CHIAVE X CASSETTA CONTATOR	201 FRR
SCHIENALE X CASS ZIN 40X50	201 FRR
SCHIENALE X CASS ZIN 45X60	201 FRR
<b>CASSETTE PLASTICA ALTE</b>	
CERVO CASS SIF/CAM/PUUGAL	142 GP
CERVO CASSETTA C/SIF-CAMP	142 GP
DAINO CASS SIF/CAM/PUL/GAL	142 GP
DAINO CASSETTA C/SIF-CAMP	142 GP
<b>CASSETTE PLASTICA ALTE RICAMBI</b>	
DAINO BUSTINA RICAMBI	142 GP
DAINO CAMPANA	142 GP
DAINO CONTRODADO	142 GP
DAINO LEVA C/PERNO	142 GP
DAINO LEVA C/PERNO NUOVO	142 GP
DAINO SIFONE	142 GP
<b>CASSETTE SCARICO AD ANGOLO</b>	
CASSETTA ANGOLO RENO PL B	149 FAI
<b>CASSETTE SCARICO DORA</b>	
CASSETTA DORA PLASTICA	149 FAI
<b>CASSETTE SCARICO PUCCI</b>	
CASSETTA PUCCI PLAST L 14	151 PUC
CASSETTA PUCCI RAME L 14	151 PUC
<b>CASSETTE SCARICO PUCCI ACCESSORI</b>	
CONF. PLAC/ROS/BOT/PROL BI	151 PUC
<b>CASSETTE SCARICO RICAMBI</b>	
FLAP PVC X BATTERIA	155 TIR
GUARNIZIONE SCODELL. 023	155 TIR
MEMBRANA X BATTERIA MON.	155 TIR
<b>CASSETTE SCARICO TAGO</b>	
CASSETTA TAGO PLAST ABS B	149 FAI
<b>CASSONI PORTAUTENSILI</b>	
CASSONE BASSO PORTAUT RS15	223 RID
COPPIA LUCCHETTI X CASSONE	223 RID

DESCRIZIONE	PAGINA FORNITORE
<b>CASTOLIN SALDATORI</b>	
CANNELLO TURBO LITE TL44	242 CAS
<b>CATENELLA PULL PER CASSETTE ALTE</b>	
PULL COMPLETO M 1.20 B	143 LEO
<b>CAVALLETTI IDRAULICO</b>	
BANCO CON MORSA A CATENA	233 RID
CAVALLETTO X IDRAULICO 2	227 FZA
CAVALLETTO X IDRAULICO 3	227 FZA
<b>CENTRALINE PER IRRIGAZIONE</b>	
CENTR.DP 2 STAZIONI ELETTR	209 SR
CENTR.DP 6 STAZIONI ELETTR	209 SR
CENTRAL. 4 STAZIONI IBRIDA	209 SR
CENTRAL. 6 STAZIONI IBRIDA	209 SR
CENTRAL. 8 STAZIONI IBRIDA	209 SR
CENTRAL.12 STAZIONI IBRIDA	209 SR
CENTRALINA AQUAPROGRAM	209 UN
PROGRAMM. AQUAUNO LOGICO	210 CLR
PROGRAMM. AQUAUNO PRATICO	210 CLR
PROGRAMM. AQUAUNO VIDEO 6	210 CLR
PROGRAMM. METEOCRITERIUM 6	211 CLR
PROGRAMM. METEOLAB 9	211 CLR
<b>CERNIERE PER SEDILI</b>	
CERN X SED QUAD/ALP CR COP	44 DOL
CERN X SED RIO/CLOD CR COP	44 DOL
CERNIERA X SED DISAB CROM	51 SNT
CERNIERE X SED MIKI COPPIA	48 DIN
COPPIA CERN. NUOVO JOLLY	48 FRG
COPPIA CERNIERE X CONCA	47 FRG
COPPIA CERNIERE X F/5 COMP	47 FRG
COPPIA CERNIERE X SED F9	47 FRG
KIT CERNIERE ATLANTICO	48 C-M
KIT CERNIERE S 12	48 C-M
SOLO VITI FISSAGG. JOLLY	48 FRG
COPPIA CERN.SED.CONCA	47 IDE
COPPIA CERN.SED.ELLISSE	47 IDE
COPPIA CERN.SED.LINDA-TESI	47 IDE
COPPIA CERN.SED.LIUTO	47 IDE
<b>CESAME SANITARI</b>	
BIDET 1F SINTESI BIAN	40 CSM
BIDET 3F ARETUSA BIAN	40 CSM
BIDET 3F B EPOQUE BIAN	41 CSM
CASSETTA B EPOQUE BIAN	41 CSM
COLONNA ARETUSA BIAN	40 CSM
COLONNA SINTESI BIAN	40 CSM
COLONNA X LAVABO 32X32	40 CSM
LAVABO 69 SINTESI BIAN	40 CSM
LAVABO ARETUSA BIAN	40 CSM
LAVABO B EPOQUE BIAN	40 CSM
SEDILE B EPOQUE BIAN	44 CSM
SEDILE SINTESI BIAN	44 CSM
VASO ARETUSA BIAN	40 CSM
VASO B EPOQUE S/PARETE BIA	41 CSM
VASO PARETE SINTESI BIAN	40 CSM
VASO SINTESI BIAN	40 CSM
BIDET 1F ARETUSA BIAN	40 CSM
<b>CESIOE PER TUBI IN PLASTICA</b>	
CESIOEXTUBO PLAST.027 1491	227 RID
CESIOEXTUBO PLAST.042 1492	227 RID
CESIOEXTUBO PLAST.060 1493	227 RID
LAMA X CESIOIA 1491 - 28 MM	227 RID
LAMA X CESIOIA 1492 - 42 MM	227 RID
PISTOLAXTUBO PLAST032 1435	227 RID
<b>CESTINO PORTA CARTA PER COMUNITÀ</b>	
CESTINO GETTACARTA BASCUL	55 GSG
CESTINO GETTACARTA S/COPER	55 GSG
<b>CHIAVE PER CODULI VALVOLE RADIATORI</b>	
CHIAVE UNIVERS A SCALINO	232 COU
CRICCO X CODULI MASTER	232 COU
<b>CHIAVE PER IDRANTINO PLASSON</b>	
CHIAVE X IDRANTINO	208 FIV
<b>CHIAVE PER PILETTE</b>	
CHIAVE X PILETTE DOPPIA M.	232 COU
<b>CHIAVI DINAMOMETRICHE</b>	
CHIAVE DINAMOM 180KG. 17	219 REC
CHIAVE DINAMOM 420KG. 22	219 REC
CHIAVE DINAMOM 550KG. 26	219 REC
CHIAVE DINAMOM 650KG. 29	219 REC
<b>CHIAVI PER IDRAULICO</b>	
CHIAVE X ATTACCHI 1017	231 RID
CHIAVE X INTERNI 342	231 RID
<b>CHIAVI PER PLASSON</b>	
CHIAVE FISSAX RACC 16/40	208 FIV
CHIAVE FISSAX RACC 40/75	208 FIV
CHIAVE FISSA X RACC 63/125	208 FIV

DESCRIZIONE	PAGINA	FORNITORE
<b>CHIAVI PER RADIATORE</b>		
CHIAVE RADIAT.500 MM 1	232	COU
CHIAVE RADIAT.500 MM 1.1/4	232	COU
CHIAVE RADIAT.750 MM 1	232	COU
CHIAVE RADIAT.750 MM 1.1/4	232	COU
LEVA CRICCO X RADIAT. 450	232	COU
<b>CILINDRO DI CARICA</b>		
DOS.CAR.CILINDRO K2 M	214	REC
<b>CODULI CON DADO PER PILETTE</b>		
DADO E CODULO CURVO 1.1/4	118	EDR
DADO E CODULO DRITTO 1.1/2	118	EDR
DADO E CODULO DRITTO 1.1/4	118	EDR
DADO E CODULO DRITTO DA 1	118	EDR
<b>COLLARI PER TUBO FUMO</b>		
COLLAR REG TUBI BIAN 8-14	200	MRV
<b>COLONNE SCARICO VASCA</b>		
COLONNA VASCA SALT/AUT	120	GEB
COLONNA SC C/EROGAZIONE CR	63	ITE
COLONNA SC S/EROGAZIONE CR	63	ITE
COLONNA VASCA AUT A SEDERE	122	EMU
COLONNA VASCA S/AUTOMATICO	122	EMU
COLONNA VASCA SEDILE SALT	120	GEB
PILETTA VASCA S C/T 1.1/4	118	GFB
<b>COLONNE SCARICO VASCA ACCESSORI</b>		
ACCESSORI SIFON VASCA BIA	120	GEB
ACCESSORI SIFON VASCA CROM	120	GEB
ACCESSORI SIFON VASCA DOR	120	GEB
SET FINITURE PIUSALT BIA	122	EMU
SET FINITURE PIL/SALT OTT	122	EMU
<b>CONGELATUBI</b>		
CONGELATORE ESKIMO 2	237	COU
CONGELATUBI SF-2100	235	RID
<b>CORONE DIAMANTATE</b>		
CORONA DIAM 0 102 MM	230	RID
CORONA DIAM 0 127 MM	230	RID
CORONA DIAM 0 152 MM	230	RID
CORONA DIAM 0 32 MM	230	RID
CORONA DIAM 0 42 MM	230	RID
CORONA DIAM 0 42 MM 30 CM	229	RID
CORONA DIAM 0 52 MM	230	RID
CORONA DIAM 0 52 NN 30 CM	229	RID
CORONA DIAM 0 56 MM	230	RID
CORONA DIAM 0 65 MM	230	RID
CORONA DIAM 0 65 MM 30 CM	229	RID
CORONA DIAM 0 82 MM	230	RID
CORONA DIAM 0 82 MM 30 CM	229	RID
CORONA DIAM 0102 MM 30 CM	229	RID
CORONA DIAM 0127 MM 30 CM	229	RID
CORONA DIAM 0152 MM 30 CM	229	RID
CORONA DIAMANT SEC 127 MM	230	RID
<b>CURVATUBI FERRO</b>		
CURVAT. IDRAUL.MAN. 2 3802	228	RID
<b>CURVATUBI RAME</b>		
CURVAT RAME AMICA 3 10-22	228	RVR
CURVATUBO MAN. RAME 8 MM	228	COU
CURVATUBO MAN. RAME 10 MM	228	COU
CURVATUBO MAN. RAME 12 MM	228	COU
CURVATUBO MAN. RAME 14 MM	228	COU
CURVATUBO MAN. RAME 16 MM	228	COU
PINZA X RAME EST. 6 MM	228	IDH
<b>CURVETTE MASCHIO MASCHIO PER SALISCENDI</b>		
PRESA ACQUA MM A TONDA CRO	160	IAS
RACCORDO EROG. DOCCIA CROM	160	GRO
RACCORDO EROG. DOCCIA LUC.	160	GRO
RACCORDO EROG. DOCCIA SAT.	160	GRO
RACCORDO EROGATORE BIANCO	160	GRO
<b>CURVETTE SOTTOLAVABO PER MISCELATORI</b>		
426 COPPIA CURV.MON.3/8X10	111	EDR
COP CURV SOT.C/LUNG 1/2X10	111	B-I
COPPIA CURVETTE 90° 1/2X10	110	B-I
COPPIA CURVETTE SOT.1/2X10	110	FRS
CURVET C/ROS 45°1/2X10 COP	110	VBE
CURVETTA A 45° CR 1/2X10	110	EDR
CURVETTA SOTTOLAV. 3/8X10	111	TIR
SQUADR.SOTTOLAV.1/2X12 CRO	111	EDR
SQUADR.SOTTOLAV.1/2X12 OTT	111	EDR
<b>DETERGENTE E SGRASSANTE PER FILETTI</b>		
PASSIVANTE CLEAN X FILETTI	246	FAC
<b>DISCHI DIAMANTATI</b>		
DISCO DIAMAN SEC 0115X22.2	230	RID
DISCO DIAMAN SEC 0230X22.2	230	RID
DISCO X GRAN SPIRAL 0 115	230	RID
DISCO X GRAN SPIRAL 0 230	230	RID
DISCO X PIASTR CERAM 0 115	230	RID

DESCRIZIONE	PAGINA	FORNITORE
<b>DISOTTURANTE PER SCARICHI</b>		
DISOTTUR. FLOW 0.500 L	246	MAN
<b>DISTRIBUTORE CARTA COPRIWATER</b>		
DISTRIBUT COPRIWATER MINI	55	GSG
<b>DISTRIBUTORE SACCHETTI IGENICI</b>		
DISTRIB.SACCHETTI IGENICI	55	GSG
<b>DISTRIBUTORI DI ASCIUGAMANI IN CARTA PER CONFEZIONI</b>		
DISTRIBUTORE ASCIUG CARTA	53	OND
DISTRIBUTORE ASCIUGAMANI	54	GSG
<b>DISTRIBUTORI DI ASCIUGAMANI IN CARTA PER ROTOLI</b>		
DISTRIBUTORE CARTA SPIRALE	55	GSG
<b>DISTRIBUTORI DI SAPONE LIQUIDO</b>		
DISTRIB SAP LIQ L11.2 INOX	54	GSG
DISTRIB. SAPONE QUICK BIAN	171	MPL
DISTRIBUTORE SAP LIQ L 0.5	55	GSG
DISTRIBUTORE SAP LIQ L 1.2	54	GSG
DISTRIBUTORE SAPONE LIQUID	53	OND
SPANDI SAPONE A PULSANTE	175	IND
<b>DISTRIBUTORI DI SAPONE LIQUIDO A FOTOCELLULA</b>		
DOSASAPONE MOEL	53	OND
<b>DOCCETTE</b>		
DOCCETTA C/PULSANTE BIANCA	158	MAV
DOCCETTA PESANTE BIANCA DR	165	COT
DOCCETTA TELEF C/ANEL CROM	165	MAV
DOCCIA DUPLEX LUSO NORM.	164	COT
DOCCIA NORMALE BIANCA	165	COT
DOCCIA PESANTE X DUPLEX B	164	COT
DOCCIA VENERE X DUPLEX B	164	COT
DOCCET BETA SOFT CLEAN CRO	165	VSN
DOCCET FLAVIA C/CURVA CRO	164	VSN
DOCCETTA ARDEA CRO	164	VSN
DOCCETTA ARDEA C/CURVA CRO	164	VSN
DOCCETTA BETA CRO	164	VSN
DOCCETTA DUOCLEAN 2 GETTI	165	SOL
DOCCETTA FLAVIA MAN/B CRO	165	VSN
DOCCETTA JET C/ANELLO NER	165	VSN
DOCCETTA NORDIN 3 GETTI CR	166	SOL
DOCCETTA ONDAPLUS 3 GET CR	165	SOL
DOCCIA STUDIO X MEGAMIX CR	99	MPB
<b>DOCCETTE ACCESSORI</b>		
GANCIO MURALE FIS OTT CRO	164	VSN
GANCIO MURO X DOCC OTT/CRO	164	MAV
PORTA FLES/DOC/BNASCA CRO	163	VSN
SUPPORTO FIS C/GANCIO CRO	164	VSN
SUPPORTO REGOLAB TOP CRO	159	VSN
<b>DOCCETTE CISAL</b>		
DOCCETTA NETTUNO CROM	166	CIS
DOCCETTA SIRIO CROMO/SAT	166	CIS
<b>DOCCETTE GROHE</b>		
DOCCETTA IDRO+NORMALE	163	GRO
DOCCETTA DOCCIA TOP 4 CR	163	GRO
DOCCETTA IDROSOFT+NORMALE	163	GRO
DOCCETTA RELEXA PLUS	163	GRO
DOCCETTA RELEXA PLUS CR/OR	163	GRO
DOCCETTA X DOC EUROPLUS BI	71	GRO
DOCCETTA X EUROPLUS GRI	71	GRO
DOCCETTA X LADYLUX BIANCA	75	GRO
DOCCETTA X MIX LAV EU-PLUS	71	GRO
DOCCIA X LADYLUX	75	GRO
<b>DOCCETTE GROHE ACCESSORI</b>		
SOSTEGNO DOCCIA MURO FISSO	159	GRO
SOSTEGNO DOCCIA MURO REGOL	159	GRO
<b>DOCCETTE ISA</b>		
DOCCIA CASCADE C/IDR BIA	165	AS
DOCCIA CURVA-JET C/IDR BIA	165	AS
DOCCIA CURVA-JET C/IDR CRO	165	AS
DOCCIA LIMPIDA BIANCA	165	AS
DOCCIA LIMPIDA CROMATA	165	AS
DOCCIA STAR MASS ACQUAP CR	166	AS
<b>DOCCETTE ISA ACCESSORI</b>		
SUPPORTO SNODO ATT/CON BIA	159	AS
SUPPORTO SNODO ATT/CON CRO	159	AS
SUPPORTO SNODO ATT/CON DOR	159	AS
<b>DOCCETTE RICAMBI</b>		
CURVA FISSA X DUPLEX	164	COT
SUPPORTO A BAIONET CON CR	159	FRS
SUPPORTO GIREVOLE CROMATO	159	FRS
SUPPORTO NORM. DUP TRI MUR	164	COT
<b>DOLOMITE SANITARI</b>		
COLONNA UNIVERSALE BIAN	28	DOL
FISSAG BIDET GARDA SOSPES	34	DOL
FISSAG SEMIC CLOD/GARD/R10	34	DOL
MENSOLA SUPP X LAV PETRA	30	DOL

DESCRIZIONE	PAGINA	FORNITORE	DESCRIZIONE	PAGINA	FORNITORE
<b>DOLOMITE SANITARI SERIE ALPINA</b>			ELETTROVALV FF REG/F 1.1/2	207	SRI
BIDET 1F ALPINA BIAN	28	DOL	ELETTROVALV FF REG/FLU 3/4	207	SRI
BIDET 3F ALPINA BIAN	28	DOL	ELETTROVALV FF REG/FLUS. 1	207	SRI
CASSETTA X QUA/ALPINA BIAN	28	DOL	ELETTROVALV MM 21-320M 1	207	SRI
LAVABO 65 ALPINA BIAN	28	DOL	ELETTROVALV MM 21-250 3/4	207	SRI
LAVABO SEMINC. ALPINA BIAN	28	DOL	<b>ESPANSORI PER RAME</b>		
VASO MONOBLOC. ALPINA BIAN	28	DOL	ESPANS. RAME TEST.12/18 D	228	RID
VASO PAVIMENTO ALPINA BIAN	28	DOL	<b>ESTRATTORI PER ARIA TEMPORIZZATI</b>		
<b>DOLOMITE SANITARI SERIE CLODIA</b>			ESTRAT.INC. C/SER 0120 T	199	TCH
BIDET 1F CLODIA BIAN	34	DOL	ESTRAT.INC.C/SERR 0 100 T.	199	TCH
BIDET 3F. CLODIA BIAN	34	DOL	<b>FILIERE BANCO ELETTRICHE</b>		
CASSETTA X MON.CLODIA BIAN	33	DOL	ALBERO TRASMIS. FILIER 844	226	RID
LAVABO 67 CLODIA BIAN	33	DOL	ANELLO FISSAG. FILIERA 758	226	RID
LAVABO SEMINC. CLODIA BIAN	33	DOL	FILIERA 300 COMP C/CAVALLE	225	RID
VASO MONOBL.CLODIA C/SED B	33	DOL	FILIERA MOD. 300AA C/TREP.	225	RID
VASO UNIV. CLODIA C/SED B	33	DOL	FILIERA UNIVER.2.1/2-4 141	226	RID
<b>DOLOMITE SANITARI SERIE GARDA</b>			<b>FILIERE BANCO ELETTRICHE RICAMBI</b>		
BIDET MON SOSP GARDA BIANC	34	DOL	TESTA RICAM.FIL 300 AUTOM.	226	RID
LAVABO 60 CM GARDA BIANCO	34	DOL	TUBETTO	226	RID
LAVABO 65 CM GARDA BIANCO	34	DOL	<b>FILIERE MANUALI</b>		
SEMICOLONNA GARDA BIANCO	34	DOL	FILIERA A CRICCO 3/8-1.1/4	224	RID
VASO SOSPEO GARDA BIANCO	34	DOL	FILIERA IDRAULICO IN VALIG	224	VLX
<b>DOLOMITE SANITARI SERIE PERLA</b>			<b>FILIERE PORTATILI ELETTRICHE</b>		
BIDET 1F PERLA BIAN	31	DOL	FILIERA PORT. FINO 2 690C	225	RID
BIDET 3F PERLA BIAN	31	DOL	FILIERA PORTATILE MOD.600C	224	RID
CASSETTA X PERUCORAL BIAN	31	DOL	<b>FLANGIATORI</b>		
COLONNA PERLA BIAN	31	DOL	FLANGIATORE 4/16 458MM	220	RID
LAVABO 60 PERLA BIAN	31	DOL	FLANGIATORE 6/16 345MM	220	RID
LAVABO 64 PERLA BIAN	31	DOL	FLANGIATORE 1/8-3/4 458	220	RID
VASO MONOBLOCCO PERLA BIAN	31	DOL	FLANGIATORE UNIV. 525-F	220	REC
VASO PARETE PERLA BIAN	31	DOL	FLANGIATORE X RAME 6-22 MM	220	REC
VASO PAVIMENTO PERLA BIAN	31	DOL	<b>FLESSIBILI DOCCIA</b>		
<b>DOLOMITE SANITARI SERIE PETRA</b>			FLESSIBILE 1.50 M OTTONE	100	MPB
BIDET 1F PETRA BIAN	31	DOL	FLESSIBILE 120 PLAST.CROMO	158	EMU
CASS MONOBL PETRA BIAN	30	DOL	FLESSIBILE 150 CONICO BIAN	159	CFX
COLONNA PETRA BIAN	30	DOL	FLESSIBILE 150 CONICO OTTO	159	CFX
LAVABO 90 PETRA BIAN	30	DOL	FLESSIBILE 150 PLAST.CROMO	158	EMU
LAVABO SEMIN PETRA BIAN	30	DOL	FLESSIBILE 200 CONICO BIAN	159	CFX
VASO MONOBL PETRA BIAN	30	DOL	FLESSIBILE 200 PLAST.CROMO	158	EMU
VASO UNIV PETRA BIAN	30	DOL	FLESSIBILE X DOCCIA 100 CM	158	COT
<b>DOLOMITE SANITARI SERIE RIO</b>			FLESSIBILE X DOCCIA 120 CM	158	COT
BIDET 1F RIO BIAN	29	DOL	FLESSIBILE X DOCCIA 150 CM	158	COT
BIDET 3F RIO BIAN	29	DOL	FLESSIBILE X DOCCIA 200 CM	158	COT
CASSETTA X 2224 RIO BIAN	29	DOL	FLEX DOC OT/CR D.GRAF 120	158	CFX
LAVABO 67 RIO BIAN	29	DOL	FLEX DOC OT/CR D.GRAF 150	158	CFX
LAVABO SEMINCASSO RIO BIAN	29	DOL	FLEX DOC OT/CR D.GRAF 200	158	CFX
VASO MONOBLOCCO RIO BIAN	29	DOL	<b>FLESSIBILI GROHE</b>		
VASO PAVIMENTO RIO BIAN	29	DOL	FLESS.DOCCIA 150 CM CR/ORO	159	GRO
<b>DOLOMITE SANITARI SERIE ZAGARA</b>			FLESSIB COMPL 700 MM EU-PL	76	GRO
BIDET 1F ZAGAR BIAN	32	DOL	FLESSIBILE 125 CM	159	GRO
CASSETTA MONOBL.ZAGAR BIAN	32	DOL	FLESSIBILE 150 CM	159	GRO
COLONNA ZAGAR BIAN	32	DOL	FLESSIBILE 200 CM	159	GRO
LAVABO 72 ZAGAR BIAN	32	DOL	<b>FLESSIBILI PER MISCELATORI</b>		
VASO ZAGAR BIAN	32	DOL	COPPIA FLEX 3/8F 10X1 BLIS	90	SOL
<b>DOLOMITE SANITARI ACCESSORI</b>			FLES INOX F3/8XM 8X1 CM.35	90	COT
SET TROPPO PIENO	36	DOL	FLESS C/PIOMBO X DOC/ESTR	90	SOL
<b>DOLOMITE SANITARI LAVABI INCASSO</b>			FLESSIBILE X MONOF 3/8X150	158	COT
LAVABO AGORDO SOTTOPIAN	35	DOL	<b>FONTANELLA IDEAL STANDARD</b>		
LAVABO INCASSO CLODIA BIAN	35	DOL	FONTANELLA FLAVIA 40 BIAN	20	IDE
LAVABO SELLA 58X45 BIAN	35	DOL	<b>FONTANELLA IDEAL STANDARD ACCESSORI</b>		
LAVABO SELLA 65X51 BIAN	35	DOL	GRUPPO FONTANELLA UNIVERS	20	TRE
LAVABO SEMINC. TOVEL BIAN	35	DOL	<b>FRESE PER RUBINETTI</b>		
<b>DOLOMITE SANITARI LAVABI SPECIALI</b>			FRESA PER RUBINETTI 3/8-1	239	COU
LAVABO BRIANZA 52X41 BIAN	35	DOL	FRESA RICAMBIO 1/2	239	IDH
LAVAMANI MADDAL.46X34 BIAN	35	DOL	<b>GALASSIA SANITARI</b>		
<b>ECCENTRICI CROMATI</b>			LAVABO SOTTOPIAN DENISE BIAN	24	GAL
ECCENTRICO 3/4X1/2 8 CM	113	EDR	<b>GALASSIA SANITARI SERIE ARKA</b>		
ECCENTRICO C/ROS CR3/8X3/4	113	EDR	LAVABO ARKE CONSOLLE 108DP	25	GAL
ECCENTRICO C/ROS. 1/2X3/4	113	EDR	BIDET MONOFORO ARKE	26	GAL
ECCENTRICO CR 1 CM 3/4X3/4	113	CLB	VASO MONOBL S/PAV OLA BIAN	25	GAL
ECCENTRICO CROMATO 1/2X40	113	EDR	VASO UNIVERSALE ARKE	26	GAL
RACC ECC OT/N MF1/2X1/2X20	113	TIR	<b>GALASSIA SANITARI SERIE OLA</b>		
RACC ECC OT/N MF1/2X1/2X30	113	TIR	BIDET MONO/TRIF OLA BIAN	25	GAL
RACC ECC OT/N MF1/2X1/2X40	113	TIR	CASSETTA MONOBL OLA BIAN	25	GAL
RACC ECC OT/N MF3/8X3/8X20	113	TIR	COLONNA OLA BIAN	24	GAL
RACC ECC OT/N MF3/8X3/8X30	113	TIR	LAVABO CM 60 OLA BIAN	24	GAL
RACC ECC OT/N MF3/8X3/8X40	113	TIR	VASO UNI PARETE OLA BIAN	25	GAL
<b>ELETTRODI CASTOLIN</b>			VASO UNI PAVIM OLA BIAN	25	GAL
ELETTRODO TENACE	241	CAS	<b>GALASSIA SANITARI ACCESSORI</b>		
ELETTRODO XUPER SCORREVOLE	241	CAS	PILETTA ARKE MANUALE	25	GAL
ELETTRODO XUPERINOX	242	CAS	SIFONE ARKE CILIND. 1.1/4	26	GAL
<b>ELETTROVALVOLE PER IRRIGAZIONE</b>			<b>GALLEGGIANTE PER CASSETTA GEBERIT</b>		
ELETTROV.PROGRAMMAB FF 1	207	CLR	RUBINETTO GALL COMPL 3/8	154	GEB
ELETTROV.PROGRAMMAB MM 3/4	208	CLR	RUBINETTO GALLEGG.X110700	154	GEB
ELETTROVALV FF 1.1/4	207	SRI	RUBINETTO GALLEGGIANTE	154	GEB



DESCRIZIONE PAGINA FORNITORE

<b>GALLEGGIANTE PER CASSETTA GROHE</b>		
VALVOLA CARICO	154	GRO
<b>GALLEGGIANTI</b>		
GALLEGG. SILENZ. INOX 1/2	140	S-T
GALLEGG. SILENZ. INOX 3/8	140	S-T
GALLEGGIANTE 5 COPP 2.1/2	140	S-T
GALLEGGIANTE 5 COPP PR 1/2	140	S-T
GALLEGGIANTE 5 COPP PR 3/4	140	S-T
GALLEGGIANTE 5 COPP PR 3/8	140	S-T
GALLEGGIANTE INOX 1	141	S-T
GALLEGGIANTE INOX 1.1/2	141	S-T
GALLEGGIANTE INOX 1.1/4	141	S-T
GALLEGGIANTE INOX 2	141	S-T
GALLEGGIANTE INOX 3/4	141	S-T
NOTTOLINO FIL 1/4 X SF RAM	141	S-T
<b>GALLEGGIANTI CASSETTE KARIBA</b>		
GALLEGG. UNIVERS.NORMA 3/8	145	KAR
<b>GALLEGGIANTI PER CASSETTA DORA</b>		
GALLEGGIANTE DORA	150	FAI
<b>GALLEGGIANTI PER CASSETTA PUCCI</b>		
GALLEGGIANTE COMPL T.NUOVO	151	PUC
GALLEGGIANTE COMPL. PUCCI	151	CLB
<b>GALLEGGIANTI PER CASSETTA RAMO</b>		
GALLEGGIANTE COMPL. RAMO	155	CLB
<b>GALLEGGIANTI PER CASSETTA STIR BLIZ</b>		
GALLEGGIANTE STIR-BLITZ	155	CLB
<b>GALLEGGIANTI PER CASSETTA TAGO</b>		
GALLEGGIANTE COMPLETO TAGO	149	FAI
<b>GALLEGGIANTI PER CASSETTE</b>		
GALLEGG AT/BASSO C/RUB 3/8	140	TIR
GALLEGGIANTE ATT/ALTO 3/8	140	TIR
GALLEGGIANTE ATT/BASSO 3/8.	140	TIR
RUB.GALLEG. AST/DEF-SF 3/8	140	TIR
<b>GANCI IN PLASTICA PER TENDE DOCCIA</b>		
GANCIO TENDA PLAST. BIANCO	174	IND
<b>GAS PER FRIGORISTI</b>		
AZOTO IND. BB	218	SLO
GAS ALGOFRENE R 22	218	SLO
GAS R410A MEFOREX	218	SLO
<b>GHIERE DI OTTONE DI RIDUZIONE</b>		
309 GHIERA OTTONE 1/2X3/4	112	EDR
309 GHIERA OTTONE 1X1.1/4	112	EDR
309 GHIERA OTTONE 3/4X1	112	EDR
GHIERA OTTONE 1/2X3/8	112	EDR
<b>GIRATUBI</b>		
CHIAVE BLITZ PKS DIR. 175	231	COU
CHIAVE BLITZ PKS DIR. 225	231	COU
CHIAVE BLITZ PKS DIR. 275	231	COU
CHIAVE PER ESAGONI SUPERAN	231	RID
GIRAT. DIR. ALL.1.1/2 810	232	RID
GIRAT. DIR. ALL.2 814	232	RID
GIRAT. DIR. ALL.2.1/2 818	232	RID
GIRATUB SVEDESE 45° 320	233	PAS
GIRATUB SVEDESE 45° 420	233	PAS
GIRATUB SVEDESE 45° 550	233	PAS
GIRATUB SVEDESE 90° 320	233	PAS
GIRATUB SVEDESE 90° 410	233	PAS
GIRATUB SVEDESE 90° 540	233	PAS
GIRATUB SVEDESE 90° 685	233	PAS
GIRATUB SVEDESE SAGOM.335	233	PAS
GIRATUB SVEDESE SAGOM.430	233	PAS
GIRATUB SVEDESE SAGOM.550	233	PAS
GIRATUBO 2 MANICI 2	232	RID
GIRATUBO DIRITTO 2 12	232	RID
GIRATUBO DIRITTO 2.1/5 18	232	RID
GIRATUBO DIRITTO 3 24	232	RID
GIRATUBO DIRITTO 5 36	232	RID
GIRATUBO DIRITTO 1.1/2 10	232	RID
GIRATUBO DIRITTO ALL.3 824	232	RID
GIRATUBO DIRITTO ALL.5 836	232	RID
GIRATUBO DIRITTO ALL.6 848	232	RID
GIRATUBO REGOL.90° 1.1/2	233	VEP
GIRATUBO REGOLAB 90° 1	233	VEP
GIRATUBO REGOLAB 90° 2	233	VEP
GIRATUBO SVEDESE MOD.110 3	233	IDH
GIRATUBO SVEDESE MOD.110 4	233	IDH
PINZA REGOL.VBW 966-240 MM	240	COU
GIRATUBO GANASCIA DR 1	233	SAN
GIRATUBO GANASCIA DR 1.1/2	233	SAN
GIRATUBO GANASCIA DR 2	233	SAN
GIRATUBO GANASCIA DR 3	233	SAN
GIRATUBO GANASCIA DR 4	233	SAN
<b>GIRATUBI A CATENA</b>		
GIRAT. A CATENA 110MM C-36	233	RID
GIRAT. A CATENA 50 MM C-12	233	RID

DESCRIZIONE PAGINA FORNITORE

GIRAT. A CATENA 50 MM C-14	233	RID
GIRAT. A CATENA 60 MM C-18	233	RID
GIRAT. A CATENA 75 MM C-24	233	RID
<b>GIRATUBI RICAMBI</b>		
GANASCE X 824	232	RID
GANASCE X 836	232	RID
GANASCE X 848	232	RID
GANASCINO C/PERNO X 824	232	RID
GANASCINO C/PERNO X 836	232	RID
GANASCINO C/PERNO X 848	232	RID
<b>GIRELLI PER RUBINETTI PORTA GOMMA</b>		
PORTAG/GIREL. X RUB SF. 1	131	ENO
PORTAG/GIREL. X RUB SF.112	131	ENO
PORTAG/GIREL. X RUB SF.314	131	ENO
PORTAG/GIREL. X RUB SF.3/8	131	ENO
<b>GRASSO PER ORING</b>		
GRASSO PER ORING SILIT	246	FAC
<b>GRASSO SILICONICO SPRAY</b>		
SILIT SPRAY GRASSO	246	FAC
<b>GRIGLIETTE CON SERRANDA</b>		
GRIGL.BRONZ C/SERR 135X135	199	EDP
GRIGL.BRONZ C/SERR 175X175	199	EDP
GRIGL.BRONZ C/SERR 178X115	199	EDP
<b>GRIGLIETTE DI AERAZIONE</b>		
GRIGL.ALL+RET TONDA 0135	197	EDP
GRIGL.ALL+RET TONDA 0175	197	EDP
GRIGL.C/RE/MOL TON 0135 RA	197	EDP
GRIGL.C/RE/MOL TON 0175 RA	197	EDP
GRIGL.C/RE/MOL TON 0235 RA	197	EDP
GRIGL.C/RETE RETT.183X154	197	EDP
GRIGL.C/RETE RETT.204X230	197	EDP
GRIGL.C/RETE TONDA 080-125	197	EDP
GRIGL.C/RETE TONDA0125-160	197	EDP
GRIGL.C/RETE TONDA0160-200	197	EDP
GRIGL.LAM+RET QUAD 140X140	199	EDP
GRIGL.LAM+RET RETT 240X140	199	EDP
GRIGL.LAM+RET RETT 340X140	199	EDP
GRIGL.RAM+RET INC 115X125T	197	EDP
GRIGL.RAM+RET INC 135X175T	197	EDP
GRIGL.RAM+RET INC 145X175T	197	EDP
GRIGL.RAM+RET INC 188X220T	197	EDP
GRIGL.RAM+RET INC T080-100	197	EDP
GRIGL.RAM+RET INC T095X110	197	EDP
GRIGL.RAM+RET QUAD 140X140	198	EDP
GRIGL.RAM+RET QUAD 240X240	198	EDP
GRIGL.RAM+RET RETT 140X240	198	EDP
GRIGL.RAM+RET RETT 240X140	198	EDP
GRIGL.RAM+RET RETT 340X140	198	EDP
GRIGL.RAM+RET TONDA 0135	197	EDP
GRIGL.RAM+RET TONDA 0175	197	EDP
GRIGL.RAME RETTANG 540X240	198	EDP
GRIGL.RET C/RE/MOL 500X227	198	EDP
GRIGL.RETT C/RETE 500X227	198	EDP
GRIGLIA PL QUADRA 230X230	198	EDP
GRIGLIA PL RET INC 200X150	198	EDP
GRIGLIA PL RET INC 370X130	198	EDP
<b>GRIGLIETTE INOX PER SCARICHI</b>		
GRIGLIETTA INOX	117	MAV
<b>GRUPPI DA LAVELLO A PARETE</b>		
GR LAVEL PAR CANNA/SUP CRO	94	EDR
GRUPPO LAVELLO NORMALE	94	EDR
<b>GRUPPI DA LAVELLO MONOFORO</b>		
GRUPPO MONOF LAVELLO SOLE	94	EDR
<b>GRUPPI MANOMETRICI</b>		
GR. MANOM.2VIE F2PF 80/A14	214	REC
MANOMETRO ALTA PRES X R22	214	REC
MANOMETRO BASSA PRES X R22	214	REC
<b>GUARNIZIONE PER TUBI FUMO 0 80</b>		
0-RING X SCAR/SDOPPIATO	191	ATI
<b>GUARNIZIONI</b>		
CONFEZ. GUARN.SANIT. ASSOR	138	CLB
CONFEZ.GUARN.ORING ASSORT.	138	CLB
CORDA AUTOADES PTFE 5X2X20	138	TIR
<b>GUARNIZIONI CONICHE</b>		
GUARNIZIONE CONICA 026	114	LEO
GUARNIZIONE CONICA 032	114	LEO
GUARNIZIONE CONICA 040	114	LEO
<b>GUARNIZIONI GOMMATE CON FILTRO</b>		
GUARN.CON FILTRO INOX 1/2	166	L-G
GUARN.CON FILTRO INOX 3/4	166	L-G
<b>GUARNIZIONI IN DUE PEZZI</b>		
GUARN 2PZ GOMMA CON 1	139	L-G
GUARN 2PZ GOMMA CON 1.1/2	139	L-G
GUARN 2PZ GOMMA CON 1.1/4	139	L-G
GUARN 2PZ GOMMA CON 1/2	139	L-G



DESCRIZIONE	PAGINA	FORNITORE	DESCRIZIONE	PAGINA	FORNITORE
GUARN 2PZ GOMMA CON 3/4	139	L-G	COLONNA IRIL BIAN	7	DE
<b>GUARNIZIONI IN GOMMA TELATE</b>			LAVABO IRIL 58 BIAN	7	DE
GUARNIZIONE GOM/TELA 1/2	138	LEO	LAVABO IRIL 65 BIAN	7	DE
GUARNIZIONE GOM/TELA 1	138	LEO	VASO IRIL PARETE BIAN	7	DE
GUARNIZIONE GOM/TELA 1.1/2	138	LEO	VASO IRIL PAVIMENTO BIAN	7	DE
GUARNIZIONE GOM/TELA 1.1/4	138	LEO	<b>IDEAL STANDARD SANITARI SERIE LINDA</b>		
GUARNIZIONE GOM/TELA 3/4	138	LEO	BIDET LINDA 1 FORO BIAN	3	DE
<b>GUARNIZIONI IN TRE PEZZI</b>			BIDET LINDA 3 FORI BIAN	3	DE
GUARNIZ 3PZ X PILET 1	139	LEO	CASSETTA X LINDA MON. BIAN	3	DE
GUARNIZ 3PZ X PILET 1.1/4	139	LEO	COLONNA LINDA BIAN	2	DE
GUARNIZ 3PZ X PILET 1/2	139	LEO	LAVABO LINDA 65 BIAN	2	DE
GUARNIZ 3PZ X PILET 3/4	139	LEO	LAVABO LINDA CM 60 BIAN	2	DE
<b>GUARNIZIONI PER RUBINETTI</b>			VASO LINDA MONOBLOCCO BIAN	3	DE
GUARN GOM SED/RUB FOR 1/2	138	LEO	VASO LINDA PAVIMENTO BIAN	2	DE
GUARN GOM SED/RUB FOR 3/4	138	LEO	<b>IDEAL STANDARD SANITARI SERIE LIUTO</b>		
GUARN GOM SED/RUB FOR 3/8	138	LEO	BIDET LIUTO 1 FORO BIAN	4	DE
GUARN GOM SED/RUB FORAT 1	138	L-G	BIDET LIUTO 3 FORI BIAN	4	DE
GUARNIZ TENAX X RUBIN 1	139	TIR	CASSETTA X LIUTO BIANCA	4	DE
GUARNIZ TENAX X RUBIN 1/2	139	LEO	LAVABO LIUTO 64 BIAN	3	DE
GUARNIZ TENAX X RUBIN 3/4	139	LEO	LAVABO LIUTO 70 BIAN	3	DE
GUARNIZ TENAX X RUBIN 3/8	139	LEO	VASO LIUTO MONOBL PAR BIAN	4	DE
<b>GUARNIZIONI SENZA AMIANTO</b>			VASO LIUTO MONOBLOCCO BIAN	4	DE
GUARNIZ S/AM X RA OT 1.1/2	138	L-G	VASO LIUTO PAVIMENTO BIAN	3	DE
GUARNIZ S/AM X RA OT 1.1/4	138	L-G	<b>IDEAL STANDARD SANITARI SERIE SMALL</b>		
GUARNIZ S/AM X RA OT 2	138	L-G	BIDET 1/F SMALL BIAN	16	DE
GUARNIZ S/AM X RACC OT 1	138	L-G	LAVABO AN DX SMALL BIA MON	15	DE
GUARNIZ S/AM X RACC OT 1/2	138	L-G	LAVABO AN SX SMALL BIA MON	15	DE
GUARNIZ S/AM X RACC OT 1/4	138	L-G	LAVABO CENTRALE SMALL BIA	14	DE
GUARNIZ S/AM X RACC OT 3/4	138	L-G	SEMICOLONNA X LAV. SMALL BI	15	DE
GUARNIZ S/AM X RACC OT 3/8	138	L-G	VASO PARETE SMALL BIA	15	DE
<b>IDEAL STANDARD SANITARI</b>			VASO PAVIMENTO SMALL BIAN	15	DE
CASS ZAINO C/COP/BAT BIAN	6	DE	VASO SOSP. PAR SMALL BIAN	16	DE
COLONNA LIUTO/TESI BIAN	8	DE	BIDET SOSP. 1F SMALL BIAN	16	DE
<b>IDEAL STANDARD SANITARI SERIE ALA</b>			<b>IDEAL STANDARD SANITARI SERIE TESI</b>		
BIDET ALA 1 FORO BIAN	10	DE	BIDET 1F. SOSP. NUO TESI BIA	9	DE
LAVABO ALA SOSPESA 70 BIAN	9	DE	BIDET TESI 1 FORO BIAN	9	DE
SEMICOLONNA ALA SOSP BIAN	9	DE	BIDET TESI 3 FORI BIAN	9	DE
VASO ALA BIAN	10	DE	CASSETTA X 3037 TESI BIAN	8	DE
<b>IDEAL STANDARD SANITARI SERIE CALLA</b>			LAVABO TESI 65 BIAN	8	DE
BIDET 1F CALLA BIANCO	11	DE	LAVABO TESI 70 BIAN	8	DE
BIDET 3F CALLA BIANCO	11	DE	VASO SOSP. NUO. TESI BIA	9	DE
CASSETTA C/COP BAT CALLA B	11	DE	VASO TESI MONOBLOCCO BIAN	8	DE
COLONNA CALLA BIAN	10	DE	VASO TESI PARETE BIAN	8	DE
LAVABO CALLA 68 BIAN	10	DE	VASO TESI PAVIMENTO BIAN	8	DE
LAVABO SEMINC CALLA BIANCO	10	DE	<b>IDEAL STANDARD SANITARI SERIE VERBA</b>		
VASO C/SEDILE CALLA BIAN	11	DE	BIDET VERBA 1 FORO BIAN	6	DE
VASO MONOB C/SED CALLA BIA	11	DE	LAVABO 1F VERBA 65X54 BIAN	5	DE
<b>IDEAL STANDARD SANITARI SERIE CONCA</b>			SEMICOLONNA VERBA BIAN	5	DE
BIDET CONCA 1 FORO BIAN	2	DE	VASO VERBA PAVIMENTO BIAN	6	DE
BIDET CONCA 3 FORI BIAN	2	DE	<b>IDEAL STANDARD SANITARI LAVABI INCASSO</b>		
CASSETTA X CONCA MON. BIAN	1	DE	LAVAB VANITORY INCAS. BIAN	17	DE
COLONNA CONCA BIAN	1	DE	LAVABO INCASSO SOTTOQ BIAN	17	DE
LAVABO CONCA 65 BIAN	1	DE	LAVABO SEMINC. UNIV. BIAN	16	DE
LAVABO CONCA 70 BIAN	1	DE	LAVABO SOTT/OVALE BIAN	16	DE
LAVABO SEMINC. CONCA BIAN	1	DE	<b>DRANTINO PLASSON</b>		
VASO CONCA MONOBLOCCO BIAN	1	DE	DRANTINO M 3/4	208	FIV
VASO CONCA PAVIMENTO BIAN	1	DE	<b>DRANTINO PLASSON RICAMBI</b>		
VASO CONCA SC/PARETE BIAN	2	DE	COPERCHIO X IDRANTINO GIAL	208	FIV
<b>IDEAL STANDARD SANITARI SERIE ELISSE</b>			<b>GROMETRO</b>		
BIDET ELISSE 1 FORO BIAN	5	DE	GROMETRO STICK STELO 605	216	TES
COLONNA ELISSE BIAN	4	DE	<b>RRIGATORI A BATTENTE</b>		
LAVABO ELISSE 61 BIAN	4	DE	BETA GARDEN IRRIG M 1/2	204	IPR
LAVABO ELISSE 68 BIAN	4	DE	RRIGATORE FILET F 1	204	IPR
VASO ELISSE PAVIMENTO BIAN	5	DE	RRIGATORE FILET F 1.1/4	204	IPR
<b>IDEAL STANDARD SANITARI SERIE ESEDRA</b>			RRIGATORE FILET F 3/4	204	IPR
BIDET ESEDRA 1F BIAN	13	DE	RRIGATORE IMPACT PICCHET.	204	CLR
CASSETTA X ESEDRA MON. BIAN	12	DE	<b>RRIGATORI A BATTENTE RICAMBI</b>		
COLONNA ESEDRA BIAN	12	DE	UGELLO X IRRIGAT 2624 0 4	204	IPR
LAVABO ESEDRA 63 BIAN	12	DE	UGELLO X IRRIGAT 2624 04.5	204	IPR
LAVABO ESEDRA 68 BIAN	12	DE	UGELLO X IRRIGAT 2624 05.5	204	IPR
VASO ESEDRA MONOBLOC BIAN	12	DE	<b>IRRIGAZIONE IMPIANTI</b>		
VASO ESEDRA PARETE BIAN	12	DE	BANDIERINA PICCHETTO 6805	204	SR
VASO ESEDRA PAVIMENTO BIAN	12	DE	BOCCHETTONE PLAST 3/4	208	SR
<b>IDEAL STANDARD SANITARI SERIE FIORILE</b>			CONNETTORE CAVI/E T/STAGNA	207	SR
BIDET FIORILE 1F BIAN	14	DE	FILTRO LINEAAY 1.1/2	208	SR
BIDET SOSP. 1/F FIORILE BIA	14	DE	FILTRO LINEAAY 1.1/4	208	SR
COLONNA FIORILE BIAN	13	DE	FILTRO LINEA IN POLIET 1	208	SR
LAVABO FIORILE 65 BIAN	13	DE	FUSTELLA FORATUBO	213	UN
LAVABO FIORILE 70 BIAN	13	DE	GOCCIOLAT REGOLAB DRIP-ADJ	213	SR
LAVABO SEMINC. FIORILE BIAN	13	DE	GOCCIOLAT SU ASTINA 360°	213	SR
VASO FIORILE PAVIMEN BIAN	13	DE	GOCCIOLATORE AUTOCOMP RA-4	213	SR
VASO SOSP. C/SED. FIORILE BI	14	DE	GOCCIOLATORE NORMALE RN-4	213	SR
<b>IDEAL STANDARD SANITARI SERIE IRIL</b>			GOMITO CON BOCCHETTONI 1	208	SR
BIDET IRIL 1 FORO BIAN	7	DE	GOMITO P/GOMMA 90° 0 16	212	SR
BIDET IRIL 3 FORI BIAN	7	DE	GOMITO P/GOMMA 90° 0 20	212	SR



DESCRIZIONE	PAGINA FORNITORE
NNESTO DIRITTO 4 MM RSP4	212 SR
RRIG STAT SRS-04 H100 HUN	205 SR
RRIG.PERC.30-360° NELSON	204 SR
RRIGAT STAT SRS-02 H 50	205 SR
RRIGAT STAT SRS-06 H 150	205 SR
RRIGATORE TURB. PGP-ADJ	205 SR
RRIGATORE TURBINA PGM-04	205 SR
RRIGATORE TURBINA PGM-06	205 SR
MANICOTTO P/GOMMA 0 16	212 SR
MANICOTTO P/GOMMA 0 20	212 SR
MICRONEB.JSF360 0 2.4 M	213 SR
MICRONEB.JSH180 RAG.1.2 M	213 SR
MICRONEB.JSQ90 RAG.1.8 M	213 SR
MICRONEB.VJ180 RAG.0-3.2 M	213 SR
MICRONEB.VJ360 0 0-8 M	213 SR
MICRONEB.VJ90 RAG.0-3.2 M	213 SR
MICROTUBO 4 X 7 MM STV470	212 SR
NIPPOLO X DUE COLLETT MF 1	208 SR
PICCHETTO PA40	212 SR
PORTAGOM X TUBO 1/2 FIL3/4	213 UN
PORTAGOM X TUBO 1/4 FIL3/4	213 UN
POZZETTO 0 18 X H23 TONDO	208 SR
PROLUNGA SEG AT 1/2MX1/2M	207 SR
PROLUNGA SEG AT 3/4MX1/2M	207 SR
PROLUNGA SEG AT 3/4MX3/4M	207 SR
PROLUNGA TELESCOPICA 1/2	207 UN
PROLUNGA TELESCOPICA SH-22	207 SR
RACCORDO FILM 16X1/2	212 SR
RACCORDO FIL M 20X1/2	212 SR
REGOLATORE PRESS PRE-TARAT	208 SR
RICAMBIO X FILTRO 3032	208 SR
TAPPO FINE LINEA 114A 0 16	212 SR
TAPPO FINE LINEA 114A 0 20	212 SR
TE 90° DERIV.M 16X3/4X16	212 SR
TEE CON DUE BOCCHETT 1	208 SR
TEE P/GOMMA 0 16	212 SR
TEE P/GOMMA 0 20	212 SR
TESTIN SOTTOS PL N12T 120°	206 SR
TESTIN SOTTOST N12-H 180°	206 SR
TESTIN SOTTOST N12-0 90°	206 SR
TESTIN SOTTOST N12-TQ 270°	206 SR
TESTINA PL N10LA-F A 360°	206 SR
TESTINA PL N10LA-H A 180°	206 SR
TESTINA PL N10LA-Q A 90°	206 SR
TESTINA PL N8FLT-H 180°	206 SR
TESTINA PL N8FLT-Q 90°	206 SR
TESTINA PL S-10A 25-360°	207 SR
TESTINA PL S-12A 25-360°	207 SR
TESTINA PL S-17A 25-360°	207 SR
TESTINA PL. SS-530	206 SR
TESTINA PL. LCS-515	206 SR
TESTINA PL. RCS-515	206 SR
TESTINA PL.N12-F 360°	206 SR
TESTINA STAND N15-CST C/ST	206 SR
TESTINA STAND N15-EST TERM	206 SR
TESTINA STAND N15-F 360°	205 SR
TESTINA STAND N15-H 180°	205 SR
TESTINA STAND N15-Q 90°	205 SR
TESTINA STAND N15-SQ QUADR	206 SR
TESTINA STAND N15-SST LATE	206 SR
TESTINA STAND N15-TO 270°	205 SR
VALVOLA DI DRENAGGIO 1/2	208 SR
VALVOLA DI DRENAGGIO 3/4	208 SR
<b>LAME PER SEGHETTI</b>	
LAMAXSEGHETTO ALT. 2 D1004	234 RID
LAMAXSEGHETTO ALT. 4 D1005	234 RID
<b>LAUFEN SANITARI</b>	
BIDET SOSPESO VIENNA BIA	21 LAU
LAVABO VIENNA CM 65 BIA	21 LAU
PALACE LAVABO CONSOLE 120	21 LAU
SEMICOLONNA VIENNA BIA	21 LAU
VASO SOSPESO VIENNA BIA	21 LAU
<b>LAUFEN SANITARI ACCESSORI</b>	
PALACE GRIGLIA CROMO	22 LAU
<b>LAVABO AD ANGOLO IDEAL STANDARD</b>	
LAVABO ANG SALARIA 43 BIAN	19 IDE
<b>LAVAPIEDI CERAMICA DOLOMITE</b>	
LAVAPIEDI ROMANIA BIAN	36 DOL
<b>LAVATOI A CANALE CERAMICA GALASSIA</b>	
LAVATOIO CANALE 120 BIAN	23 GAL
LAVATOIO CANALE 90 BIAN	23 GAL
<b>LAVATOI CERAMICA DOLOMITE</b>	
COP. PIEDINI X MESSICO DUE	38 DOL
LAVATOIO MESSICO 75	38 DOL
LAVATOIO MESSICO DUE 60	38 DOL

DESCRIZIONE	PAGINA FORNITORE
LAVATOIO PERU 60X46	38 DOL
LAVATOIO PERU 61X61	38 DOL
LAVELLO PERSIA 42	38 DOL
LAVELLO VIRGINIA 60	38 DOL
LAVATOIO ISIDE 60 BIAN	23 GAL
LAVATOIO ISIDE 75 BIAN	23 GAL
<b>LAVELLI CUCINA CERAMICA DOLOMITE</b>	
LAVELLO ARNO 120 DESTRO	37 DOL
LAVELLO ARNO 120 SINISTRO	37 DOL
LAVELLO ARNO T/FR DESTRO	37 DOL
LAVELLO ARNO T/FR SINISTRO	37 DOL
LAVELLO BRASILE 120	37 DOL
LAVELLO CANADA 100	37 DOL
LAVELLO CANADA 80	37 DOL
LAVELLO CANADA 90	37 DOL
LAVELLO PANAMA 100X45	37 DOL
LAVELLO PANAMA 80X45	37 DOL
LAVELLO PANAMA 90X45	37 DOL
LAVELLO TURCHIA 100 DESTRO	37 DOL
LAVELLO TURCHIA 100 SINIS.	37 DOL
<b>LAVELLI IN ACCIAIO INOX</b>	
LAVELLO INOX SC/DS 80X50	179 MER
LAVELLO INOX SC/DS 90X50	179 MER
LAVELLO INOX SC/DS 100X50	179 MER
LAVELLO INOX SC/DS 120X50	179 MER
LAVELLO INOX SC/SN 80X50	180 MER
LAVELLO INOX SC/SN 90X50	180 MER
LAVELLO INOX SC/SN 100X50	180 MER
LAVELLO INOX SC/SN 120X50	180 MER
<b>LUCI PER SPECCHI INDA</b>	
FARETTO CROMO	179 IND
GRUPPO LAMP.PAR. FA CROMO	179 IND
GRUPPO LAMP.PAR. FB CROMO	179 IND
<b>MANIGLIONI PER DISABILI</b>	
MANIGLIONE 25 CM HANDY CRM	175 IND
MANIGLIONE ANG. MONT. DES.	52 THE
MANIGLIONE ANG. MONT. SIN.	52 THE
MANIGLIONE ORIZZ. 120 CM	51 THE
MANIGLIONE ORIZZ. 30 CM	51 THE
MANIGLIONE ORIZZ. 45 CM	51 THE
MANIGLIONE ORIZZ. 60 CM	51 THE
MANIGLIONE ORIZZ. 90 CM	51 THE
<b>MANOMETRO A U</b>	
MANOMETRO A U 600 MM	217 FRR
<b>MANOMETRO A U ACCESSORI</b>	
TUBO X MANOMETRO A U	217 FRR
<b>MANOMETRO DIFFERENZIALE</b>	
MANOMETRO STICK 505 P1	216 TES
<b>MASTICE EPOSSIDICO PER RIPARAZIONE PERDITE</b>	
EPOSTIX 50 G	247 FAC
<b>MENSOLE IN PLASTICA</b>	
MENSOLA EVY BIAN	172 MPL
MENSOLA CM 56 LINEA BIANCO	170 MPL
MENSOLA CM 60 LINEA BIANCO	170 MPL
<b>MENSOLINE PER VECCHI LAVABI</b>	
COPPIA MENSOLINE INOX	137 MAV
<b>MISCELATORI BONOMI SERIE BARI</b>	
MIX BIDET BARI CRO	98 MPB
MIX DOCCIA EST. BARI CRO	98 MPB
MIX DOCCIA INC. BARI CRO	98 MPB
MIX LAVABO BARI CRO	98 MPB
MIX LAVEL.MURO BARI CRO	98 MPB
MIX VASCA C/DOC. BARI CRO	98 MPB
<b>MISCELATORI BONOMI SERIE COMO</b>	
MIX BIDET COMO 1 CRO	95 MPB
MIX DOCCIA COMO 1 CRO	96 MPB
MIX LAVABO COMO 1 CRO	95 MPB
MIX LAVEL M.FORO COMO CR	96 MPB
MIX LAVELLO MURO COMO CR	96 MPB
MIX VASCA COMO 1 C/DOC C	96 MPB
<b>MISCELATORI BONOMI SERIE VERONA</b>	
MIX BIDET VERONA CRO	96 MPB
MIX DOC INC C/DEV VERON CR	97 MPB
MIX DOCCIA INC VERONA CRO	97 MPB
MIX EST DOCCIA VERONA CRO	97 MPB
MIX LAV MON B/SPOS VERO CR	97 MPB
MIX LAVABO VERONA CRO	96 MPB
MIX LAVEL A MURO VERONA CR	98 MPB
MIX LAVEL MON VERONA CROM	97 MPB
MIX LAVEL1FC/ALT VERONA CR	97 MPB
MIX MON.PARRUCCH. VERONA	97 MPB
MIX VASCA C/D VERONA CRO	96 MPB
<b>MISCELATORI CUSIO PER SOSTITUZIONI VECCHIE SERIE</b>	
MIX CUSIO EST.X DOCCIA CR	104 DTA
MIX CUSIO X BIDET MON CR	104 DTA

DESCRIZIONE	PAGINA	FORNITORE	'DESCRIZIONE	PAGINA	FORNITORE
MIX CUSIO X LAVABO MON CR	104	DTA	MISC. DOCCIA MK3	100	RAP
MIX CUSIO X VASCA C/SET CR	104	DTA	MISC. LAV. DOCC/ESTR. MK3	101	RAP
VITONE X CUSIO INC.DOC 5/8	104	DTA	MISC. LAVABO MK3	100	RAP
<b>MISCELATORI GROHE SERIE CHIARA</b>			MISC. MONOF. LAVELLO MK3	101	RAP
CHIARA MIX BIDET CROMO	72	GRO	MISC. VASCA ESTERNO MK3	100	RAP
CHIARA MIX BIDET CROMO/ORO	73	GRO	MISCELATORE PARETE MK3	101	RAP
CHIARA MIX LAVABO CROMO	71	GRO	<b>MISCELATORI SOL SERIE BRAVA</b>		
CHIARA MIX LAVABO CR.ORO	72	GRO	MIX BIDET BRAVA C/S CR	86	SOL
CHIARA MIX LAVABO BOC ESTR	73	GRO	MIX INCAS DOCCIA BRAVA CR	87	SOL
CHIARA MIX VASCA CROMO	72	GRO	MIX LAVABO BRAVA C/S CR	86	SOL
CHIARA MIX VASCA CROMO/ORO	73	GRO	MIX LAVELLO BRAVA B/GIR.CR	87	SOL
<b>MISCELATORI GROHE SERIE EURODISC</b>			MIX LAVELLO PARETE BRAVA	87	SOL
EURODISC MIX BIDET CR	66	GRO	MIX VASCA C/DUPL BRAVA CR	86	SOL
EURODISC MIX EST DOC C/DEV	66	GRO	<b>MISCELATORI SOL SERIE PRIMA</b>		
EURODISC MIX EST DOCCIA	66	GRO	MIX BIDET C/S PRIMA CR	83	SOL
EURODISC MIX LAVABO CR	66	GRO	MIX BIDET C/S PRIMA BIA	85	SOL
EURODISC MIX LAVEL A/LAVAT	67	GRO	MIX INC DOC C/BIL PRIMA CR	84	SOL
EURODISC MIX LAVEL MURO CR	67	GRO	MIX INCASSO DOCC PRIMA CR	84	SOL
EURODISC MIX LAVELLO MONOF	67	GRO	MIX INCASSO DOCC PRIMA BIA	85	SOL
EURODISC MIX VASCA CR	66	GRO	MIX LAV MF ULAT PRIMA T/F	86	SOL
EURODISC SOLO ROSONE S/DEV	66	GRO	MIX LAV MON D/ES PRIMA BIA	85	SOL
<b>MISCELATORI GROHE SERIE EUROPLUS 2</b>			MIX LAVABO C/S PRIMA CR	83	SOL
EUROPLUS 2 MIX BIDET D/EST	70	GRO	MIX LAVABO C/S PRIMA BIA	85	SOL
EUROPLUS 2 MIX LAVAB D/EST	70	GRO	MIX LAVEL MONOF PRIMA CR	84	SOL
EUROPLUS DUE DOCCIA EST.CR	70	GRO	MIX LAVEL MONOF PRIMA BIA	85	SOL
EUROPLUS DUE LAVEL.C/DOC C	71	GRO	MIX LAVEL.PARETE PRIMA GRO	84	SOL
EUROPLUS DUE LAVELLO CR	71	GRO	MIX LAVELLO PAR PRIMA BIA	86	SOL
EUROPLUS DUE MIX BIDET CR	70	GRO	MIX VASCA C/DUPL PRIMA CR	84	SOL
EUROPLUS DUE MIX LAVABO CR	70	GRO	MIX VASCA CIDUPL PRIMA BIA	85	SOL
EUROPLUS DUE MIX VASCA CR	70	GRO	<b>MISCELATORI SOL SERIE PUNTA</b>		
EUROPLUS DUE ROSONE C/D.CR	71	GRO	MIX BIDET PUNTA CR	82	SOL
EUROPLUS DUE ROSONE S/D.CR	71	GRO	MIX DOCCIA INC PUNTA CR	82	SOL
<b>MISCELATORI GROHE SERIE EUROSART</b>			MIX EST DOCCIA PUNTA CR	82	SOL
EUROSART INC DOC C/DEV CR	64	GRO	MIX LAVABO PUNTA CR	81	SOL
EUROSART INC DOC S/DEV CR	64	GRO	MIX LAVABO PUNTA LEVALUNGA	82	SOL
EUROSART LAVELLO MONOF CR	64	GRO	MIX LAVEL DOC/EST PUNTA CR	83	SOL
EUROSART MIX BIDET CR	64	GRO	MIX LAVEL MON B/L PUNTA CR	83	SOL
EUROSART MIX EST DOCC CR	64	GRO	MIX LAVELLO MONOF PUNTA CR	83	SOL
EUROSART MIX LAVABO CR	64	GRO	MIX LAVELLO PAR PUNTA CR	83	SOL
EUROSART MIX VASCA C/D CR	64	GRO	MIX VASCA C/D PUNTA CR	82	SOL
<b>MISCELATORI GROHE SERIE EUROSTYLE</b>			PIASTRA X INC DOCCIA PUNTA	83	SOL
EUROSTYLE INC DOC C/DEV CR	65	GRO	<b>MISCELATORI SOL SERIE SMART</b>		
EUROSTYLE INC DOC S/DEV CR	65	GRO	MIX BIDET 1.1/4 SMART CR	87	SOL
EUROSTYLE LAVELLO B/ALT CR	65	GRO	MIX EST DOCCIA SMART CR	88	SOL
EUROSTYLE LAVELLO MONOF CR	65	GRO	MIX INC DOCCIA SMART CR	88	SOL
EUROSTYLE LAVELLO MURO CR	65	GRO	MIX LAVABO 1.1/4 SMART CR	87	SOL
EUROSTYLE MIX BIDET CR	65	GRO	MIX LAVEL MON B/GI SMART C	88	SOL
EUROSTYLE MIX EST DOCC CR	65	GRO	MIX LAVEL MON B/LA SMART C	88	SOL
EUROSTYLE MIX LAVABO CR	64	GRO	MIX LAVELLO PAR SMART CR	88	SOL
EUROSTYLE MIX VASCA C/D CR	65	GRO	MIX VASCA C/D SMART CR	88	SOL
<b>MISCELATORI GROHE SERIE EUROWING</b>			<b>MISCELATORI SOL SERIE TALENTO</b>		
EUROWING BIDET CROMO/ORO	69	GRO	MIX BIDET TALENTO CR	89	SOL
EUROWING LAVABO CROMO/ORO	69	GRO	MIX DOCCIA INC TALENTO CR	89	SOL
EUROWING MIX BIDET	68	GRO	MIX EST DOCCIA TALENTO CR	89	SOL
EUROWING MIX EST DOCCIA	68	GRO	MIX LAVABO TALENTO CR	89	SOL
EUROWING MIX LAVABO	68	GRO	MIX VASCA C/D TALENTO CR	89	SOL
EUROWING MIX LAVEL C/DOC/E	69	GRO	<b>MISCELATORI TERMOSTATICI</b>		
EUROWING MIX LAVELLO	69	GRO	CORPO INCAS TERMOST CHIARA	72	GRO
EUROWING MIX VASCA	68	GRO	CORPO INCASSO MIX TERMOST	90	SOL
EUROWING ROSONE C/DEV	68	GRO	CORPO X MIX TERMOST 34310	75	GRO
EUROWING ROSONE S/DEV	69	GRO	ESTERNO X MIX TERMOS 34310	75	GRO
EUROWING VASCA CROMO/ORO	69	GRO	MIX DOCCIA EST TERM ECH CR	90	SOL
<b>MISCELATORI IDEAL STANDARD</b>			MIX EST TERM ZEPPELIN CR	90	SOL
MIX LAVELLO DOC/ESTR	79	DE	MIX TERMOST C/DOC LEVA 1/2	108	RVR
MIX LAVELLO DOC/ESTR X LAV	79	DE	MIX TERMOST DN 15 CASTOR	108	RVR
<b>MISCELATORI IDEAL STANDARD SERIE CERAMIX</b>			MIX TERMOST DN 20 CASTOR	108	RVR
CERAMIX GR BIDET	78	DE	MIX TERMOST EST X DOCCIA	75	GRO
CERAMIX GR DOCCIA	79	DE	MIX TERMOST MINICASTOR 3/4	108	RVR
CERAMIX GR EST VASC/D	79	DE	PARTE EST X DOC TERM CHIAR	72	GRO
CERAMIX GR INC VASC/D	79	DE	SET PARTI EST X TERMOS INC	90	SOL
CERAMIX GR LAVEL PAR	79	DE	<b>MOBILETTI PER BAGNO</b>		
CERAMIX GR LAVELLO	79	DE	MOBILE FARMACIA FREJUS BIA	173	C-M
CERAMIX GR MON LAVABO	78	DE	MOBILE S.MORITZ 55X38 BIAN	174	C-M
<b>MISCELATORI IDEAL STANDARD SERIE CERAMIX 2000</b>			MOBILE S.VINCENT 65X48 BIA	173	C-M
CERAMIX 2000 GR BIDET CR	78	IDE	SPECCHIERA GHANA C/LU BIAN	174	C-M
CERAMIX 2000 GR DOCCIA INC	78	IDE	<b>MOBILI PER LAVANDERIA</b>		
CERAMIX 2000 GR EST VASC/D	78	IDE	M.LAVATOIO 45X50 TORRENT.B	183	PST
CERAMIX 2000 GR LAVABO CR	78	IDE	M.LAVATOIO 45X60 TORRENT.B	183	PST
<b>MISCELATORI IDEAL STANDARD SERIE CERAPLAN</b>			M.LAVATOIO 60X50 TORREN.BI	183	PST
CERAPLAN GR BIDET CROM	80	IDE	M.LAVATOIO 60X60 TORREN.BI	183	PST
CERAPLAN GR LAVABO CROM	80	IDE	MOBILAV.MESSICO NUOVO 60	183	PST
CERAPLAN GR INC DOCC CROM	80	IDE	MOBILE C/LAVAT 45X60 BIA	183	PST
CERAPLAN GR VASCA/DOC CROM	80	IDE	MOBILE C/LAVAT 60X60 BIA	183	PST
<b>MISCELATORI RAPETTI SERIE MK3</b>			MOBILE LAVAT MESSICO 75X60	183	PST
MISC. BIDET MK3	100	RAP	MOBILE LAVATOIO ISIDE	183	PST



DESCRIZIONE	PAGINA	FORNITORE
<b>MOBILI PER LAVANDERIA MONTEGRAPPA</b>		
MOBIL.LAVAT.45X50 DX S/CES	182	MTG
MOBILE C/LAVABO 70X50 BIAN	183	MTG
MOBILE LAVAT. 80 CM C/CEST	182	MTG
MOBILE X LAVAT.109 BIAN	182	MTG
PILOZZO LAVATOIO PERU 45CM	182	MTG
PILOZZO LAVATOIO PERU 60CM	182	MTG
<b>MOLLA NETTATUBI</b>		
NETTATUBI A MOLLA CM 500	239	MAV
NETTATUBI N.1 1.5 M	239	LEO
<b>MOLLA NETTATUBI ELETTRICA .</b>		
STASATRICE C/TRAP K 39-5	228	RID
<b>MORSE DA BANCO</b>		
MORSA BANCO PROFES 100X11	234	VEP
MORSA BANCO PROFES 125X11	234	VEP
<b>MORSE IDRAULICO</b>		
MORSA PER TUBO FISSA 4	234	FZA
MORSA PER TUBO RIBALTAB. 2	234	FZA
<b>MORSETTI PER TURCA</b>		
MORSETTO TURCA	118	GFB
<b>MORSETTI PER WC</b>		
MORSETTO WC BIANCO 50 X 32	139	CLB
MORSETTO WC BIANCO 55 X 32	139	CLB
MORSETTO WC BIANCO 55 X 40	139	CLB
MORSETTO WC BIANCO 60 X 32	139	CLB
MORSETTO WC BIANCO 60 X 40	139	CLB
<b>NASTRO ALLUMINIO</b>		
NASTRO ADES.ALLUMINIO 5X50	247	FAC
NASTRO ADES.ALLUMINIO 10X50	247	FAC
<b>NASTRO SEGNALE PER SCAVI</b>		
BENDA ATTENZIONE ACQUA	247	FAC
BENDA ATTENZIONE GAS GIAL.	247	FAC
<b>OLIO PER FILIERE</b>		
OLIO X FILETT LATTINA L 5	227	RID
OLIO X FILETT LATTINA L25	227	RID
OLIO X FILETTARE SPRAY	227	RID
<b>ORINATOI ACCESSORI</b>		
BICCHIERE X ORINATOIO 055	106	TRE
CURVA ORINATOIO C/BICC	106	RAF
PILETTA CUFFIA X ORIN 065	106	RAF
PILETTA CUFFIA X ORIN 082	106	RAF
RUBINETTO C/CAPP ORIN 3/8	106	TRE
<b>ORINATOI CERAMICA DOLOMITE</b>		
ORINATOIO BADIA BIAN	36	DOL
<b>ORINATOI CERAMICA GALASSIA</b>		
ORINATOIO SIRIO BIAN	24	GAL
<b>ORING DI RICAMBIO</b>		
ANELLO OR 12.1X2.7 5PZ	139	TIR
ANELLO OR 13.6X2.7 5PZ	139	TIR
ANELLO OR 15.1X2.7 5PZ	139	TIR
ANELLO OR 18.77X1.78 5PZ	139	TIR
ANELLO OR 27.8X3.6 5PZ	139	TIR
ANELLO OR 34.1X3.6 5PZ	139	TIR
ANELLO OR 36.1X3.53 5PZ	139	TIR
ANELLO OR 37.3X3.6 5PZ	139	TIR
ANELLO OR 5.7X1.9 5PZ	139	TIR
ANELLO OR 6.4X1.9 5PZ	139	TIR
ANELLO OR 7.2X1.9 5PZ	139	TIR
ANELLO OR 44.45X3.53 5PZ	139	TIR
ANELLO OR 58.74X3.53 5PZ	139	TIR
<b>OLYMPIA SANITARI SERIE AMBRA</b>		
BIDET MONO/TREF AMBRA BIA	27	OLY
COLONNA AMBRA BIA	26	OLY
LAVABO AMBRA CM 60 BIA	26	OLY
VASO UNI S/PAV AMBRA BIA	26	OLY
<b>PARACOLPI PER SEDILI</b>		
GOMMINI X SEDILE	47	FRG
KIT PARACOLPI ATLANT BIAN	48	C-M
KIT PARACOLPI ATLANT NERO	48	C-M
KIT PARACOLPI S 12 BIAN	48	C-M
KIT PARACOLPI S 12 NERO	48	C-M
PARACOLP TONDO H 10 MM	47	FRG
PARACOLP TONDO H 7.5 MM	47	FRG
PARACOLP 2 CHIODI H 10 MM	47	FRG
PARACOLP 2 CHIODI H 12 MM	47	FRG
PARACOLP 2 INNISTI 10 MM	47	FRG
PARACOLP SED. ALPIN/QUADR	44	DOL
PARACOLP SED. CLODIA-FLEO	44	DOL
PARACOLP SEDILE CONCA SP.	47	FRG
PARACOLP SEDILE RIO	44	DOL
PARACOLP X SED.AERO/CALLA	47	IDE
PARACOLP X SEDILI IDEAL	47	IDE
<b>PARAFOGLIE PER PLUVIALI</b>		
PARAFOGL A ZINCATA 060-120	200	ETE

DESCRIZIONE	PAGINA	FORNITORE
<b>PASTA VERDE PER FILETTI</b>		
MASTICE X GAS KOLGAS	245	FAC
SILICON 0.500 KG	245	FAC
<b>PEDANE PER DOCCIA</b>		
PEDANA DOCCIA 53X53 BIAN	171	MPL
<b>PETTINI PER FILIERE</b>		
BUSSOLA BSPT X R200 1/2	224	RID
BUSSOLA BSPT X R200 3/8	224	RID
PETTINI X FIL. 11R 1/2	227	RID
PETTINI X FIL. 11R 1	227	RID
PETTINI X FIL. 11R 1.1/4	227	RID
PETTINI X FIL. 11R 3/4	227	RID
PETTINI X FIL. 11R 3/8	227	RID
PETTINI X FIL. 815 1/2-3/4	226	RID
PETTINI X FIL. 815 1/4-3/8	226	RID
PETTINI X FIL. 815 1-2	226	RID
PETTINI X FIL. R200 1	224	RID
PETTINI X FIL. R200 1.1/2	224	RID
PETTINI X FIL. R200 1.1/4	224	RID
PETTINI X FIL. R200 1/2	224	RID
PETTINI X FIL. R200 2	224	RID
PETTINI X FIL. R200 3/4	224	RID
PETTINI X FIL. R200 3/8	224	RID
PETTINI X FILIERA 141	226	RID
<b>PIANTANE INDA</b>		
PIANT.P.SALV.COLORELLA CR	177	IND
PIANTANA BASSA COLOR.CROM	177	IND
PIANTANA BASSA COLOREL.BIA	177	IND
PIANTANA P.SALVIETTE BIA	177	IND
<b>PIANTANE METAFORM</b>		
PIANTANA DANDY 2 ALTA BIAN	171	MPL
<b>PIATTI DOCCIA ACCIAIO</b>		
PIATTO DOCCIA ACC 70 BIAN	60	MER
PIATTO DOCCIA ACC 80 BIAN	60	MER
<b>PIATTI DOCCIA CERAMICA DOLOMITE</b>		
PIATTO BRIDGE 120X80 BIAN	40	DOL
PIATTO GOLF 66 BIAN	39	DOL
PIATTO GOLF 76 BIAN	39	DOL
PIATTO GRECIA 80 ANG. BIAN	39	DOL
PIATTO LIBIA 80 BIAN	39	DOL
PIATTO LIBIA 90 BIAN	39	DOL
PIATTO POLO 73X91 BIAN	39	DOL
PIATTO SURF ANGOLO 90 BIAN	39	DOL
<b>PIATTI DOCCIA CERAMICA GALASSIA</b>		
PIATTO AIRONE 90X90 BIAN	22	GAL
PIATTO ALBATRO 75X75 BIAN	22	GAL
PIATTO ALBATROS 80X80 BIAN	22	GAL
PIATTO NIBBIO 70X85 BIAN	22	GAL
PIATTO PEGASO 70X70 BIAN	22	GAL
PIATTO PLAZA 80X120 BIAN	23	GAL
PIATTO TEBE 72X90 BIAN	22	GAL
PIATTO VENUS 80 ANG BIAN	23	GAL
PIATTO VENUS 90 ANG BIAN	23	GAL
<b>PIATTI DOCCIA CERAMICA IDEAL STANDARD</b>		
PIATTO DOCCIA 75 BIAN	17	DE
PIATTO DOCCIA 75X90 BIAN	18	DE
PIATTO DOCCIA 80 BIAN	17	DE
PIATTO DOCCIA 100X75 BIAN	18	DE
PIATTO DOCCIA 120X80 BIAN	18	DE
PIATTO DOCCIA 70 ALTO BIAN	19	DE
PIATTO DOCCIA 70X85 BIAN	18	DE
PIATTO DOCCIA 90X90	18	DE
PIATTO DOCCIA ANG 80 BIAN	19	DE
PIATTO DOCCIA ANG 90 BIAN	19	DE
PIATTO DOCCIA DIDONE 75 B.	17	DE
PIATTO DOCCIA DIDONE 80 B.	17	DE
<b>PILETTE ACCESSORI</b>		
SNODINO HOSTAFORM X BIDET	116	VSN
SNODINO LUX OTTONE/NICHEL	116	VSN
<b>PILETTE IN PLASTICA ACCESSORI</b>		
RIDUZIONE 1.1/2FX1.1/4M	126	OLV
RIDUZIONE 1.1/2MX1.1/4F	126	EMU
<b>PILETTE IN PLASTICA PER DOCCIA</b>		
PILETTA SIFOIDE DOCCIA	122	EMU
SIFONE A S X DOCCIA DN 80	122	EMU
SIFONE DOCCIA SNODO C/COP.	122	EMU
SIFONE DOCCIA UNIVERSALE	122	EMU
SIFONE X DOCCIA ACC. 1.1/2	120	GEB
SIFONE X DOCCIA GRES 2	120	GEB
<b>PILETTE IN PLASTICA PER DOCCIA RICAMBI</b>		
GRIGLIA X PILETTA DOCCIA	120	GEB
<b>PILETTE IN PLASTICA PER LAVELLO</b>		
PILETTA C.T.P. X LAVEUINX	126	EMU
PILETTA S.T.P. X LAVEL/INX	126	EMU
PILETTA X SIFONE LAVELLO	125	EMU





DESCRIZIONE	PAGINA FORNITORE
-------------	------------------

PORTAG.DOPPIO SCAR.LAV 015	119 IPR
PORTAG.DOPPIO SCAR.LAV 017	119 IPR
PORTAG.DOPPIO SCAR.LAV 022	119 IPR
PORTAG.LAVAT.SQ. DADO PLAS	119 GFB
PRESA SCAR X TUBI 25-32 MM	119 IPR
RACCORDO DOPPIO CAR LAVATR	119 IPR
<b>RACCORDI PER FRIGORISTI</b>	
AEROEQUIP RAME C/ATT 1/2	215 REC
AEROEQUIP RAME C/ATT 1/4	215 REC
AEROEQUIP 3/8 A SALD CNAL	215 REC
BOCCHETTONE NS4 3/8FORO 8	215 REC
BOCCHETTONE NS4-1/2FORO 10	215 REC
BOCCHETTONE NS4-10 5/8	215 REC
BOCCHETTONE NS4-12 TUB 3/4	215 REC
BOCCHETTONE NS4-4 1/4	215 REC
BOCCHETTONE NS4-5 5/16 SAE	215 REC
BOCCHETTONE NS4-6 TUBO 3/8	215 REC
BOCCHETTONE NS4-8 1/2	215 REC
CAPPELLOTTO X VALVOLINA	215 REC
GIRELLO CIECO C/GUARNIZION	219 REC
GIUNTO DIR U2-10 SAE 5/8	215 REC
GIUNTO DIR U2-12 SAE 3/4	215 REC
GIUNTO DIR U2-4 SAE 1/4	215 REC
GIUNTO DIR U2-5 SAE 5/16	215 REC
GIUNTO DIR U2-6 SAE 3/8	215 REC
GIUNTO DIR U2-8 SAE 1/2	215 REC
GIUNTO DR 1/4 PER POMPA	214 REC
GIUNTO DR RID UR2 1/2X5/8	215 REC
GIUNTO DR RID UR2 1/4X3/8	215 REC
GIUNTO DR RID UR2 3/4X1/2	215 REC
GIUNTO DR RID UR2 3/8X1/2	215 REC
RACCORD GIREV 1/4SAEFX5/16	219 REC
RACCORD GIREV 5/16FX1/4 SA	219 REC
RACCORDO DR-GIREV.1/4RG180	219 REC
RACCORDO GIREVOLE ANG. 1/4	219 REC
RIDUZ.BOMEGAS.FREON 1/4S	218 REC
RIDUZIONE BOMBOLA 5/16	218 REC
RIDUZIONE UR3-86 MF1/2-3/8	215 REC
RIDUZIONE UR-46 MF 1/4-3/8	215 REC
TRONCHETTO CU ST80 5/8 AER	215 REC
VALV.SERV. 1/4 MM CVAL+CAP	214 REC
VALV.SERV.SALD.MM6+VAL+CAP	214 REC
VALVOLA GIREVOLE 121 RG-4	215 REC
VALVOLINA SCHRAEDER 870632	214 REC
<b>RASCHIATUBI PER POLIETILENE</b>	
RASCHIATUBI RTC 160	223 IDH
RASCHIATUBO 0 50-160 X PE	223 IDH
<b>REGGITENDA</b>	
REGGIT.AQUABOX DOCC.L CROM	175 IND
REGGIT.AQUABOX DOCC.O CROM	174 IND
REGGIT.AQUABOX VASC U CROM	175 IND
<b>RESISTENZE PER SCALDABAGNI</b>	
RESIST X SCALD BLUK 50-80L	185 MER
RESIST X SCALD PERL 30L	185 MER
RESIST X SCALD PERL 10-15L	185 MER
RESIST. SCALD. LEGNA-ELETT	196 SIT
RESISTENZA 1.1/4 1200 W	186 CLB
RESISTENZA 1200 FLANG NUOV	196 SIT
RESISTENZA FLANG.1200 DIR	186 CLB
<b>RICAMBI PER CASSETTA DORA</b>	
ESTRATTORE UNIVERS X DORA	150 FA
GUARNIZIONE A SCODELLINO	152 FA
GUARNIZIONE PARA FONDELLO	150 FA
IMBUTO PLASTICA CROMATO	150 FA
INSERTO X DORA GROSSO	150 FA
INSERTO X DORA PICCOLO	150 FA
PALLINA PARA X CASS. DORA	150 LEO
PLACCA INT X DORA P80 BIAN	150 FA
PLACCA INT. DORA C/PULSANT	150 CLB
PLACCA PL.X DORA P80 BIANC	150 FA
PLACCA PLAST X DORA BIANCA	150 FA
PLACCA PLASTICA CHAMPAGNE	150 FA
PROLUNGA P80	150 FA
PULS. PLAST.DORA CROMATO	150 FA
VITE X PLACCA	150 FA
<b>RICAMBI PER CASSETTA PUCCI</b>	
CONF.PUC.GAMBET-DADI-PAST	151 CLB
CONF.SFERA TENUTA PUCCI	152 CLB
ESTRATTORE PER CASS. PUCCI	151 CLB
GUARNIZIONE FONDO X PUCCI	152 LEO
PISTONCINO X CASS PUCCI	151 CLB
PLACCA BIANCA PER PUCCI	151 CLB
PULSANTE COMPLETO PUCCI	151 CLB
ROSONE E BOCC. CROM.PUCCI	151 CLB
SET GUARNIZIONI PUCCI	152 LEO

DESCRIZIONE	PAGINA FORNITORE
-------------	------------------

SPORTELLO INT.SCAR.CO PUCC	152 CLB
<b>RICAMBI PER CASSETTA RAMO</b>	
SFERA X CASSETTA RAMO	155 LEO
<b>RICAMBI PER CASSETTA STIR BLITZ</b>	
PLACCA EST BIA STIL-BLITZ	155 CLB
PLACCA KIT EST STIL-BLITZ	155 CLB
PULSANTE STIR-BLITZ	155 CLB
<b>RICAMBI PER CASSETTA TAGO</b>	
GRUPPO PULSANTE RETT	150 FAI
GRUPPO PULSANTE TONDO	150 FAI
<b>RICAMBI PER CASSETTE</b>	
SFERA TENUTA C/NOTTOLINO	155 MAV
<b>RIDGID RICAMBI</b>	
ADATTAT 1/2 BSP - M16 ADPT	229 RID
ADATTAT DA MANDR A 1/2 BSP	229 RID
ALESATORE COMPLETO	238 RID
ALESATORE MOD.127	239 RID
ANELLO	238 RID
ANELLO	238 RID
CARBONCINI	237 RID
CARBONCINI X 114-600-690	237 RID
CONO ALESAT	238 RID
COP CARBONC X LECTRA COMBI	243 RID
COP ELETTR X LECTRA CILIN	243 RID
COPERCHI	237 RID
DADO	238 RID
GRILLETTO	238 RID
INDOTTO	237 RID
INTERRUTTORE	237 RID
INVERTITORE X 114-600-690	237 RID
LEVA	238 RID
LEVA	238 RID
LEVA X 855-815	238 RID
MOLLA	238 RID
OLIATORE	238 RID
PERNO X TESTATA	238 RID
RONDELLA	237 RID
SERIE INSERTI	237 RID
SPINOTTO	238 RID
TUBO LUBRIFIC	238 RID
TUBO OLIO	238 RID
VITE	238 RID
VITE	238 RID
VITE E515 - 312	238 RID
VITI	238 RID
<b>RILEVATORE PORTATILE FUGHE GAS</b>	
RILEV.PORT.FUGH.GAS SET100	217 FRR
<b>ROSETTE CROMATE</b>	
ROSETTA APRIBILE CR 1	114 EDR
ROSETTA APRIBILE CR 1.1/4	114 EDR
ROSETTA APRIBILE CR 1/2	114 EDR
ROSETTA APRI BILE CR 3/4	114 EDR
ROSETTA APRIBILE CR 3/8	114 EDR
ROSETTA CROMATA 1/2	113 EDR
ROSETTA H 10 MM DA 1/2	114 TIR
<b>ROSETTE INOX</b>	
ROSETTA INOX 1	113 MAV
ROSETTA INOX 1/2	113 MAV
ROSETTA INOX 3/4	113 MAV
ROSETTA INOX 3/8	113 MAV
<b>ROSONI BIANCHI PER CAMINI</b>	
ROSONE STUFA BIANCO N 10	200 MRV
ROSONE STUFA BIANCO N 11	200 MRV
ROSONE STUFA BIANCO N 12	200 MRV
ROSONE STUFA BIANCO N 13	200 MRV
ROSONE STUFA BIANCO N 14	200 MRV
ROSONE STUFA BIANCO N 15	200 MRV
ROSONE STUFA BIANCO N 16	200 MRV
ROSONE STUFA BIANCO N 18	200 MRV
ROSONE STUFA BIANCO N 20	200 MRV
ROSONE STUFA BIANCO N 8	200 MRV
ROSONE STUFA BIANCO N 9	200 MRV
<b>ROSONI CROMATI</b>	
409S ROSONE OV. CAS ALT 30	114 EDR
412 ROSONE CROMATO 1/2 D72	114 EDR
412 ROSONE CROMATO 3/4	114 EDR
412 ROSONE CROMATO 3/8	114 EDR
412/H ROSONE SCAT.01/2 H20	114 EDR
415 ROSONE ALTO X CAN. 026	114 EDR
415 ROSONE ALTO X CAN. 030	114 EDR
415 ROSONE ALTO X CAN. 032	114 EDR
415 ROSONE ALTOXCAN OT 032	114 EDR
415/G ROSONE GIG. D100 F32	114 EDR
ROSONE A MURO 0 40X77 CROM	114 TIR

**DESCRIZIONE PAGINA FORNITORE**

<b>ROTELLE PER TAGLIATUBI</b>		
ROTELLA TAGLIATUBI 1/8-2	220	PAS
ROTELLA PER INOX X150-205	222	RID
ROTELLA PN 16 D.127 290316	223	COU
ROTELLA RI.TAG.84145-84149	222	COU
ROTELLA RIC. 28/42 X 84144	222	COU
ROTELLA RIC. TAGL.PL 737	223	COU
ROTELLA RIC. X TAGL. 84146	223	COU
ROTELLA RIC.INOX X TAGL 67	222	COU
ROTELLA RIC.X S/EGO 2	223	COU
ROTELLA RIC.X S/EGO 4	223	COU
ROTELLA RIC.X S/EGO 1.1/4	223	COU
ROTELLA RIC.X S/EGO 751-52	223	COU
ROTELLA TAGLIAT. 1-2 F-514	221	RID
ROTELLA TAGLIAT. 4 F-515	221	RID
ROTELLA TAGLIATUBI 2-4	220	PAS
ROTELLA TAGLIATUBI RAME/PL	222	RID
ROTELLA TAGLIATUBO MOD 28	222	DAM
ROTELLE PER TAGLIAT.140	223	IDH
<b>RUBINETTERIA BONOMI</b>		
ATTACCHIN PROLUNGATO X MIX	99	MPB
FLESS X MIX LEVEL MEG 150	98	MPB
<b>RUBINETTERIA BONOMI RICAMBI</b>		
CANNA FUSA PESANTE LAVELLO	99	MPB
COPPIA GUARNIZIONE X 75000	100	MPB
DEVIATORE X BONOMNERS CRO	99	MPB
LEVA CLINICA VERONA DRITTA	99	MPB
LEVA CLINICA VERONA INCLIN	99	MPB
LEVA VERONA	99	MPB
VALVOLA DEVIATR X GR VASCA	99	MPB
<b>RUBINETTERIA GROHE</b>		
CORPO INCASSO C.DEV UNIVER	67	GRO
CORPO INCASSO S.DEV UNIVER	67	GRO
MIX LEVEL. LADILUX BIANCO	75	GRO
<b>RUBINETTERIA GROHE SERIE ADRIA</b>		
ADRIA BATT. BIDET MONOF	74	GRO
ADRIA BATT. LAVABO MONOF	73	GRO
ADRIA BATT. LAVELLO MONOF	74	GRO
ADRIA BATTERIA BIDET 3F	73	GRO
ADRIA BATTERIA LAVABO 3F	73	GRO
ADRIA BATTERIA LAVEL PAR	74	GRO
ADRIA GRUPPO VASCA EST C/D	74	GRO
ADRIA RUBINETTO INC. 1/2	74	GRO
ADRIA RUBINETTO INC. 1/2	74	GRO
<b>RUBINETTERIA GROHE RICAMBI</b>		
ADATTATORE 1/2X3/4 CROMATO	160	GRO
CALOTTA X 28620	77	GRO
CHIAVE X MOUSSEUR	77	GRO
FLESSIBILE X LADYLUX	75	GRO
GHIERA DISTANZ	77	GRO
LEVA CON GANASCE	76	GRO
LEVA EUROPLUS	76	GRO
LIQUIDO DETERG. GROHCLEAN	77	GRO
PIASTRINA COP EUROD	77	GRO
PIASTRINA X LADYLUX	75	GRO
PLACCHETTA EU-PLUS CROMATA	76	GRO
RACCORDO AUT X LADY	75	GRO
SET GUARNIZIONI X 33891	75	GRO
TESTATA SENZA LEVA	76	GRO
TUBETTO GRASSO X OR	76	GRO
O-RING 0 47.22 X 3.53	104	HAN
<b>RUBINETTERIA IDEAL STANDARD</b>		
TALENT GR BID CROM	81	IDE
TALENT GR LAV CROM	81	IDE
TALENT GR VAS CROM	81	IDE
<b>RUBINETTERIA IDEAL STANDARD RICAMBI</b>		
DADO E GUARNIZ FISS A 1521	81	IDE
DEVIATORE AUTOMAT/MANUALE	81	IDE
MANIGLIA CPL N.1 CR	81	IDE
O RING + TEFLON	81	IDE
O RING + TEFLON	81	IDE
O RING + TEFLON A1520/21	81	IDE
PROLUNGA PIASTRA	81	IDE
<b>RUBINETTERIA RAPETTI</b>		
BATTERIA LAV. C/SALT. 1 T	101	RAP
BATTERIA LAV. S/SALT. T	101	RAP
CARTUCCIA X MK2	101	RAP
GRUPPO LAVELLO A MURO T	102	RAP
GRUPPO LAVELLO MONOFORO T	102	RAP
GRUPPO VASCA C/DEV S/AC. T	101	RAP
RUBIN.PORT/GOMMA 1/2 MURO	102	RAP
RUBINETTO BIDET 1/2 T	101	RAP
RUBINETTO INC. DIR. 1/2 T	102	RAP
RUBINETTO LAVABO 1/2 T	101	RAP

**DESCRIZIONE PAGINA FORNITORE**

<b>RUBINETTERIA RAPETTI ACCESSORI</b>		
PROLUNGA X CARTUCCIA X MK	101	RAP
SCARICO BIDET 1	103	RAP
SCARICO BIDET 1.1/4	103	RAP
<b>RUBINETTERIA RAPETTI RICAMBI</b>		
AERATORE M X BOCCHE LAVABO	102	RAP
AERATORE X BOCCA IN TUBO	103	RAP
ANELLO ANTIFRIZ E GUARNIZ	103	RAP
CONF. GUARN. RUBIN. LAV.	103	RAP
DOCCIA NYLON BIANCA TANGA	104	RAP
DOCCIA SN 1/2	102	RAP
DOCCIA TANGA CIFLEX CR 120	104	RAP
FLESSIBILE X PARRUCC 120CM	103	RAP
GRANO 10 MM X PROL. RUBIN.	102	RAP
GRANO 15 MM X PROL. RUBIN.	102	RAP
GUARNIZ. X SEDE RUB. INC.	103	RAP
GUARNIZIONE X VITONE	138	RAP
INDICE BLU-ROSSO X TONDA	103	RAP
INSERTO X VITONE	103	RAP
MANIGLIA GARDA	103	RAP
MANIGLIA S/33 X MONOC. MK3	101	RAP
ROMPIGETTO X BOCCA IN TUBO	103	RAP
ROMPIGETTO X BOCCA LAVABO	103	RAP
ROMPIGETTO X BOCCA VASCA	103	RAP
SEDE C/CALOTTA 3/4	102	RAP
SEDE X RUBIN. BIDET	102	RAP
SEDE X RUBIN. INCASSO	102	RAP
SEDE X RUBIN. LAVABO	102	RAP
VITE 58 MM X GRANI PROL.	102	RAP
VITE FISSAGGIO VOLANTINO	103	RAP
VITONE UNIFICATO	103	RAP
VOLANTINO S/ TONDA	104	RAP
<b>RUBINETTERIE A FOTOCCELLULA</b>		
MIX L.BO CLASS 20M EL 220V	107	DMP
MIX LAVABO FULL 20 EL.220V	107	DMP
RUBIN ELET.CLASS 20M BT ME	107	DMP
<b>RUBINETTERIE A PEDALE PER COMUNITÀ</b>		
MIX PEDALE PARETE	105	RVR
MIX PEDALE PAVIMENTO 1 PED	104	RVR
MIX PEDALE PAVIMENTO 2 PED	105	RVR
RUBINETTO PEDALE A PARETE	105	RVR
RUBINETTO PEDALE A PAVIM	104	RVR
<b>RUBINETTERIE SOL</b>		
MIX MON LEVEL DIESTR DOMUS	89	SOL
PROLUNGA X RUBINET INCASSO	94	SOL
<b>RUBINETTERIE SOL ACCESSORI</b>		
COP RACC. COLON X GR BNAS	91	SOL
LEVA LUNGA CIPLAC X DOMUS	89	SOL
LEVA PROLUNGATA X PUNTO	83	SOL
LEVA PUNTA CITAP-VITE CR	83	SOL
SCARIC AUT BIDET MAXIMA CR	95	SOL
<b>RUBINETTERIE SOL SERIE CROCE</b>		
GR BIDET CIS CROCE CR	91	SOL
GR BIDET MF C/SAL CROCE CR	92	SOL
GR LAVA. MONOFORO CROCE CR	91	SOL
GR LAVA.3F BIBAS CROCE CR	91	SOL
GR LAVA.3F FUSA CROCE CR	91	SOL
GR LAVA.PES.TE MF CROCE CR	91	SOL
GR LAVELLO MONOF CROCE CR	92	SOL
GR VASCA C/DUPLEX CROCE CR	92	SOL
GR. LAVEL PARETE CROCE CR	92	SOL
GR.LAVA.3F B/ALT.CROCE CR	91	SOL
RUBINETTO INC 1/2 CROCE CR	92	SOL
<b>RUBINETTERIE SOL SERIE MAXIMA</b>		
GR LAV/LAVAT PAR MAXIMA CR	95	SOL
GR MON LAV/LAVAT MAXIMA CR	95	SOL
RUB.INCL.LAVEL MAN.MAXIMA	95	SOL
RUB.LAVEL DUPLEX MAXIMA CR	95	SOL
RUB.SNODO LAVEL MAX CR 1/2	95	SOL
<b>RUBINETTERIE SOL SERIE RIVA</b>		
GR BIDET MONOF RIVA CR	93	SOL
GR BIDET C/S 1.1/4 RIVA CR	93	SOL
GR ESTERNO DOCCIA RIVA CR	93	SOL
GR LAVABO C/S1.1/4 RIVA CR	92	SOL
GR LAVABO MONOF RIVA CR	93	SOL
GR LAVABO S/SALT. RIVA CR	92	SOL
GR LAVELLO MONOF RIVA CR	93	SOL
GR LAVELLO MURO RIVA CR	94	SOL
GR VASCA C/D RIVA CR	93	SOL
RUBINETTO BIDET RIVA CR	93	SOL
RUBINETTO INC RIVA 1/2 CR	94	SOL
<b>RUBINETTERIE TEMPORIZZATE</b>		
MIX LAVABO TEMPORIZZATO	106	RVR
RUBIN TEMP C/PULSANTE 1/2	106	RVR
RUBIN X ORINATOIO TEMP.1/2	106	RVR



DESCRIZIONE	PAGINA FORNITORE
RUBINETTO TEMPOR. BOC. BAS.	105 RVR
RUBINETTO TEMPOR. LAVABO	106 RVR
<b>RUBINETTI A IDRANTE</b>	
RUBINETTO IDRANT.SFERA 1	132 ITA
RUBINETTO IDRANT.SFERA 1/2	132 ITA
RUBINETTO IDRANT.SFERA 3/4	132 ITA
<b>RUBINETTI A LEVA LUNGA</b>	
GR. LAVELLO LEVE LUNG. MURO	109 EDR
RUBIN.COLLO CIGNO UL MONO	108 EDR
RUBINETTO LEVA LUNGA MURO	108 EDR
<b>RUBINETTI A PULSANTE IN OTTONE</b>	
RUBINETTO PULSANTE OT 1/2	130 MAV
<b>RUBINETTI A SFERA CON PORTAGOMMA</b>	
RUBIN SF PORT/LUCCHET 1/2	131 ENO
RUBIN SF PORT/LUCCHET 3/4	131 ENO
RUBIN. SFER P/GOMMA 1	132 ITA
RUBIN. SFER P/GOMMA 1/2	132 ITA
RUBIN. SFER P/GOMMA 3/4	132 ITA
RUBIN. SFER P/GOMMA 3/8	132 ITA
RUBINETTO SF PORT EKO 1	131 ENO
RUBINETTO SF PORT EKO 1/2	131 ENO
RUBINETTO SF PORT EKO 3/4	131 ENO
RUBINETTO SF PORT EKO 3/8	131 ENO
<b>RUBINETTI BOCCA DI LEONE</b>	
RUBIN SF BOCCA LEONE 1/2	130 MAV
<b>RUBINETTI COLONNINA BAR</b>	
RUB COLONNINA BAR RIVA CR	94 SOL
<b>RUBINETTI CON LEVA INCLINATA CROMATI</b>	
RUBINET. COLLO OTT CR 1/2	130 MAV
<b>RUBINETTI CON PORTAGOMMA</b>	
RUB PORTAG C/MAN S/CRO 1/2	131 RMM
RUBINETTO C/PORTAG LUC 1	130 ITA
RUBINETTO C/PORTAG LUC 1/2	130 ITA
RUBINETTO C/PORTAG LUC 3/4	130 ITA
RUBINETTO C/PORTAG LUC 3/8	130 ITA
RUBINETTO C/PORTAG OTT 1/2	130 RIG
RUBINETTO C/PORTAG OTT 3/4	130 RIG
<b>RUBINETTI INCASSO</b>	
CAPPUCCIO UNIV.X RUBIN INC	113 CLB
CAPPUCCIO UNIVERSALE OTTON	113 CLB
PROLUNG X RUB INC CAPP 1/2	135 ITA
PROLUNGA X RUBIN INC C/CAP	135 ITA
RUBIN. INCASSO CAP 1/2	134 ITA
RUBIN. INCASSO CAP 3/4	134 ITA
SARACINESCA INC C/CAPP 1	135 CIM
VALVOLA SF INC C/CAP 1/2	134 ITA
VALVOLA SF INC C/CAP 3/4	134 ITA
VALVOLA SF INC C/MAN 1/2	135 ITA
VALVOLA SF INC C/MAN 3/4	135 ITA
<b>RUBINETTI PASSORAPIDO</b>	
650 RUB. PASSO RAP INT 1	137 EDR
650 RUB. PASSO RAP INT 3/4	137 EDR
<b>RUBINETTI PER ATTACCO LAVATRICE</b>	
475 RUBIN SOTTOL+LAVAT CRO	111 EDR
DISTANZIAT.ATT.LAV 3/4 2PZ	133 ITA
DISTANZIAT.ATT/LAV 3/4 3PZ	133 ITA
RUB SF X LAVATR 1/2X3/4 CR	133 EDR
RUB SNODO ATT LAV 1/2	94 EDR
RUBIN SNODO CIATT LAV 3/8	94 CLB
RUBIN. ATT LAVAT INCL. 1/2	134 TA
RUBINETTO 2 ATT X LAV 1/2	132 TA
RUBINETTO 3V ATT LAV 1/2	134 TA
RUBINETTO DUP AT/LAVAT 1/2	133 TA
RUBINETTO SEMPL LAVATR 1/2	134 TA
RUBINETTO SEMPL LAVATR 3/8	134 TA
RUBINETTO SEMPL ORIZ 1/2	133 TA
RUBINETTO SEMPL ORIZ 3/8	133 TA
SOLO COPPIA PROLUNGHE	133 TA
<b>RUBINETTI PER CASSETTA</b>	
RUBIN. X CASSETTA CR 1/2	132 TA
RUBIN. X CASSETTA CR 3/8	132 TA
<b>RUBINETTI PER CASSETTA KARIBA</b>	
RUBINETTO ARRESTO 1/2 CROM	145 KAR
RUBINETTO ARRESTO 3/8 CR	145 KAR
<b>RUBINETTI PER LAVABO A COLLO CIGNO</b>	
RUBINET.LAVABO C/CIGNO 1/2	94 EDR
<b>RUBINETTI PER SCALDABAGNO</b>	
RUBIN. ARR. SCALD CR 1/2	135 ITA
<b>RUBINETTI SOTTOLAVABO</b>	
405F-02 RUB. C/FIL SNOD BI	111 EDR
FILTRO INOX X RUB 405F-02	111 EDR
RUBIN.SOTTOLAV. M 1/2X10	111 EDR
RUBINETTO C/FIL SNOD CR	111 EDR
<b>RUBINETTO SOTTOSCALDABAGNO</b>	
GRUPPO SCALD + DADO 3/8 10	135 CLB

DESCRIZIONE	PAGINA FORNITORE
<b>RULLO IN PLASTICA DI RICAMBIO PER PORTA ROLOLO</b>	
RULLO PLASTICA C/MOL. BIAN	175 IND
<b>SACCHETTI IGIENICI</b>	
SACCHET IGIENICIX531 C.200	55 GSG
<b>SALDATURA</b>	
BACCHETT. ALTO TEN AG 40%	241 CAS
BACCHETTA LEGA RAME/FOSF	240 CAS
BACCHETTA MEDIO/TEN AG 20%	240 CAS
BACCHETTA X SALDO-BRASATUR	241 CAS
BARATT. PASTA CU 3 REMS	243 COU
BOBINA LEGA UNIV.0 2 GR250	240 CAS
BOMBOLA GAS MAPP	242 CAS
BOMBOLA PER KIT 1450	242 CAS
CANNELLO PRO-LINE 4T	242 CAS
CERCOFLAM BLISTER 5653 EXP	236 COU
DECAPANTE IN GEL X SALD RA	243 CLF
DISSODIDANTE SALDAT.FORTE	241 CAS
DISSODIDANTE X LEGA DOLCE	240 CAS
KIT CANN.C/BOMB.600ML 1450	242 CAS
LANCIA A GAS C/LEV. 60 MM	244 GNA
LANCIA EXPRESS 1655 D.24	236 COU
LANCIA EXPRESS 1656 D.44	236 COU
LEGA DOLCE CASTOLIN IN ROT	240 CAS
LEGA GALAXY 230 BRAS.FORTE	243 BAN
MANICOTTO X TL-4 X PROLINE	242 CAS
MAZZA RICAMBIO X SALDATORE	244 GNA
PANNETTI LUCIDAT ROVLIES	243 COU
PASTA SALD NEW CUPREX 100G	243 FAC
REGOLAT. PER TL-4 PROLINE	242 CAS
SALDAT. A CANNELLO 22MM	244 GNA
SALDAT. CON MAZZA RAME	244 GNA
SET ASFALTISTA CM 60	244 GNA
STERESINA 100G PACCHI 1KG	243 FAC
<b>SALDATURA ACCESSORI</b>	
PINZA ELETT.LECTRA COMBI E	243 RID
RACC. X TUBO GAS X SALDAT.	244 GNA
RACC.OTT.3 VIE GPL 8 MM	244 GNA
TORCIA PIEZOMATIC	236 RID
TUBO FLESSIBILE CM 50	244 GNA
<b>SALISCENDI</b>	
ASTA SALISCENDI C/SUPP CR	162 SOL
SALISCEN ONDAPL C/PS CR/OR	162 SOL
SALISCEN P.SAP DUOCLEAN CR	162 SOL
SALISCEN P.SAP MONOCLEA CR	162 SOL
SALISCENDI P.SAP NORDIN CR	162 SOL
SALISCENDI P.SAP ONDAPL BI	162 SOL
SALISCENDI P.SAP ONDAPL CR	162 SOL
<b>SALISCENDI ACCESSORI</b>	
CENTRALINA SCORR X SALISC	163 SOL
<b>SALISCENDI GROHE</b>	
ASTA DOCCIA 2/GETT P/SA CR	160 GRO
ASTA DOCCIA C/DOC COMPL CR	161 GRO
ASTA DOCCIA C/DOC SOFT CR	161 GRO
ASTA DOCCIA TOP 4 CROMATA	161 GRO
<b>SALISCENDI GROHE RICAMBI</b>	
ASTA DOCCIA 600 MM CHIARA	72 GRO
ASTA DOCCIA CROM C/P 600N1M	160 GRO
DISTANZIATORE X ASTA	161 GRO
PORTASAPONE PER SAL. 74767	72 GRO
PORTASAPONE PER SALISC. CR	161 GRO
PORTASAPONE SCORREVOLE 028	161 GRO
SUPPORTO SCOR X SAL 74767	72 GRO
SUPPORTO SCORREV X 28620	162 GRO
SUPPORTO SCORREVOLE	162 GRO
<b>SALISCENDI ISA</b>	
SALISCENDI C/PORTASAP BIA	163 IAS
<b>SALISCENDI RICAMBI</b>	
SUPPORTO REGOLAB X EURO 90	160 COT
<b>SANITARI PER DISABILI</b>	
KIT SCARICO C X LAVABO	51 SNT
LAVABO SEMIFONTE 64 CM	51 SNT
SANIWAT SCARICO TERRA B.CO	50 SNT
WC-BIDET SANITHAND SC/PAR	51 SNT
WC-BIDET SANITHAND SC/PAV	50 SNT
<b>SANITRIT</b>	
SANIBEST 2	50 SFA
SANIPLUS WC	49 SFA
SANITOP WC	49 SFA
SANITRIT WC	49 SFA
SANIVITE 3	50 SFA
<b>SAPONE LIQUIDO PER DISTRIBUTORI</b>	
SAPONE NEUTRO LAVAM. LT.5	55 GSG
<b>SAUNE</b>	
SAUNA MODELLO F 120	43 FGB

DESCRIZIONE PAGINA FORNITORE

**SCALDABAGNI A GAS MTS**

SCALD. SUPER.FL.BIL.L80V3A	191	MER
SCALD. SUPER.FL.FOR.100L3A	192	MER
SCALD. SUPER.FL.FOR.L80V3A	192	MER
SCALD.SUPER.FL.BIL.L100V3A	191	MER
SCALDAB. GAS 45 L MICRO	190	MER
SCALDAB. GAS PAVIM L 155	190	MER
SCALDAB. GAS PAVIM L 195	190	MER
SCALDAB. GAS PAVIM L 300	190	MER
SCALDAB. GAS VER/PAV L 115	190	MER
SCALDAB. RADIGAS L 100	189	MER
SCALDAB. RADIGAS L50	189	MER
SCALDAB. RADIGAS L80	189	MER
SCALDAB. SUPERCOS. L50V 3A	189	MER
SCALDAB. SUPERCOS. L80V 3A	189	MER
SCALDAB. SUPERCOS.L100V 3A	189	MER

**SCALDABAGNI A GAS SITAM**

SCALDAB. L100 GAS VET 3A	185	SIT
SCALDAB. L120 GAS VET 3A	185	SIT
SCALDAB. L50 GAS VET 3A	185	SIT
SCALDAB. L80 GAS VET 3A	185	SIT

**SCALDABAGNI A LEGNA BOSCHETTI**

SCALDAB. LEGNA PORC 80L 3A	185	BST
----------------------------	-----	-----

**SCALDABAGNI A LEGNA SITAM**

SCALDAB. L80 LEGNA 3A	185	SIT
SCALDAB. L80 LEGNA/ELET 3A	185	SIT

**SCALDABAGNI ACCESSORI**

CURVA SCAR.FUMI 032 FFI	192	MER
KIT SCARICO VERT 0 32 FFI	192	MER
KIT SDOPP.FUMI FFI ACCUM	192	MER
KIT VERT. SGI FF L=1400	194	MER
SDOPPIATORE X SCALD BILANC	191	MER
TUBO PROLUNG.FUMI 032 FFI	192	MER

**SCALDABAGNI ELETTRICI BOSCHETTI**

SCALDAB. ELET VERT 50L 3A	184	BST
SCALDAB. ELET VERT 80L 3A	184	BST

**SCALDABAGNI ELETTRICI MTS**

DOCCIA ELET EUREKA C 13 L	186	MER
DOCCIA ELET EUREKA T 13 L	186	MER
SCALD. PERLA VIEL L 50 3A	188	MER
SCALD. PERLA V/EL L 50 5A	188	MER
SCALD. PERLA VIEL L 80 3A	188	MER
SCALD. PERLA V/EL L 80 5A	188	MER
SCALD. PERLA V/EL L100 5A	188	MER
SCALD.PERLA OR T/EL 80 D3A	188	MER
SCALD.PERLA OR T/EL 80 S3A	188	MER
SCALD.PERLA T/EL DX L1005A	189	MER
SCALD.PERLA T/EL DX L80 5A	189	MER
SCALD.PERLA T/EL SX L1005A	189	MER
SCALD.PERLA T/EL SX L80 5A	189	MER
SCALD.RADI-BLUK EC L50 2A	187	MER
SCALD.RADI-BLUK EC L80 2A	187	MER
SCALD.RADI-BLUK EC L100 2A	187	MER
SCALDAB. PERLINA L10 SP 2A	187	MER
SCALDAB. PERLINA L10 SP 5A	187	MER
SCALDAB. PERLINA L10 ST 2A	187	MER
SCALDAB. PERLINA L10 ST 5A	187	MER
SCALDAB. PERLINA L15 SP 2A	187	MER
SCALDAB. PERLINA L15 SP 5A	187	MER
SCALDAB. PERLINA L15 ST 2A	187	MER
SCALDAB. PERLINA L30 EC 2A	187	MER
SCALDAB. PERLINA L30 SP 5A	187	MER
SCALDAB.BLUK.ORIZ EL 80 2A	187	MER
SCALDAB.PERLINA L10 SP 10A	187	MER
SCALDAB.PERLINA L10 ST 10A	187	MER
SCALDAB.PERLINA L15 SP 10A	187	MER
SCALDAB.PERLINA L30 SP 10A	187	MER

**SCALDABAGNI ELETTRICI SITAM**

SCALDAB. L100 EL VER VET5A	184	SIT
SCALDAB. L50 EL VER VET 5A	184	SIT
SCALDAB. L80 EL VER VET 5A	184	SIT
SCALDAB. L80 ORIZZ ELET 2A	184	SIT
SCALDAB. L80 T/E VER DX 5A	184	SIT
SCALDAB. L80 T/E VER SX 5A	184	SIT
SCALDAB.L80 ORIZ EL VET 5A	185	SIT

**SCALDABAGNI RAPIDI MTS**

SCALD.RAP.COSMOS D10 1A	193	MER
SCALD.RAP.COSMOS D13 1A	193	MER
SCALD.RAP.RHD 10 FI GPL	193	MER

**SCALDABAGNI RAPIDI MTS FLUSSO FORZATO**

SCALD.RAP.FL/FO IONO 10 L	193	MER
SCALD.RAP.FL/FO IONO 13 L	193	MER

**SCALDABAGNI RAPIDI SYLBER**

SCALD UNYC 11 GPL	194	SYL
SCALD UNYC 11 IEB GPL	194	SYL

DESCRIZIONE PAGINA FORNITORE

SCALD UNYC 11 METANO	194	SYL
SCALD UNYC 14 METANO	194	SYL

**SCALDABAGNI RAPIDI SYLBER ACCESSORI**

CURVA COASSIALE 90°	195	SYL
CURVA 0 80 90°	195	SYL
KIT COASSIALE A PARETE	195	SYL
KIT COASSIALE A TETTO	195	SYL
KIT SDOPPIATO	195	SYL
PROLUNGA COASSIALE 0 100	195	SYL
PROLUNGA 0 80	195	SYL
TEGOLA TETTO INCLINATA 41°	195	SYL

**SCALDABAGNI RAPIDI SYLBER FLUSSO FORZATO**

SCALD DEVYL 13 I.E.FF LIQ	195	SYL
SCALD DEVYL 13 I.E.FF MET	195	SYL

**SCALDABAGNI RICAMBI**

ACCENSIONE LAMPADA SPIA	195	SIT
ANODO L350 M6 FLAN	196	SIT
ANODO PASSO M8 NUOVO	196	SIT
FASCETTA+MANICOTTO 0 80 BI	191	MER
GUARNIZIONE ANELLO 125X102	195	SIT
GUARNIZIONE INTEGR X FLANG	195	SIT
GUARNIZIONE 0 98X37	195	SIT
GUARNIZIONE X RESISTENZA	195	SIT
PULSANTE ACCEND.PIEZO	186	MER
TERMOMETRO X APS	196	SIT
TERMOMETRO X SCALD ELETTR	196	SIT
TERMOMETRO X VHST - VE TON	196	SIT
TERMOST X SCALD BLUKER	185	MER
TERMOST X SCALD PERLA	186	MER
TERMOST X SCALD PERLINA	186	MER
TERMOST X VHST LEVA/BIA/BA	196	SIT
TERMOSTATO M270 RS	196	SIT
TERMOSTATO NUOVO SITAM	196	SIT
VALVOLA SCALDAB. GAS ACC	196	SIT
VALVOLA SICUR F3/4 X 1/2M	196	MER

**SCARICHI FLESSIBILI**

ADATT. EMUFLEX 32X1 40	123	EMU
ADATT. EMUFLEX 32X1 75	123	EMU
ADATT. EMUFLEX 32X1.1/440	123	EMU
ADATT. EMUFLEX 32X1.1/4 75	123	EMU
ADATT. EMUFLEX 40X1.1/2 40	123	EMU
ADATT. EMUFLEX 40X1.1/2 75	123	EMU
CANOTTO EST PVC D/OTT 0 26	124	CLB
CANOTTO EST PVC D/OTT 0 32	124	CLB
CANOTTO EST PVC D/OTT 0 40	124	CLB

**SCARICHI FLESSIBILI ACCESSORI**

ANELLO X EASY 1.1/2	124	TIR
ANELLO X EASY 1-1.1/4	124	TIR
BICCH.OTT. 40 OR-32 SALD	125	MAV
BICCH.OTT. 40 OR-40 SALD	125	MAV
BICCH.RID.OTT.320R-26 SALD	124	MAV
CAPPUCCIO OTT.CR H 24 MM	137	TIR
CAPPUCCIO OTT.CR H 32 MM	137	TIR
FLESSIB. EASY SC. 1.1/2X75	124	TIR
FLESSIB. EASY SC. 1.1/4X75	124	TIR
FLESSIB. EASY SCARICO 1X75	124	TIR
MANIC.RID.CR. 32 OR- 26 OR	124	MAV
MANIC.RID.CR. 40 OR- 32 OR	124	MAV
MANICOTTO EASY 32 1-1.1/4	124	TIR
MANICOTTO EASY 40 1.1/2	124	TIR
MANICOTTO OTT.CR.CANOT. 26	124	MAV
MANICOTTO OTT.CR.CANOT. 30	124	MAV
MANICOTTO OTT.CR.CANOT. 32	124	MAV
MANICOTTO OTT.CR.CANOT. 40	124	MAV
RACCORDO C/DADO EASY 1	124	TIR
RACCORDO C/DADO EASY 1.1/2	124	TIR
RACCORDO C/DADO EASY 1.1/4	124	TIR
TUBO X SC. EASY 32 1-1.1/4	124	TIR
TUBO X SC. EASY 40 1.1/2	124	TIR

**SCARICHI PER WC**

ATTACCO WC RIGIDO DIR. 110	123	WAV
ATTACCO WC RIGIDO ECC. 100	123	OLV
CANOTTO ALLACC AL VASO	123	EMU
CURVA TECNICA PER VASI	36	DOL
GUARNIZIONE WC CENTRICA	123	EMU
GUARNIZIONE WC ECCENTRICA	123	EMU
IMBUTO PARA SEMPLICE	139	CLB
MANICOTTO ECC.WC 40X90/110	123	CLB
MANICOTTO PVC ECCENTR WC	123	CLB
PROLUNGA FLES WC SC.100/90	122	BON
PROLUNGA NORMALE CENTRICA	123	CLB
ROSONE X PROLUNGA WC 0 100	122	BON
ROSONE X PROLUNGA WC 0 110	122	BON

**SCOPINI IN PLASTICA RICAMBI**

FIOCCO RIC. X SCOPINO 3814	175	IND
----------------------------	-----	-----

DESCRIZIONE	PAGINA FORNITORE
-------------	------------------

<b>SCOVOLI IN NYLON PER PULIZIA CALDAIE</b>	
SCOVOLO X CALDAIA DA 20 MM A 80 MM	237 RGH
<b>SDOPPIATORE PER SCALDABAGNI RAPIDI MTS</b>	
KIT SDOPP.FUMI SGI FF RAP	194 ATI
<b>SEDILI</b>	
SEDILE ALPINA-QUADRAR BIAN/CHAM	46 FRG
SEDILE CONCA BIAN/CHAMNISO	45 FRG
SEDILE ELISSE -SELVA CHAM/BIAN	45 FRG
SEDILE ITALICA BIAN/CHAMPAGNE	47 FRG
SEDILE LINDA BIAN	45 FRG
SEDILE NUOVO JOLLY BIAN	48 FRG
SEDILE PIEMONTE BIAN	47 FRG
SEDILE RIO BIAN	47 FRG
SEDILE SINTESI BIAN	46 FRG
SEDILE SQUARE BIAN/CHAMP	46 FRG
SEDILE TESI BIAN/CHAM	45 FRG
SEDILE UNIVERSALE	
BIANCO/CHAMPAGNE/NOCE/ROVERENISONE	46 FRG
SEDILE VELARA BIAN	46 FRG
SEDILE ATLANTICO I C BIANCO/NERO	48 C-M
SEDILE CONCA POLIDUR BIANC	45 C-M
SEDILE MIKI BIANCO/NERO	48 DIN
SEDILE RICCIONE BIAN	48 C-M
SEDILE SEDILO BIAN	48 C-M
SEDILE TESI POLIDUR BIANCO	45 C-M
<b>SEDILI DOLOMITE ORIGINALI</b>	
SEDILE ALPINA -QUADRARCO CHAM	46 DOL
SEDILE ALPINA-QUADR. BIAN	43 DOL
SEDILE CLODIA BIAN	43 DOL
SEDILE CORALLO BIAN	43 DOL
SEDILE GARDA BIANCO	43 DOL
SEDILE PERLA BIAN	44 DOL
SEDILE PETRA BIAN	44 DOL
SEDILE RIO BIAN	43 DOL
SEDILE X MONOBL.ZAGAR BIAN	43 DOL
SEDILE ZAGARA BIAN	43 DOL
<b>SEDILI GALASSIA ORIGINALI</b>	
SEDILE ARKE	26 GAL
<b>SEDILI IDEAL STANDARD ORIGINALI</b>	
SEDILE AERO BIANCO	45 DE
SEDILE ALA BIANCO/CHAMPAGNE	45 DE
SEDILE CONCA BIANCO/CHAMPAGNE	45 DE
SEDILE CONCA AVVOLG. BIAN	44 DE
SEDILE ELISSE BIANCO/CHAMPAGNE	45 DE
SEDILE ESEDRA BIAN	44 DE
SEDILE FIORILE BIAN	44 DE
SEDILE LINDA BIANCO	45 DE
SEDILE LINDA CHAMPAGNE	45 DE
SEDILE LIUTO BIANCO/CHAMPAGNE	45 DE
SEDILE SMALL BIAN	46 DE
SEDILE TESI BIANCO	45 DE
<b>SEDILI LAUFEN ORIGINALI</b>	
SEDILE VIENNA BIA	21 LAU
<b>SEDILI OLYMPIA ORIGINALI</b>	
SEDILE PLASTICA AMBRA BIA	26 OLY
<b>SEDILI PER DISABILI</b>	
SEDILE KELA POLIEST.BIANCO	51 SNT
SEDILE MAMO APERTURA MOLLA	48 M-L
SEDILE RIB C/BRAC X DOCCIA	52 THE
SEDILE RIBALTAB. X DOCCIA	52 THE
SEDILE X VASCA 70 CM	53 THE
<b>SEGHE A TAZZA</b>	
KIT SEGHE A TAZZA SET 6PZ	230 RID
<b>SEGHETTI ELETTRICI A GATTOCCIO</b>	
SEGHE ALTERNATIVO 550	234 RID
<b>SEGHE MIGNON A MANO</b>	
ARCHETTO SEGHE. MIGNON	239 CAF
LAMA RICAMBIO METALL.	239 CAF
<b>SFERE PER GALLEGGIANTI</b>	
SFERA PLASTICA PIATTA	141 S-T
SFERA PLASTICA TONDA 0 90	141 S-T
SFERA PLASTICA TONDA 0120	141 S-T
SFERA RAME SALDATA DA 0 85 A 0 250	141 S-T
<b>SGABELLI BAGNO</b>	
SGABELLO CAPRI 0 35 BIAN	173 C-M
SGABELLO TRIX BIAN	171 MPL
<b>SIFONI ESTERNO LAVATRICE</b>	
SIFONE ESTERNO X LAVATRICE	120 GEB
<b>SIFONI INCASSO LAVATRICE</b>	
SIFONE INC LAVAT ANTIRIFLU	121 EMU
SIFONE INCASSO X LAVATRICE	120 GEB
SIFONE LAVATRICE INCASSO	121 EMU
<b>SIFONI IN OTTONE PER LAVABO E BIDET</b>	
SIFONE S C/P 1 25 CM	116 EDR
SIFONE S S/P 1 25 CM	116 EDR

DESCRIZIONE	PAGINA FORNITORE
-------------	------------------

SIFONE S S/P 1.1/4 25 CM	116 EDR
SIFONE S S/P 1.1/4 BIANC	116 GFB
SIFONE U C/P 1 25 CM	116 EDR
SIFONE U S/P 1 25 CM	116 EDR
SIFONE U S/P 1.1/4 25 CM	116 EDR
SIFONE BOTT.C/P 1 25 CM	115 EDR
SIFONE BOTT.S/P 1 25 CM	115 EDR
SIFONE BOTT.S/P 1.1/4 25CM	115 EDR
<b>SIFONI IN PLASTICA PER LAVABO E BIDET</b>	
SIFONE BIDET S 1.1/4	125 EMU
SIFONE LAVAB HL 137 1.1/4	121 DTA
SIFONE LAVABO 5 1.1/4	125 EMU
SIFONE X BIDET 1.1/4 X 40	121 GEB
SIFONE X LAVABO 1.1/4 X 40	121 GEB
<b>SIFONI IN PLASTICA PER LAVELLI</b>	
SIF 1V SPAZIO 1 S/OTT 0 40	128 LIR
SIF 2V SPAZIO 2 S/OTT 0 40	129 LIR
SIF LAVEL 2VIE S/PIL A/LAV	125 EMU
SIFONE 1V CAM.ANTIRIS 0 40	121 GEB
SIFONE 1V X CERAM + LAV.40	127 LIR
SIFONE 1V X CERAMICA 0 35	127 LIR
SIFONE 1V X INOX 035	127 LIR
SIFONE 1V X INOX + LAV.40	127 LIR
SIFONE 2V CAM.ANTIRIS 0 40	121 GEB
SIFONE 2V X CERAM + LAV.40	127 LIR
SIFONE 2V X CERAMICA 0 35	127 LIR
SIFONE 2V X INOX 035	127 LIR
SIFONE 2V X INOX + LAV.40	127 LIR
SIFONE C/OT 1V C/PIL LAVAT	126 GFB
SIFONE C/OT 1V S/PIL LAVAT	126 GFB
SIFONE C/OT 2V C/PIL LAVAT	127 GFB
SIFONE C/OT 2V S/PIL LAVAT	127 GFB
SIFONE LAVELLO 1VIA S/PIL	125 EMU
SIFONE LAVELLO 2VIE S/PIL	125 EMU
<b>SIFONI IN PLASTICA PER LAVELLI ACCESSORI</b>	
ACCESS. SIF. X ALLAC. LAV.	128 LIR
CANOT OTT X SIF DN 40 21CM	129 LIR
CANOTTO OTTONE X SIF 0 35	129 LIR
GUARNIZIONE OR 4375	128 LIR
PROLUNGA JOLLY 40 X 250	128 LIR
RACC.CURVO A STRING. 0 40	128 LIR
RACC.CURVO FILETTATO 1.1/2	128 LIR
RIDUZIONE MOPLN 40X32	129 LIR
TAPPO COPRIF AC/INOX 18/8	128 LIR
TAPPOMANIGLIA 0 50.5	128 LIR
<b>SIFONI IN PLASTICA PER VASCA</b>	
SIFONE VASCA C/SNODO HL500	118 WAV
SIFONE X VASCA C/RACCORDO	121 GEB
SIFONE X VASCA D/OTT 1.1/2	118 OLV
<b>SIFONI IN RAME PER VASCA</b>	
SIFONE VASCA S 1.1/2	118 GFB
<b>SIFONI PER LAVELLI</b>	
SIFONE C/OT 1V C/PIL 1.1/4	126 BON
SIFONE C/OT 1V S/PIL 1.1/4	126 BON
SIFONE C/OT 2V C/PIL 1.1/4	126 BON
SIFONE C/OT 2V S/PIL 1.1/4	126 BON
<b>SIFONI PER TURCA</b>	
SIFONE TURCA 45° APERTO	143 OLV
<b>SOFFIONI DOCCIA</b>	
RIDUTT AUT.DI PORT. 7L 1/2	166 RVR
SOFFIONE ANTICALCARE GAVER	167 COT
SOFFIONE ANTI-SCALE CRO	167 VSN
SOFFIONE APOLLO CRO	167 VSN
SOFFIONE DOC TEAM-JET CR	167 IAS
SOFFIONE DOCCIA A CAMPANA	167 MAV
SOFFIONE DOCCIA LATERALE	168 COT
SOFFIONE DOCCIA STELVIO	167 COT
SOFFIONE ECONOMY CRO	167 VSN
SOFFIONE HIMALAIA 2GETT CR	167 IAS
SOFFIONE MULTI-JET MASS CR	168 IAS
SOFFIONE PLURI-JET MASS CR	168 IAS
SOFFIONE POLO PLUS CRO	168 VSN
SOFFIONE SOFTY JET CRO	167 VSN
SOFFIONE SPIAGGIA CRO	167 VSN
SOFFIONE TIPO PLUS CRO	168 VSN
SOFFIONE TURBO-JET MASS CR	168 IAS
<b>SOFFIONI GROHE</b>	
BRACCIO-SOFF-IDRO CROMATO	169 GRO
SOFFIONE DOCCIA 1/2	167 GRO
SOFFIONE LATERALE DOCCIA	168 GRO
<b>SOLVALINA</b>	
SOLVALINA 0.500 KG	245 SAB
<b>SOTTOLAVELLI MONTEGRAPPA</b>	
MOBILE 3 SPORT 120 DS BIAN	181 MTG
MOBILE 3 SPORT 120 SN BIAN	181 MTG

DESCRIZIONE	PAGINA FORNITORE	DESCRIZIONE	PAGINA FORNITORE
MOBILE LAVAT. 60 CM C/CEST	181 MTG	TAGLIATUBO ROT. 1/8-2 390	220 PAS
MOBILE LAVAT. 60 CM S/CEST	181 MTG	TAGLIATUBO SE X PLAST 127	222 COU
MOBILE LAVAT. 60X50 C/CEST	181 MTG	TAGLIATUBO SE X PLAST 168	222 COU
MOBILE LAVAT. 60X50 S/CEST	181 MTG	TAGLIATUBO SE X PLAST 67	222 COU
SOTTOLAV.120 DX X LAVASTOV	181 MTG	TAGLIATUBO TUBE-CUTTER 28	222 COU
SOTTOLAV.120 SN X LAVASTOV	181 MTG	TAGLIATUBO TUBE-CUTTER 50	222 COU
<b>SOTTOLAVELLI PER CERAMICA</b>		TAGLIATUBO X RAME 0 35 CRO	222 COU
SOTTOL.X CERAM 100X45 BIAN	180 PST	<b>TAPPETI PER DOCCIA INDA</b>	
SOTTOL.X CERAM 100X45 TEAK	180 PST	TAPPETO DOCCIA 55X55 P/B/A	176 IND
SOTTOL.X CERAM 100X50 BIAN	180 PST	TAPPETO VASCA 40X85 BN/P	176 IND
SOTTOL.X CERAM 100X50 TEAK	180 PST	<b>TAPPI COPRIFORO PER SANITARI</b>	
SOTTOL.X CERAM 120X50 BIAN	180 PST	TAPPO C/ROSONE CROM. M1/2	113 VBE
SOTTOL.X CERAM 120X50 TEAK	180 PST	TAPPO COPRIFORO BIANCO	113 EDR
SOTTOL.X CERAM 80X45 BIAN	180 PST	TAPPO COPRIFORO ABS CROMAT	157 ITS
SOTTOL.X CERAM 90X45 BIAN	180 PST	TAPPO COPRIFORO PESANTE CR	113 EDR
<b>SOTTOLAVELLI PER INOX</b>		<b>TAPPI PER PILETTE</b>	
SOTTOL. X INOX 90X50 TEAK	181 PST	TAPPO COMPL GOMMA/CR 0 27	130 LEO
SOTTOL. X INOX 100X50 TEAK	181 PST	TAPPO COMPL GOMMA/CR 0 31	130 LEO
SOTTOL. X INOX 120X50 TEAK	181 PST	TAPPO COMPL GOMMA/CR 0 35	130 LEO
SOTTOL.X INOX 80X50 BIAN	180 PST	TAPPO COMPL GOMMA/CR 0 40	130 LEO
SOTTOL.X INOX 90X50 BIAN	180 PST	TAPPO COMPL GOMMA/CR 0 47	130 LEO
SOTTOL.X INOX 100X50 BIAN	180 PST	TAPPO COMPL GOMMA/CR 0 52	130 LEO
SOTTOL.X INOX 120X50 BIAN	180 PST	TAPPO COMPLETO 0 27 NERO	129 MAV
<b>SPECCHI INDA</b>		TAPPO COMPLETO 0 31 N	129 LEO
SPECCHIO 70X90	178 IND	TAPPO COMPLETO 0 35 N	129 LEO
SPECCHIO C/BISEL. 60X80	178 IND	TAPPO COMPLETO 0 40 N	129 LEO
SPECCHIO C/BISEL. 60X80	178 IND	TAPPO COMPLETO 0 47 NERO	129 MAV
SPECCHIO MET 50X51 CROM	178 IND	TAPPO COMPLETO 0 52 NERO	129 MAV
SPECCHIO MET 60X51 CROM	178 IND	TAPPO COPER. PILETTA 1.1/4	117 CLB
<b>SPECCHI PER DISABILI</b>		TAPPO SALTARELLO 1	117 CLB
SPECCHIO INCLINABILE 60X50	53 THE	TAPPO SALTARELLO 1.1/4	117 CLB
<b>SPECCHI PLASTICA</b>		TAPPO X PILET SALTARELLO 1	117 TIR
SPECCHIO 3 LUC. 68X56 BIAN	170 MPL	<b>TEFLON</b>	
<b>SPORTELLI PER CONTATORI</b>		NASTRO SIGIL LOCTITE55 150	245 LOC
SPORTELLO CONT INOX 30X40	201 FRR	TEFLON 1 12 M PROFESS	244 FAC
SPORTELLO CONT INOX 40X50	201 FRR	TEFLON 1/2 50 M PROFESS	244 FAC
SPORTELLO CONT ZINC 40X50	201 FRR	TEFLON 1/2 X 12 MT	244 R-M
SPORTELLO CONT ZINC 45X60	201 FRR	TEFLON 3/4 12 M PROFESS	244 FAC
SPORTELLO CONT ZINC 66X50	201 FRR	TEFLON 3/4 50 M PROFESS	244 FAC
SPORTELLO STAGNO 40X35	201 FRR	TEFLON LIQUIDO 100 G	244 FAC
<b>STAFFE PER SANITARI SOSPESI</b>		TEFLON LIQUIDO 100 G	244 MAN
CAPPELLOTTO-RONDELLA PVC	27 DIV	TEFLON LIQUIDO 250 G	244 MAN
COPIA STAFFE/SOST PAVIM	21 IDE	TEFLON X GAS 3/4 X 15 M	245 R-M
SOSTEGNO UNIV X BID MOD H	27 DIV	TEFLON X VAPORE H12X13.7ML	245 FAC
SOSTEGNO UNIV X VASO MOD P	27 DIV	<b>TELAI PER PREDISPOSIZIONE INCASSO GRIGLIETTE</b>	
SOSTEGNO WC + SOST CAS GEB	27 DIV	TELAIO LAM.ZINC MM 104X104	199 EDP
STAFFA METAL.VASO/BID SOSP	21 IDE	TELAIO LAM.ZINC MM 146X146	199 EDP
<b>STAFFE PER SANITARI SOSPESI GEBERIT</b>		TELAIO LAM.ZINC MM 146X83	199 EDP
COMBIFIX X BIDET	153 GEB	<b>TELO PER DOCCIA CON PILETTA SCARICO</b>	
COMBIFIX X VASO SOS	153 GEB	PIATTO DOCCIA+SIF 120X110	118 WAV
SUPPORTI X COMBIFIX	153 GEB	<b>TENDE PER DOCCIA</b>	
<b>STAGNO</b>		TENDA VIN 11 GANCI 180X200	175 IND
STAGNO VERGHE 33%	243 t)-0	TENDA VIN 15 GANCI 240X200	175 IND
STAGNO VERGHE 50%	243 D-0	TENDA VIN 8 GANCI 120X200	175 IND
STAGNO VERGINE VERGHE	243 D-0	<b>TERMOCOPPIE SITAM</b>	
<b>STRAMAZZI PER CASSETTE</b>		TERMOCOPPIA	196 SIT
STRAMAZZO STIR-BLITZ	155 CLB	<b>TERMOCOPPIE UNIVERSALI</b>	
STRAMAZZO TAGO	149 LEO	TERMOCOPPIA UNIFIC. L 900	186 CLB
STRAMAZZO DORA	150 LEO	TERMOCOPPIA UNIFIC. L1000	186 CLB
<b>STUCCO PER GUARNITURA ALTE TEMPERATURE</b>		TERMOCOPPIA UNIVERS. L 600	186 CLB
MANGRAFIT STUCCO CALD. 1KG	247 FA.0	<b>TERMOMETRI DIGITALI</b>	
<b>STUCCO PER GUARNITURA PILETTE</b>		TERMOMETRO DIGIT -50°+150°	216 VEM
KOBALSTUCCO BARATTOLI 1 KG	247 FAC	<b>TRONCATRICI</b>	
<b>STURALAVANDINI</b>		TRONCATRICE 590L 14 - 230V	229 RID
STURALAVANDINO PANGO	246 P-0	<b>TUBETTI CROMATI</b>	
<b>SUPPOTI PER IRRIGATORI A BATTENTE</b>		TUBO RAME RIC. CR 0 10 5M	110 EDR
SLITTA X IRRIGAT ATTAC 1/2	204 IPR	TUBO RAME RIC. CR 0 12 5M	110 EDR
SUPPORTO X IRRIG FIL 1	204 M-M	TUBO RAME RIC. CR 0 14 5M	110 EDR
SUPPORTO X IRRIG FIL 3/4	204 M-M	<b>TUBETTI CROMATI CON CARTELLA</b>	
SUPPORTO X IRRIG FIL 1.1/4	204 M-M	ATTAC. LISCIO 0 10 1/2X30	109 EDR
<b>TAGLIATUBI</b>		ATTAC. LISCIO 0 10 1/2X50	109 EDR
TAGLIAT. 4 ROT. 3/4-2 42-A	221 RID	ATTAC. LISCIO 0 10 1/2X100	109 EDR
TAGLIAT.150 L RAME035 150L	221 RID	<b>TUBI DI CACCIATA DA INCASSO</b>	
TAGLIAT.205 RAME060 205	221 RID	TUBO CACCIATA INCASSO REG	123 EMU
TAGLIAT.AZ.RAP.PLAS63 152P	222 RID	TUBO DI RACC.CASS.X WC EST	143 IGP
TAGLIAT.MIDGET RAME016 103	221 RID	TUBO DI RACC.CASS.X WC INC	143 IGP
TAGLIAT.MIDGET RAME024 104	221 RID	TUBO DI SCAR INF DIRXTUR/E	143 IGP
TAGLIAT.X ACC. 0 100 4-S	221 RID	TUBO DI SCARICO INF X WC	143 IGP
TAGLIAT.X ACC. 0 50 2-A	221 RID	TUBO DI SCARICO INFXTUR/I	143 IGP
TAGLIAT.X ACC. 0 75 3-S	221 RID	<b>TUBI PER CARICO LAVATRICE</b>	
TAGLIATUBI PER PE 140	223 IDH	TUBO CARICO FF 1.00 M	119 COT
TAGLIATUBO 101	221 RID	TUBO CARICO FF 1.50 M	119 COT
TAGLIATUBO 726 PLAST 050	222 COU	TUBO CARICO FF 2.00 M	119 COT
TAGLIATUBO A MANO 28 MM	222 POG	TUBO CARICO FF 2.50 M	119 COT
TAGLIATUBO DA 1/8 A 5/8	222 VLX	TUBO CARICO FF 3.00 M	119 COT





DESCRIZIONE	PAGINA	FORNITORE
<b>TUBI PER CASSETTA GEBERIT</b>		
CANOTTO ALLAC. VASO BIANCO	153	GEB
CANOTTO ALLAC. VASO CROMAT	153	GEB
TUBO RISCIACQUO BIANCO	154	GEB
<b>TUBI PER CASSETTA KARIBA</b>		
TUBO 2 PZ BIANCO	146	KAR
TUBO 2 PZ CHAMPAGNE	146	KAR
TUBO 50/32X100 BIANCO	146	KAR
TUBO SCAR 50X40X325 BIANCO	146	KAR
<b>TUBI PER CASSETTA TAGO</b>		
TUBO PLASTICA TAGO L.60	149	FAI
<b>TUBI PER IRRIGAZIONE</b>		
FITTONCINI X CAPILL.1/4	212	CLR
RACCORDO PER TUBO 1/2-1/4	212	CLR
TUBO CAPILLARE M 20 1/4	211	CLR
TUBO COLLETTORE M 50 1/2	211	CLR
<b>TUBI PER SCARICO LAVATRICE</b>		
TUBO SCARICO 1.5 M	119	COT
TUBO SCARICO 2.0 M	119	COT
TUBO SCARICO 2.5 M	119	COT
TUBO SCARICO 3.0 M	119	COT
<b>TUBI REGGITENDA</b>		
ATTACCO A SOFFITTO 60 CROM	175	ND
TUBO DOC. U 70X70X70 CROM	174	ND
TUBO DOCCIA 60/90 CROM	174	ND
TUBO DOCCIA 85/135 CROM	174	ND
TUBO DOCCIA 130/220 CROM	174	ND
TUBO DOCCIA L 70X170 CROM	174	ND
TUBO DOCCIA L 80X80 CROM	174	ND
<b>TUBO PIEGHETTATO ALLUMINIO</b>		
TUBO PIEGHETT ALLUM DA Ø 80 A Ø 200	200	MRL
<b>TUBO PIEGHETTATO ALLUMINIO COLORE BIANCO</b>		
TUBO PIEGHETT BIAN DA Ø 80 A Ø 160	200	MRL
<b>TUBO PIEGHETTATO INOX</b>		
TUBO PIEG. INOX 1.5 M DA Ø 140 A Ø 300	200	MRL
<b>TURCHE ACCESSORI</b>		
SPANDIACQUA ABS X TURCA	60	SIT
SPARTIACQUE FUNG ATT/POST	107	RAF
SPARTIACQUE FUNG ATTNERI	107	RAF
SPARTIACQUE TURCA CURV 1	107	TRE
SPARTIACQUE TURCA DIR. 1	107	TRE
<b>TURCHE CERAMICA DOLOMITE</b>		
TURCA ARGENTINA	36	DOL
TURCA BELLUNO BIAN	36	DOL
<b>TURCHE CERAMICA DOLOMITE ACCESSORI</b>		
SIFONE X TURCA ARGENT 0100	36	DOL
<b>TURCHE CERAMICA GALASSIA</b>		
TURCA DIADORA BIAN	24	GAL
TURCA MICENE BIAN	24	GAL
TURCA PARNASO BIAN	23	GAL
<b>TURCHE CERAMICA IDEAL STANDARD</b>		
TURCA NONCELLO BIAN	20	IDE
<b>TURCHE IN ACCIAIO SMALTATE</b>		
TURCA ACCIAIO SMALT 65X55	60	SIT
<b>UTENSILERIA PER FRIGORISTI</b>		
ADDITIVO X CLIM/REFR 120ML	217	REC
BILANCIA ELETT.DOP.CIRC.	219	REC
BOMBOLA VUOTA 12 L FREON22	218	REC
CACCIAVITE X VALVOL CN 1	215	REC
FLESSIB ADAT X TUBET ADDIT	217	REC
GRUP MANOMETRICO 2VIE 5/16	218	REC
LAMPADA CERCAFUGHE TX 12A	216	REC
LAMPADA STROBOSC.220V 100W	217	REC
PETTINE X ALETTE PA 6	219	REC
PINZA SCHIACCIATUBI X FRIG	215	COU
PISTOLA X ADDITIVO	217	REC
PULITORE DI ADDITIVO 960ML	218	REC
SERIE 3 FLESS CNALV INTER	218	REC
SERIE 3 TUBI FLES 3W60X1.5	214	REC
SIGILLANTE X FIL LEAK LOCK	220	REC
TUBO 1/4 FLES.1.5M SQ C/DE	214	REC
TUBO 1/4 FLES.1.5MFF DIRITT	214	REC
VACUOMETRO DIGIT TIF 9450D	219	REC
<b>UTENSILERIA PER FRIGORISTI E RICAMBI</b>		
ASTICELLA PYREX TIPO LUNGO	214	REC
BOMBOLETTA PROP LP175 G400	216	REC
CILINDRO RICAMBIO EST KCE2	214	REC
OLIO ESTERE LATTIN 1L SW68	218	REC
OLIO ESTERE SW68 XR410 1LT	218	REC
OLIO POMPA VUOTO 1KG K1L	214	REC
OLIO X POMPA MINER.KG 3.7	214	REC
PELLICOLA X CILINDRO K2 M	214	REC
RUBINETTO RIC X CILIND K2M	214	REC
SERIE DEPRESS.X TUBI 1OPZZ	218	REC

DESCRIZIONE	PAGINA	FORNITORE
SERIE GUARN.X TUBO 1/4 10P	218	REC
VALVOLA SICUREZZA V24	214	REC
<b>VALVOLA SICUREZZA PER SCALDABAGNI</b>		
VALVOLA SICUREZZA MF 1/2	196	CLB
VALVOLA SICUREZZA MF 3/8	196	CLB
VALVOLA X SCALD.SIC MF 3/4	196	TIR
<b>VASCHE IN ACCIAIO</b>		
VASCAAC 22/10 BIAN 105X65	59	MER
VASCA AC 22/10 BIAN 120X70	60	MER
VASCAAC 22/10 BIAN 140X65	60	MER
VASCAAC 22/10 BIAN 140X70	60	MER
VASCA AC 22/10 BIAN 150X70	60	MER
VASCAAC 22/10 BIAN 160X65	60	MER
VASCAAC 22/10 BIAN 160X70	60	MER
VASCAAC 22/10 BIAN 170X70	60	MER
VASCA AC 40/10 BIAN 160X70	60	MER
VASCAAC 40/10 BIAN 170X70	60	MER
<b>VASCHE IN METACRILATO</b>		
VASCA AMACA 160X70 BIA	62	TE
VASCA AMACA 160X70 B.IS	62	TE
VASCA AMACA 170X70 BIA	62	TE
VASCA AMACA 170X70 B.IS	62	TE
VASCA AMARANTE 120X70 B.I	60	TE
VASCA AMARANTE 120X70 BIA	60	TE
VASCA AMARANTE 140X70 B.I	61	TE
VASCA AMARANTE 140X70 BIA	61	TE
VASCA CANOA 170X70 INC.B.I	61	TE
VASCA CANOA 170X70 INC.BIA	61	TE
VASCA CANOA 170X80 INC.B.I	61	TE
VASCA CANOA 170X80 INC.BIA	61	TE
VASCA EGEE+TEL 160X70 B.I	61	TE
VASCA EGEE+TEL 160X70 BIA	61	TE
VASCA EGEE+TEL 170X70 B.I	61	TE
VASCA GOCCIA 105X70 B.I	61	TE
VASCA GOCCIA 105X70 BIA	61	TE
VASCA GOCCIA 120X70 B.I	62	TE
VASCA GOCCIA 120X70 BIA	62	TE
VASCA GOCCIA 140X70 B.I	62	TE
VASCA GOCCIA 140X70 BIA	62	TE
VASCA GOCCIA 150X70 B.I	62	TE
VASCA GOCCIA 150X70 BIA	62	TE
VASCA MICEA 160X70 INC.B.I	61	TE
VASCA MICEA 160X70 INC.BIA	61	TE
<b>VASCHE IN METACRILATO ACCESSORI</b>		
GREENET IGIENIZZANTE IDRO	63	TE
KALNET DETERGENTE X ACRIL.	63	TE
KIT FISSAGG MURO X VAS/ACR	63	TE
KIT MANUTENZ.VASCA/ACR/IDR	63	TE
PANNELLO FRONT. 160X6013.1	62	TE
PANNELLO FRONT. 170X60 B.I	62	TE
PANNELLO FRONT. 170X60 BIA	62	TE
PANNELLO LATER. 70X60 B.I	62	TE
PIED.RET.X VASCA MICEA 170	61	TE
PROFILO X VASCA BIAN	63	JAC
PROFILO X VASCA BIA/IS	63	JAC
TELAIO X VASCA ACR 170X70	62	ITE
<b>VASO DAASILO BAMBI IDEAL STANDARD</b>		
VASO BAMBY PAVIMENTO BIAN	19	IDE
<b>VIDEOCAMERE ISPEZIONI</b>		
VIDEOCAMERA X ISPEZIONI	235	RID
<b>VITONE UNIVERSALE</b>		
KIT VITONE UNIVERSALE	137	TIR
MANIGLIA CR X KIT VIT UNIV	137	TIR
<b>VITONI PER BONOMI</b>		
VITONE	100	MPB
<b>VITONI PER GROHE</b>		
VITONE 1/2	77	GRO
VITONE CER CARBODUR	76	GRO
<b>VITONI PER PASSI RAPIDI</b>		
VITONE UNIV PAS RAP 026	137	TIR
VITONE UNIV PAS RAP 027	137	TIR
VITONE UNIV PAS RAP 029	137	TIR
<b>VITONI PER SOL</b>		
VITONE CERAMICO 180° MEDEA	90	SOL
VITONE X SERIE RIVA 1/2	94	SOL
<b>VUOTATOLO IDEAL STANDARD</b>		
VUOTATOLO COSMA BIAN	20	IDE
<b>VUOTATOLO IDEAL STANDARD ACCESSORI</b>		
GRIGLIA RIBALTAB CROMATA	20	IDE



